

## Radial gripper DHRS

**FESTO**

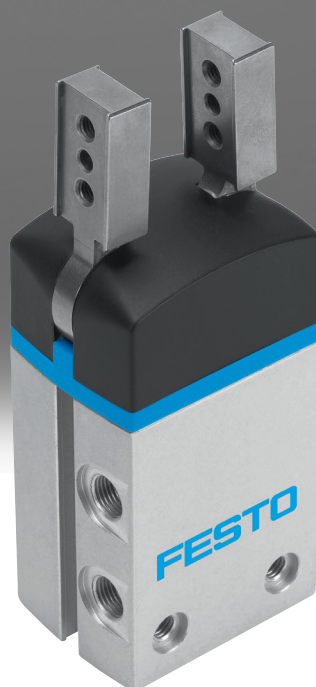

## Characteristics

### At a glance

[Further information → dhrs](#)

General information:

- Lateral gripper jaw support for high torque loads
- Self-centring
- Gripper jaw centring options
- Max. repetition accuracy
- Gripping force backup
- Internal fixed flow control
- Wide range of adaptation options on the drives

Sensors:

- Adaptable position sensor for small gripper sizes
- Integrated proximity switches for medium and large gripper sizes

Flexible range of applications:

- Can be used as a double-acting and single-acting gripper
- Compression spring for supporting or retaining the gripping forces
- Suitable for external and internal gripping

These grippers are not designed for the following or similar application examples:

- Machining
- Aggressive media
- Grinding dust
- Welding spatter

### Engineering tools

[Further information → engineering tools](#)



Save time with engineering tools Smart Engineering for the optimal solution. Our goal is to increase your productivity. Our engineering tools play an integral part in this. They help you size your system correctly, tap into unimagined productivity reserves and generate additional productivity along the entire value chain. In every phase of your project, from the initial contact to the modernisation of your machine, you will come across a number of different tools which will be of use to you.

Gripper selection:

- This tool helps you to select the right grippers by simply entering the exact parameters for your application

### Diagrams

[Further information → dhrs](#)



The diagrams shown in this document are also available online. These can be used to display precise values.

### Position sensing

[A] For proximity sensor

By using proximity switches, any position can be detected.

### Gripping force backup

[NC] N/O contact

Closed by spring force in depressurised state

## Type code

001	Series
DHRS	Radial gripper

002	Size [mm]
10	10
16	16
25	25
32	32
40	40

003	Position sensing
A	For proximity sensor

004	Gripping force backup
	None
NC	N/O contact

## Datasheet

General technical data										
Size	10	16	25	32	40					
Design	Force pilot operated motion sequence									
Mode of operation	Double-acting									
Gripper function	Radial									
Gripping force backup	None	None N/O contact								
Number of gripper jaws	2									
Max. opening angle <sup>1)</sup>	180 deg									
Pneumatic connection	M3			M5		G1/8				
Repetition accuracy, gripper <sup>2)</sup>	≤0.1 mm									
Max. replacement accuracy	≤0.2 mm									
Max. operating frequency of gripper	≤4 Hz			≤3 Hz			≤2 Hz			
Rotationally symmetrical	≤0.2 mm									
Position detection	Via Hall sensor		Via proximity switch							
Type of mounting	Either: Via female thread and centring sleeve Via through-hole and centring sleeve									
Mounting position	optional									

1) At an operating pressure of 0.8 MPa (8 bar, 116 psi)

2) End-position drift under constant operating conditions with 100 consecutive strokes in the direction of movement of the gripper jaws

Operating and environmental conditions									
Size	10	16	25	32	40				
Gripping force backup	None	N/O contact	None	N/O contact	None	N/O contact	None	N/O contact	
Operating pressure	2 ... 8 bar	4 ... 8 bar	2 ... 8 bar	4 ... 8 bar	2 ... 8 bar	4 ... 8 bar	2 ... 8 bar	4 ... 8 bar	
Operating medium	Compressed air to ISO 8573-1:2010 [7:4:4]								
Note on operating and pilot medium	Lubricated operation possible (in which case lubricated operation will always be required)								
Ambient temperature <sup>1)</sup>	5 ... 60°C								
Corrosion resistance class CRC <sup>2)</sup>	1 - Low corrosion stress								

1) Note the operating range of the proximity switches

2) More information: [www.festo.com/x/topic/crc](http://www.festo.com/x/topic/crc)

Weight									
Size	10	16	25	32	40				
Gripping force backup	None	N/O contact	None	N/O contact	None	N/O contact	None	N/O contact	
Product weight	44 g	114 g	118 g	270 g	277 g	480 g	490 g	829 g	844 g

Materials	
Material housing	Hard anodised wrought aluminium alloy
Material gripper jaws	High-alloy steel
Material cover cap	PA
Note on materials	RoHS-compliant

## Datasheet

## Gripping torque

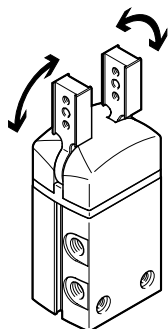

The gripping torque is not constant across the opening angle.

Size	10	16	25	32	40
Total gripping torque at 0.6 MPa (6 bar, 87 psi), opening	21 Ncm	62 Ncm	233 Ncm	423 Ncm	725 Ncm
Total gripper torque, closing, 0.6 MPa (6 bar, 87 psi)	15 Ncm	55 Ncm	215 Ncm	390 Ncm	660 Ncm

## Characteristic load values at the gripper jaws

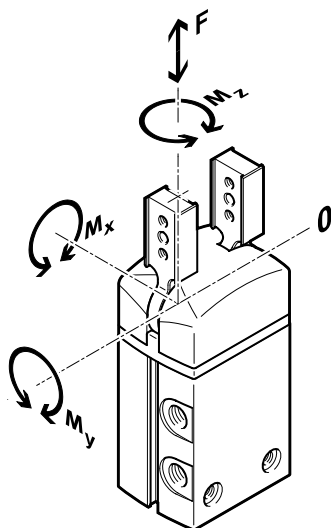

The indicated permissible forces and torques apply to one gripper jaw. They include the lever arm, additional applied loads created by the workpiece or external gripper fingers and acceleration forces occurring during the movement.

The zero coordinate line (gripper jaw guide) must be taken into consideration when calculating torques.

Size	10	16	25	32	40
Max. force on gripper jaw $F_z$ static	30 N	40 N	75 N	120 N	200 N
Max. torque at gripper $M_x$ static	0.8 Nm	1.3 Nm	3.2 Nm	6.2 Nm	14 Nm
Max. torque at gripper $M_y$ static	0.8 Nm	1.3 Nm	3.2 Nm	6.2 Nm	14 Nm
Max. torque at gripper $M_z$ static	0.8 Nm	1.3 Nm	3.2 Nm	6.2 Nm	14 Nm

Datasheet

Gripping force FH per gripper jaw as a function of operating pressure and lever arm x

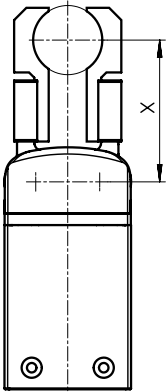

The gripping forces as a function of operating pressure and lever arm can be determined from the following graphs.

The gripping torque is not constant across the opening angle.

Sizing software for gripper selection → <https://www.festo.com/x/topic/eng>

Gripping force FH per gripper jaw as a function of operating pressure and lever arm x – External gripping (closing), double-acting – DHRS-10

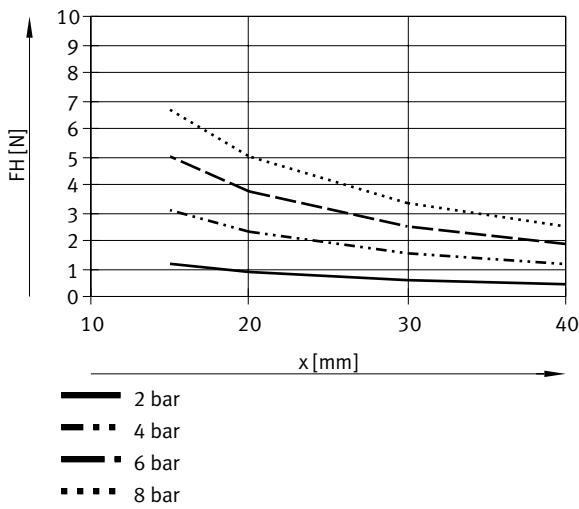

Gripping force FH per gripper jaw as a function of operating pressure and lever arm x – External gripping (closing), double-acting – DHRS-16

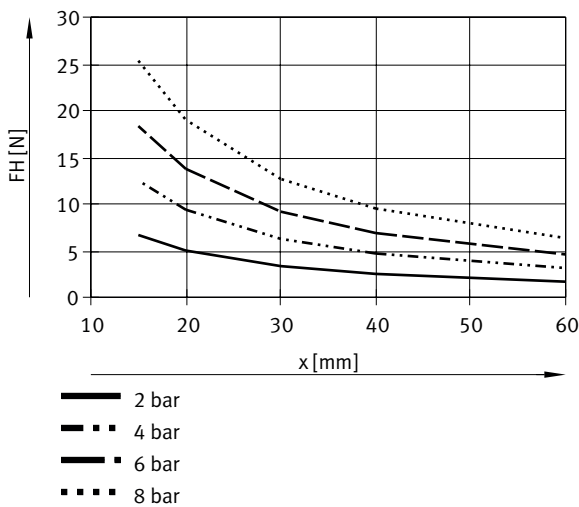

## Datasheet

## Gripping force FH per gripper jaw as a function of operating pressure and lever arm x – External gripping (closing), double-acting – DHRS-25

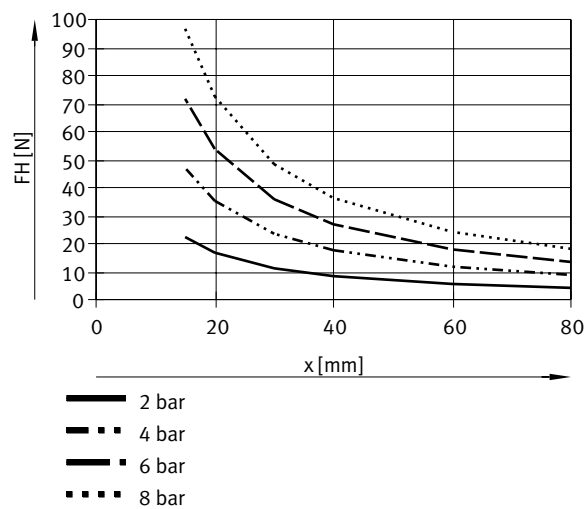

## Gripping force FH per gripper jaw as a function of operating pressure and lever arm x – External gripping (closing), double-acting – DHRS-32

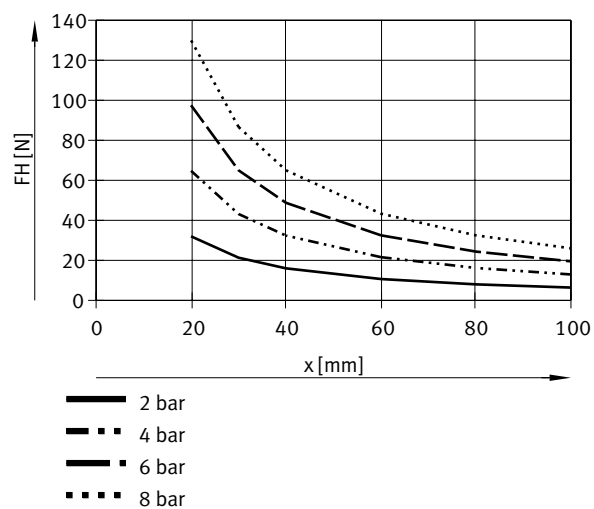

Datasheet

Gripping force FH per gripper jaw as a function of operating pressure and lever arm x – External gripping (closing), double-acting – DHRS-40

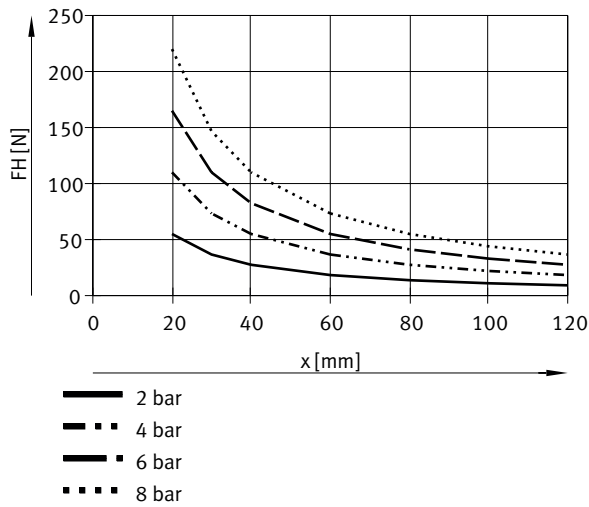

Gripping force FH per gripper jaw as a function of operating pressure and lever arm x – Internal gripping (opening), double-acting – DHRS-10

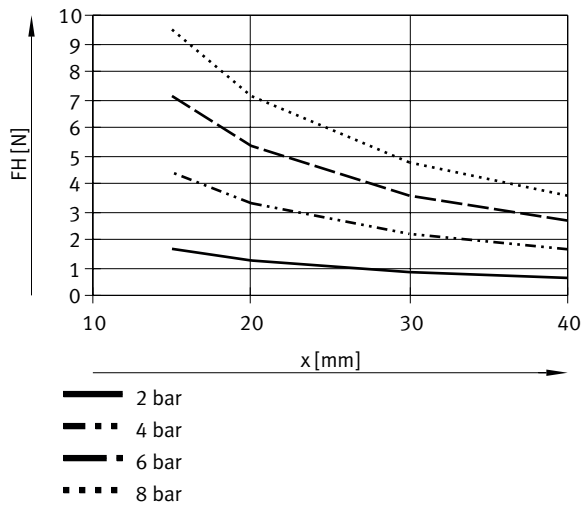



## Datasheet

### Gripping force FH per gripper jaw as a function of operating pressure and lever arm x – Internal gripping (opening), double-acting – DHRS-16

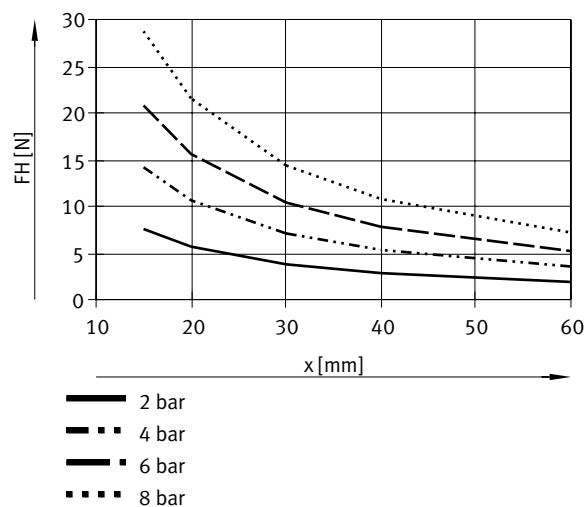

### Gripping force FH per gripper jaw as a function of operating pressure and lever arm x – Internal gripping (opening), double-acting – DHRS-25

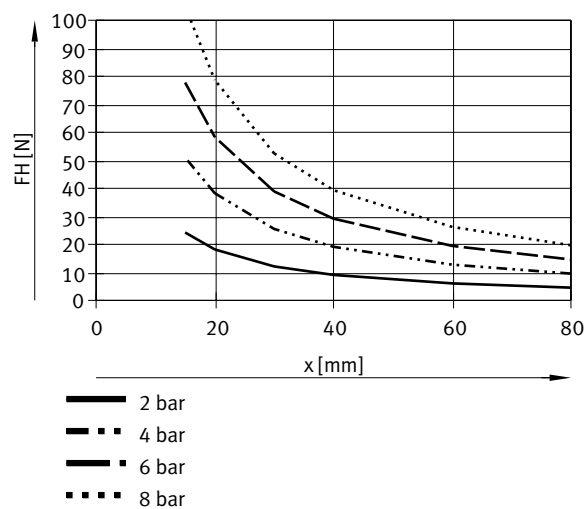

Datasheet

Gripping force FH per gripper jaw as a function of operating pressure and lever arm x – Internal gripping (opening), double-acting – DHRS-32

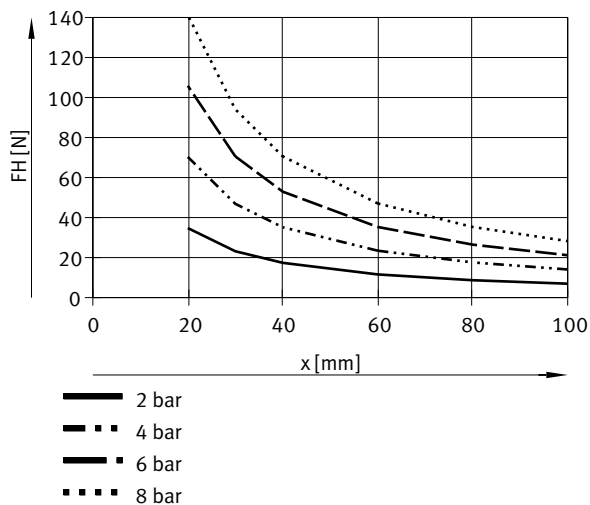

Gripping force FH per gripper jaw as a function of operating pressure and lever arm x – Internal gripping (opening), double-acting – DHRS-40

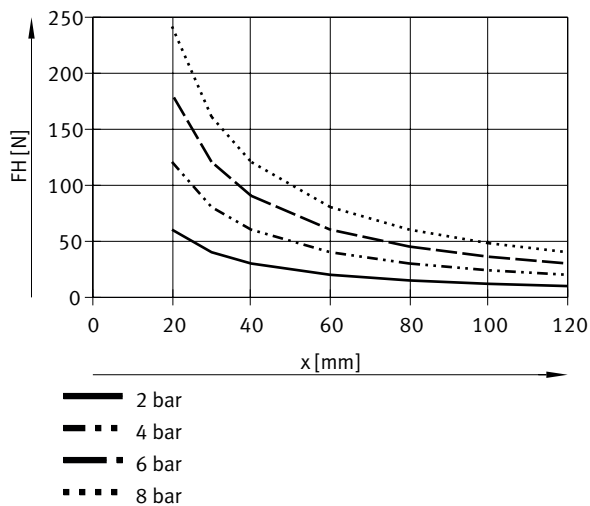

## Datasheet

Gripping force FH per gripper jaw at 0.6 MPa (6 bar, 87 psi) as a function of lever arm x and eccentricity a and b

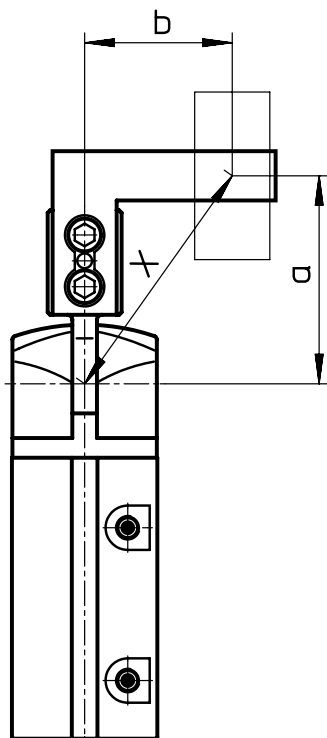

Gripping force FH per gripper jaw at 0.6 MPa (6 bar, 87 psi) as a function of lever arm x and eccentricity a and b

$$x = \sqrt{a^2 + b^2} = \sqrt{25^2 + 20^2} = 32 \text{ mm}$$

The formula (on the left) must be used to calculate the lever arm x with eccentric gripping.

The gripping force FH can then be read from the graphs using the calculated value x.

Calculation example:

Assuming:

Distance a = 25 mm

Distance b = 20 mm

To be determined:

The gripping force at 6 bar with a DHRS-16, used as an external gripper.

Datasheet

Gripping force FH per gripper jaw at 0.6 MPa (6 bar, 87 psi) as a function of lever arm x and eccentricity a and b

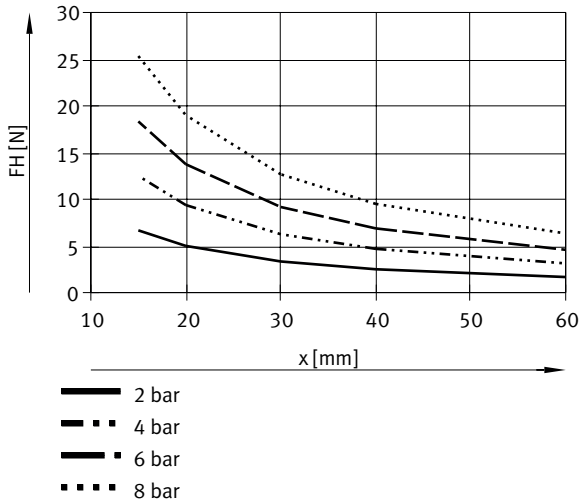

The graph gives a value of FH = 8 N for the gripping force.

Torque curve M as a function of opening angle

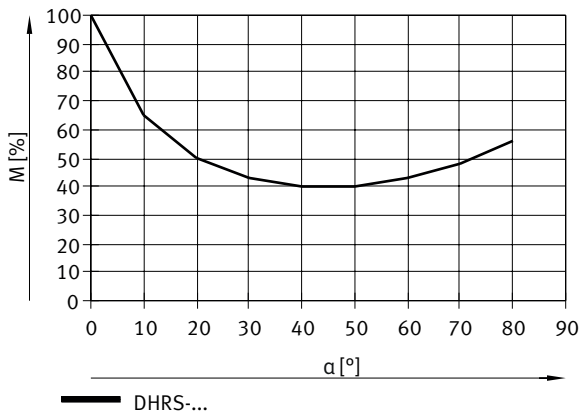

The drive principle of the gripper jaws means that the torque is not constant across the opening angle. The percentage available in each case can be calculated in the graph.

Opening angle of 0° means: parallel gripper jaw position

Spring torque MF as a function of opening angle

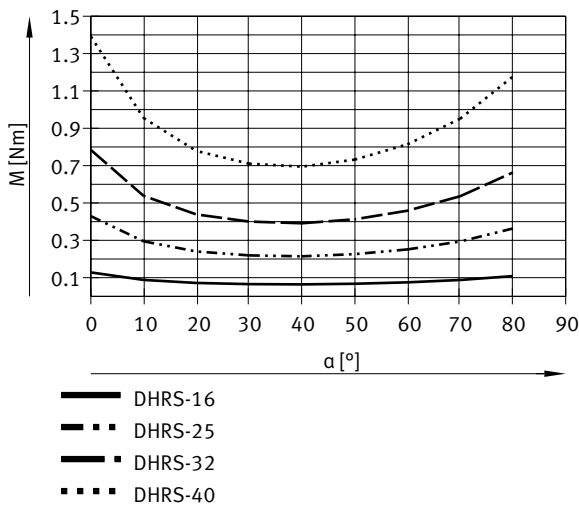

## Datasheet

### Determining the actual gripping torques $MGr_{total}$ for DHRS-...-NC as a function of application

Depending on the requirements, the radial gripper with integrated spring, type DHRS-...-NC (closing gripping force backup), can be used as a:

- Single-acting gripper
- Gripper with gripping force backup and
- Gripper with gripping force retention

To calculate the available gripping torque  $MGr_{total}$  (per gripper jaw), the gripping force  $FH$ , the torque curve  $M$  and the spring torque  $MF$  must be combined accordingly.

$$MGr = FH * x * M [\%]$$

$MGr$  = Gripping torque

$FH$  = Gripping force

$x$  = Lever arm

$M$  = Torque curve

### Determining the actual gripping torques $MGr_{total}$ for DHRS-...-NC as a function of the application – application

Single-acting:

- Gripping with spring force:  $MGr_{total} = MF$
- Gripping with pressure force:  $MGr_{total} = MGr - MF$

Gripping force backup:

- Gripping with pressure and spring force:  $MGr_{total} = MGr + MF$

Gripping force retention

- Gripping with spring force:  $MGr_{total} = MF$

### Mass moments of inertia

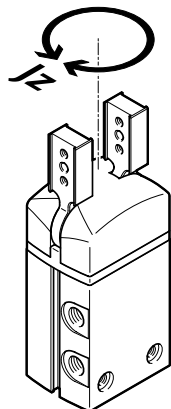

Mass moment of inertia of the radial gripper in relation to the central axis, without external gripper fingers, with no load.

Size	10	16	25	32	40
Gripping force backup	None	N/O contact	None	N/O contact	N/O contact
Mass moment of inertia	0.03 kgcm <sup>2</sup>	0.14 kgcm <sup>2</sup>	0.15 kgcm <sup>2</sup>	0.69 kgcm <sup>2</sup>	0.71 kgcm <sup>2</sup>

## Datasheet

### Opening and closing times

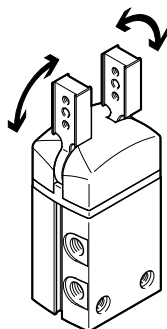

The indicated opening and closing times [ms] were measured at room temperature, at an operating pressure of 0.6 MPa (6 bar, 87 psi) and with the gripper installed horizontally without additional gripper fingers (mean values shown). The grippers must be throttled for larger weights. Opening and closing times must then be adjusted accordingly.

Size	10	16	25	32	40
Gripping force backup	None	N/O contact	None	N/O contact	None
Min. opening time at 0.6 MPa (6 bar, 87 psi)	35 ms	61 ms	75 ms	102 ms	150 ms
Min. closing time at 0.6 MPa (6 bar, 87 psi)	91 ms	63 ms	43 ms	105 ms	96 ms

### Opening and closing times $t$ to be set at 0.6 MPa (6 bar, 87 psi) as a function of mass moment of inertia of the gripper fingers – DHRS-10

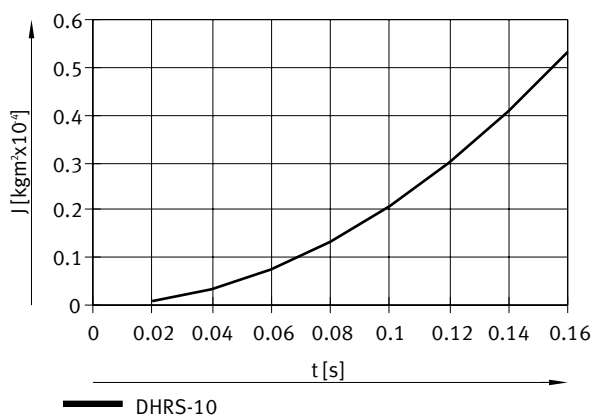

### Opening and closing times $t$ to be set at 0.6 MPa (6 bar, 87 psi) as a function of mass moment of inertia of the gripper fingers – DHRS-16

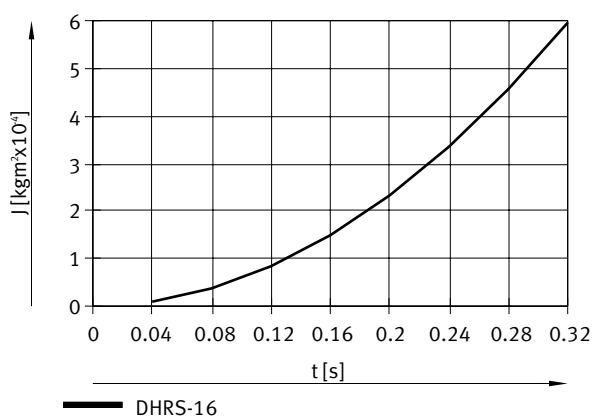

## Datasheet

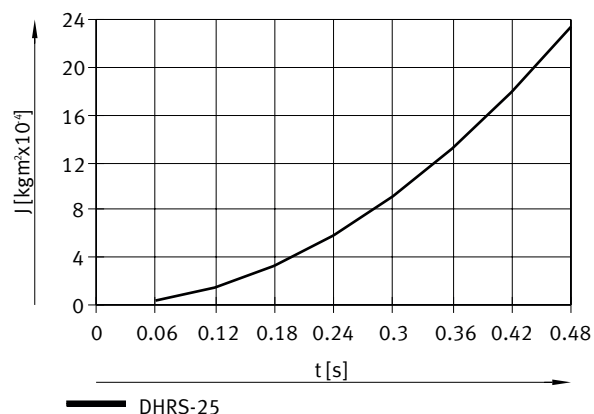
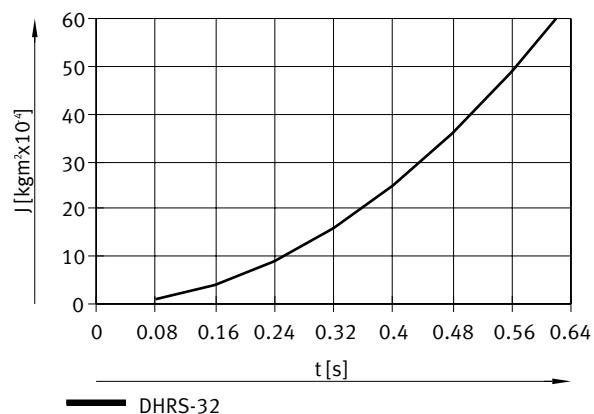
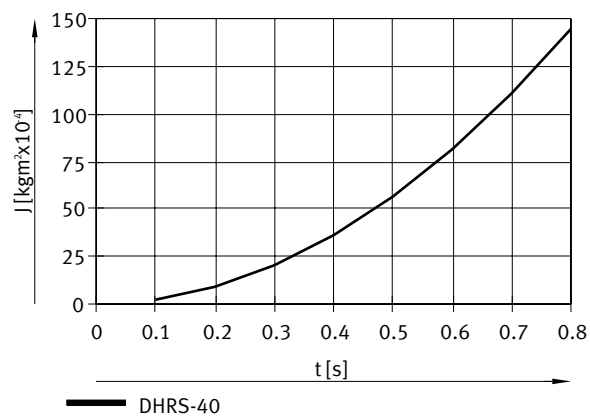
Opening and closing times  $t$  to be set at 0.6 MPa (6 bar, 87 psi) as a function of mass moment of inertia of the gripper fingers – DHRS-25Opening and closing times  $t$  to be set at 0.6 MPa (6 bar, 87 psi) as a function of mass moment of inertia of the gripper fingers – DHRS-32Opening and closing times  $t$  to be set at 0.6 MPa (6 bar, 87 psi) as a function of mass moment of inertia of the gripper fingers – DHRS-40

## Dimensions

### Dimensions – Radial gripper DHRS

Download CAD data → [www.festo.com](http://www.festo.com)

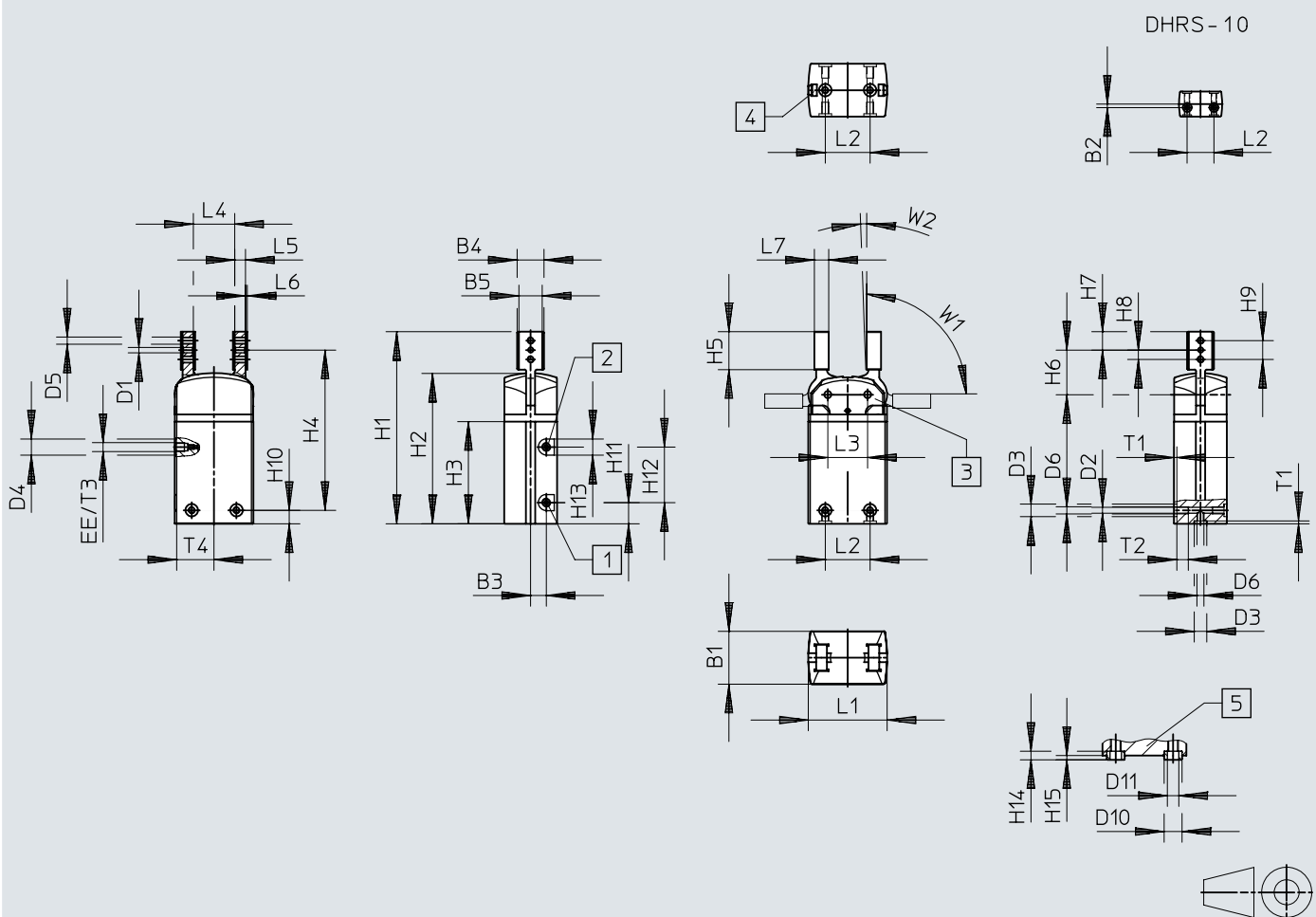

- [1] Open compressed air supply port
- [2] Close compressed air supply port
- [3] View shown without cover
- [4] Slot for proximity switch
- [5] Mounting interface: centring sleeves ZBH for mounting the gripper (2 pieces included in the scope of delivery)



## Dimensions

	B1 ±0,05	B2 <sup>1)</sup>	B3	B4	B5 +0,03/ +0,01	D1 ∅ H8	D2 ∅ +0,1	D3 ∅ H8/h7	D4 ∅	D5	D6
DHRS-10	14	2	2	8,5	6,5	2	2,4	5	7	M2,5	M3
DHRS-16	19	–	5,8	14	10	2	2,5	5	–	M3	M3
DHRS-25	29,5	–	8,75	15	13	3	3,3	7	9	M4	M4
DHRS-32	38	–	11	16	14	4	5,1	9	15	M5	M6
DHRS-40	49	–	11	24	20	5	6,4	12	15	M6	M8

	D10 ∅ h7	D11 ∅	EE	H1	H2	H3	H4 ±0,25	H5 ±0,2	H6 ±0,05	H7 –0,1
DHRS-10	5	3,2	M3	60,8	46	30,8	42,25	13,8	14,95	6,25
DHRS-16	5	3,2	M3	88,2	70,5	49	73,7	16,5	19,7	7
DHRS-25	7	5,3	M5	107,2	84	57	89,45	21,2	24,95	10,25
DHRS-32	9	6,4	G1/8	128,5	96,2	65	103,5	29,5	32	14
DHRS-40	12	10,3	G1/8	140	108,4	71,5	108,7	29,5	33,7	13,8

	H8	H9	H10 <sup>2)</sup>	H11	H12	H13	H14 –0,2	H15 –0,3	L1 ±0,05	L2 <sup>1)</sup>	L3 ±0,02
DHRS-10	4	8	12,3	8,8	16	7	2,4	1,2	24	15	12,4
DHRS-16	4	8	7,5	12,25	23	7	2,4	1,2	33,4	16	17
DHRS-25	5,25	10,5	7,5	11,8	31	9	3	1,4	44	25	22,2
DHRS-32	7	14	11	20	25	15	4	1,9	51	29	25,8
DHRS-40	8	16	17,5	9	46	15	5	2,4	59	33	30

	L4	L5 ±0,05	L6	L7	T1 +0,1	T2 +1	T3 +0,5	T4	W1 ±2°	W2 +3°
DHRS-10	12	4	0,5	5	1,2	durch	3,5	11,6	90	2
DHRS-16	21	4	1	6	1,2	5,8	4,5	16	90	2
DHRS-25	23,2	6	1	8	1,6	6,4	4,5	21	90	2
DHRS-32	24,8	8	1	10	2,1	12,9	6,5	24	90	2
DHRS-40	29,6	10	1	12	2,6	13,4	6	28,4	90	2

1) Tolerance for centring hole ±0.02 mm Tolerance for thread ±0.1 mm

2) Tolerance for centring hole –0.05 mm/tolerance for thread ±0.1 mm

Ordering data

Double-acting, without compression spring					
	Size	Max. opening angle	Product weight	Part no.	Type
	10	180 deg	44 g	1310159	DHRS-10-A
	16		114 g	1310160	DHRS-16-A
	25		270 g	1310162	DHRS-25-A
	32		480 g	1310164	DHRS-32-A
	40		829 g	1310166	DHRS-40-A

Single-acting or with gripping force backup, closing					
	Size	Max. opening angle	Product weight	Part no.	Type
	16	180 deg	118 g	1310161	DHRS-16-A-NC
	25		277 g	1310163	DHRS-25-A-NC
	32		490 g	1310165	DHRS-32-A-NC
	40		844 g	1310167	DHRS-40-A-NC

## Peripherals

## DHRS-10

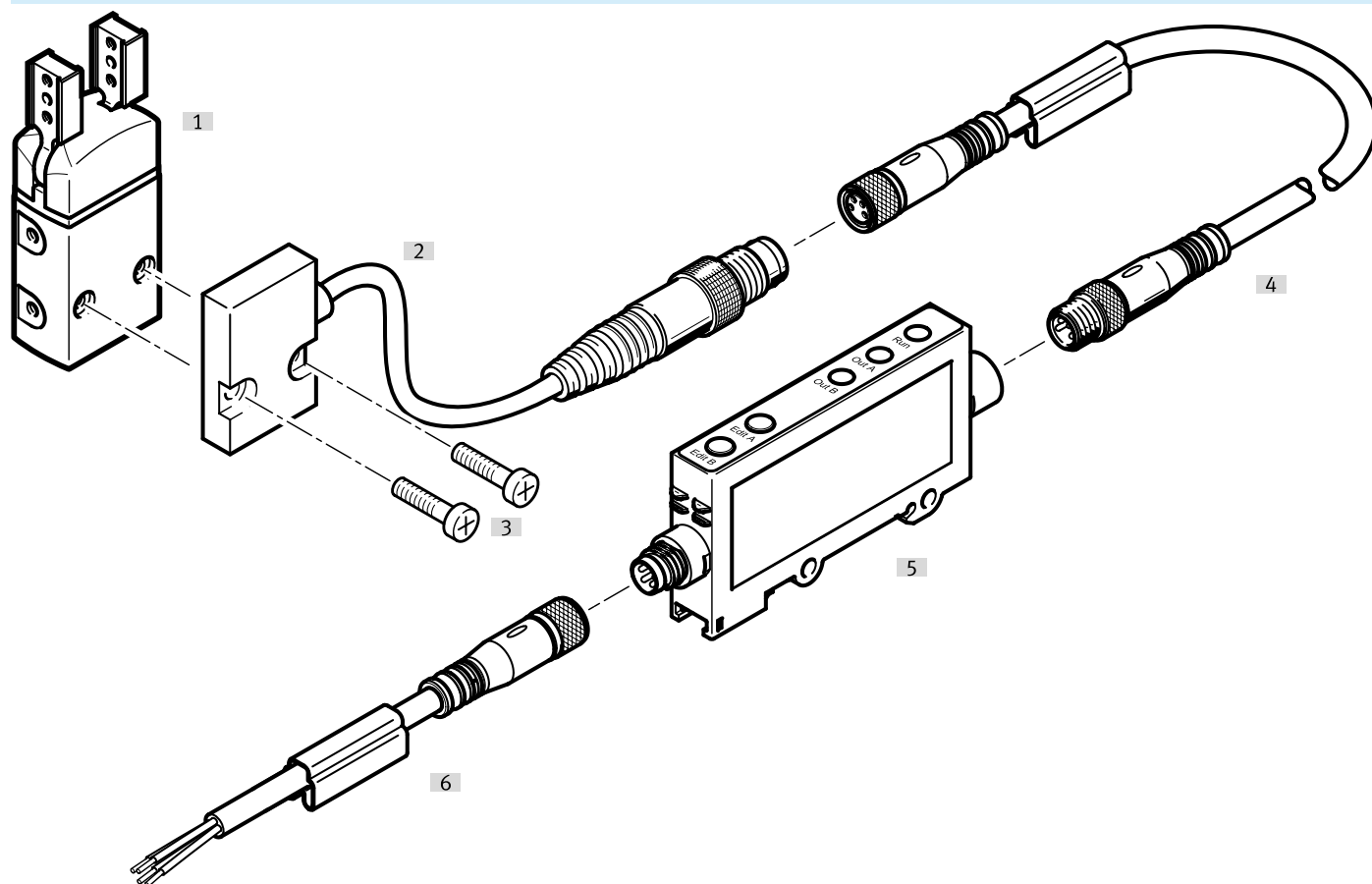

Accessories			→ Link
Type/order code	Description		
[1] Radial gripper DHRS	Double-acting		dhrs
[2] Position sensor SMH-S1	Adaptable and integrable sensors for detecting the piston position		22
[3] Screws	For mounting the SMH-S1 position sensor on the gripper		dhrs
[4] Connecting cable NEBU	Connection between position sensor and signal converter		24
[5] Signal converter SVE4	For evaluating signals for position sensor SMH-S1		22
[6] Connecting cable NEBU	Connection between signal converter and controller		24
[7] Adapter kit DHAA, HMSV, HMVA, HAPG	Connecting plate between drive and gripper		adapter
[8] Proportional-pressure regulator VPPM	For stepless adjustment of the gripping force		vppm

Peripherals

DHRS-16 ... 40

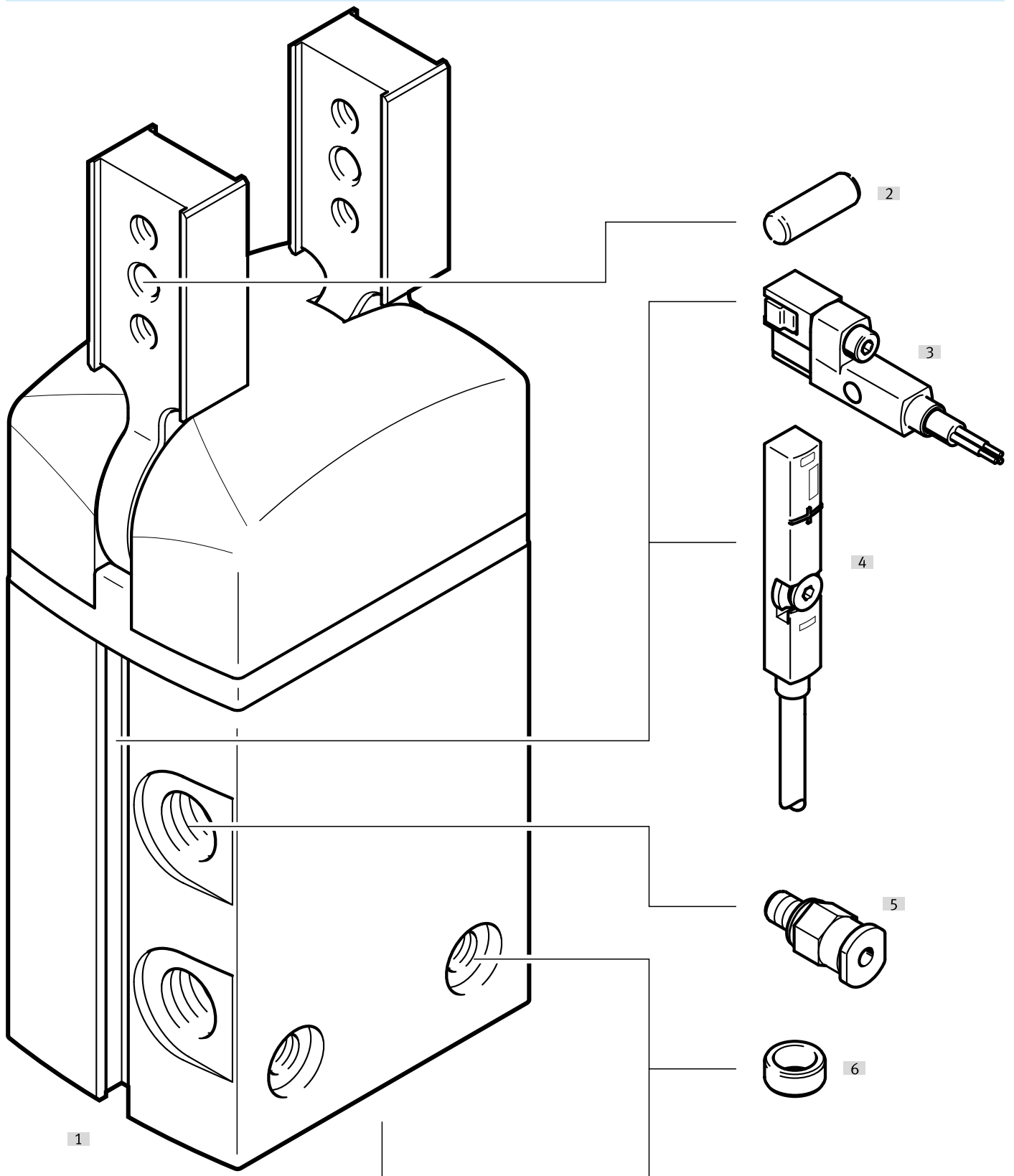



Accessories			→ Link
Type/order code	Description		
[1] Radial gripper DHRS	Double-acting		dhrs
[2] Centring pin	For centring the gripper fingers on the gripper jaws		dhrs

## Peripherals

Accessories		→ Link
Type/order code	Description	
[3] Proximity switch SMT	<ul style="list-style-type: none"> <li>• For sensing the piston position</li> <li>• Proximity switch does not project past the housing at the bottom</li> </ul>	23
[4] Position transmitter SMAT/SDAT	Continuously detects the position of the piston. It has an analogue output with an output signal that is proportional to the piston position.	24
[5] Push-in fitting QS	For connecting tubing with standard O.D	qs
[6] Centring sleeve ZBH	<ul style="list-style-type: none"> <li>• For centring the gripper when mounting</li> <li>• 2 centring sleeves included in the scope of delivery of the gripper</li> </ul>	22
[7] Adapter kit DHAA, HMSV, HMVA, HAPG	Connecting plate between drive and gripper	adapter
[8] Proportional-pressure regulator VPPM	For stepless adjustment of the gripping force	vppm

## Accessories

Centring sleeve ZBH-5						
	Description	Material sleeve	Size of pack	Product weight	Part no.	Type
	For sizes 10, 16	Steel	10	1 g	<b>8146543</b>	<b>ZBH-5-B</b>

Centring sleeve ZBH-7						
	Description	Material sleeve	Size of pack	Product weight	Part no.	Type
	For size 25	Steel	10	1 g	<b>8146544</b>	<b>ZBH-7-B</b>

Centring sleeve ZBH-9						
	Description	Material sleeve	Size of pack	Product weight	Part no.	Type
	For size 32	Steel	10	2 g	<b>8137184</b>	<b>ZBH-9-B</b>

Centring sleeve ZBH-12						
	Description	Material sleeve	Size of pack	Product weight	Part no.	Type
	For size 40	Steel	10	1 g	<b>8137185</b>	<b>ZBH-12-B</b>

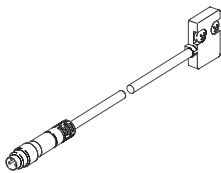
Position sensor SMH-S1 – for size 10						
	Type of mounting	Output signal	Electrical connection	Cable length	Part no.	Type
	Screwed to gripper	Analogue	Plug M8, A-coded	0.5 m	<b>175712</b>	<b>SMH-S1-HGR10</b>

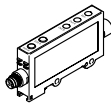
Signal converter SVE4 – for size 10						
	analog input	Electrical connection (signal input)	Electrical connection (switching output)	Switching output	Part no.	Type
	Adapted for position sensors SMH-S1-HG	Socket M8x1, 4-pin	Plug M8x1, 4-pin	2xNPN	<b>544219</b>	<b>SVE4-HS-R-HM8-2N-M8</b>
				2xPNP	<b>544216</b>	<b>SVE4-HS-R-HM8-2P-M8</b>

Connecting cables NEBU, straight – Connection between position sensor and signal converter						
	Electrical connection 1, connector system	Electrical connection 2, connector system	Electrical connection 2, number of connections/cores	Cable length	Part no.	Type
	M8x1, A-coded, to EN 61076-2-104	M8x1, A-coded to EN 61076-2-104	4	2.5 m	<b>554035</b>	<b>NEBU-M8G4-K-2.5-M8G4</b>

## Accessories

## Connecting cables NEBU, straight – Connection between signal converter and controller

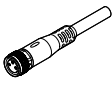
	Electrical connection 1, connector system	Electrical connection 2, connector system	Electrical connection 2, number of connections/ cores	Cable length	Part no.	Type
	M8x1, A-coded, to EN 61076-2-104	Open end	4	2.5 m	541342	NEBU-M8G4-K-2.5-LE4
				5 m	541343	NEBU-M8G4-K-5-LE4

## Connecting cables NEBU, angled – connection between signal converter and controller

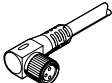
	Electrical connection 1, connector system	Electrical connection 2, connector system	Electrical connection 2, number of connections/ cores	Cable length	Part no.	Type
	M8x1, A-coded, to EN 61076-2-104	Open end	4	2.5 m	541344	NEBU-M8W4-K-2.5-LE4
				5 m	541345	NEBU-M8W4-K-5-LE4

## Proximity switch SMT-8G for T-slot, magneto-resistive – for sizes 10 ... 32

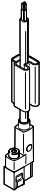
	Type of mounting	Switching output	Electrical connection	Cable length	Part no.	Type
	Clamped in T-slot, Insertable in the slot lengthwise	3-wire NPN N/O contact	Open end	2.5 m	8065028	SMT-8G-NS-24V-E-2,5Q-OE
			Plug M8, A-coded	0.3 m	8065027	SMT-8G-NS-24V-E-0,3Q-M8D
		3-wire PNP N/O contact	Open end	2.5 m	547859	SMT-8G-PS-24V-E-2,5Q-OE
			Plug M8, A-coded	0.3 m	547860	SMT-8G-PS-24V-E-0,3Q-M8D

## Connecting cable NEBU, straight, connection M8

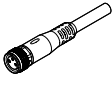
	Electrical connection 1, connector system	Electrical connection 2, connector system	Electrical connection 2, number of connections/ cores	Cable length	Part no.	Type
	M8x1, A-coded, to EN 61076-2-104	Open end	3	2.5 m	541333	NEBU-M8G3-K-2.5-LE3
				5 m	541334	NEBU-M8G3-K-5-LE3

## Connecting cable NEBU, angled, connection M8

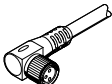
	Electrical connection 1, connector system	Electrical connection 2, connector system	Electrical connection 2, number of connections/ cores	Cable length	Part no.	Type
	M8x1, A-coded, to EN 61076-2-104	Open end	3	2.5 m	541338	NEBU-M8W3-K-2.5-LE3
				5 m	541341	NEBU-M8W3-K-5-LE3

## Accessories

## Position transmitter SMAT-8M for T-slot, plug M8, A-coded – For size 16 ... 40

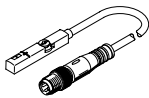
	Sensing range	Analogue output	Electrical connection 1, number of connections/ cores	Cable length	Part no.	Type
	52 mm	0 - 10 V	4	0.3 m	553744	SMAT-8M-U-E-0,3-M8D

## Position transmitter SDAT for T-slot, M8 plug, A-coded – For size 32 ... 40

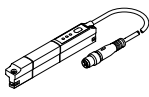
	Sensing range	Analogue output	Electrical connection 1, number of connections/ cores	Cable length	Part no.	Type
	0 ... 50.000 mm	4 - 20 mA	4	0.3 m	1531265	SDAT-MHS-M50-1L-SA-E-0.3-M8

## Connecting cables NEBU, straight

	Electrical connection 1, connector system	Electrical connection 2, connector system	Electrical connection 2, number of connections/ cores	Cable length	Part no.	Type
	M8x1, A-coded, to EN 61076-2-104	Open end	4	2.5 m	541342	NEBU-M8G4-K-2.5-LE4
				5 m	541343	NEBU-M8G4-K-5-LE4

## Connecting cables NEBU, angled

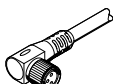
	Electrical connection 1, connector system	Electrical connection 2, connector system	Electrical connection 2, number of connections/ cores	Cable length	Part no.	Type
	M8x1, A-coded, to EN 61076-2-104	Open end	4	2.5 m	541344	NEBU-M8W4-K-2.5-LE4
				5 m	541345	NEBU-M8W4-K-5-LE4