

Twin cylinders DPZ/DPZJ

FESTO



Key features

High force with excellent protection against rotation

- Twice the force in half the space
- 100 to 1,000 N thrust at 6 bar operating pressure
- Load-bearing capacity (F_q) from 8 to 105 N
- Permissible torque resistance (M_L), with an impact centrically from 0.1 to 3 Nm
- Widely spaced piston rods for high load capacity

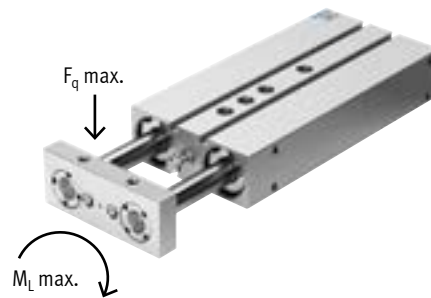

Precision stroke adjustment

- Standard bolt with lock nut enables adjustment of the standard strokes within a range of 10 mm
- Longer screws may be used if required

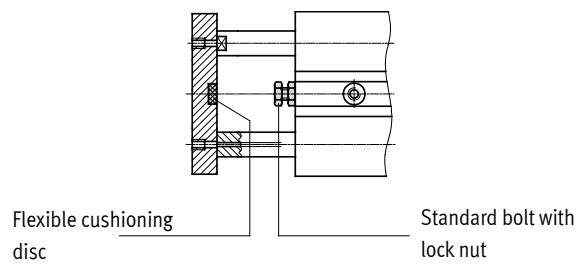

Grid dimension

- 20 and 40 mm to suit profile systems

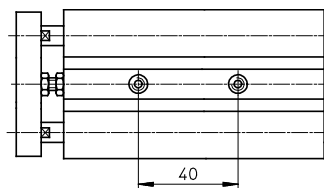

Key features

Mounting options

Horizontal mounting from above

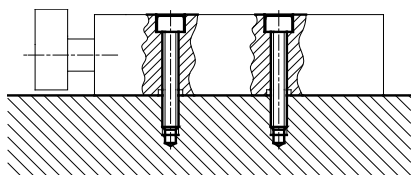

Horizontal mounting from below

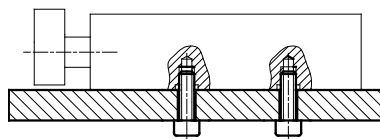

Side mounting from below

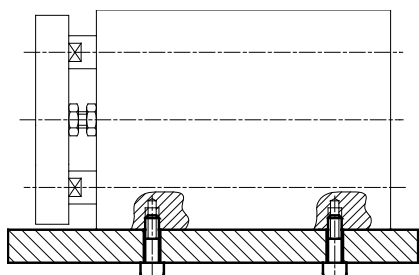

Multi-axis and drive combinations

The twin cylinder DPZ/DPZJ can be combined with different drives. An adapter kit is required for mounting between the two drives.

Adapter kits

- Internet: adapter kit
- www.festo.com

DPZ-/DPZ axis

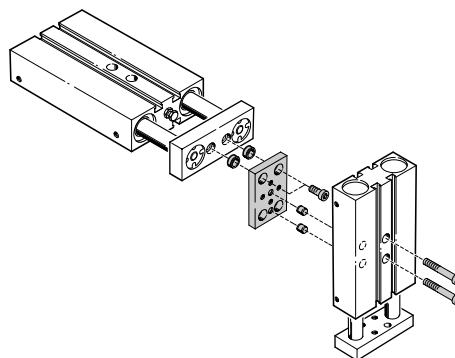

Product range overview

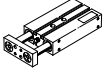
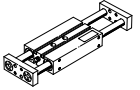
Function	Design	Type	Piston \varnothing [mm]	Stroke [mm]	Precision end-position adjustment	
					Retracted end position	Advanced end position
Double-acting	Basic version					
		DPZ	10	10, 25, 40, 50	■	-
			16, 20, 25, 32	10, 25, 40, 50, 80, 100		
	Through piston rods with additional yoke plate					
	DPZJ For higher lateral forces and precision	10	10, 25, 40, 50	■	■	
		16, 20, 25, 32	10, 25, 40, 50, 80, 100			

Product range overview

Type	Position sensing A	Plain-bearing guide GF	Recirculating ball bearing guide KF	Through piston rod S2	→ Page/Internet
Basic version					
DPZ	■	■	■	■	8
Through piston rods with additional yoke plate					
DPZJ for higher lateral forces and precision	■	■	■	■	8

Peripherals overview

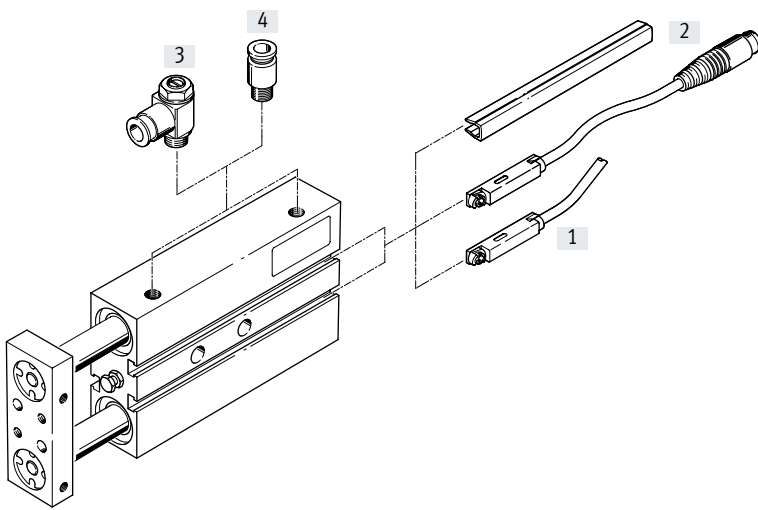

Accessories	Description	Piston ø		→ Page/Internet
		10, 16 mm	20, 25, 32 mm	
[1] Proximity switch SME/SMT-8	Can be integrated in the cylinder profile barrel	■	■	19
[2] Slot cover ABP-5-S	For protecting the sensor cables and the sensor slots from contamination	■	■	19
[3] One-way flow control valve GRLA	For regulating speed	■	■	20
[4] Push-in fitting QS	For connecting compressed air tubing with standard O.D.	■	■	qs
- Centring pin ZBS	4 included in the scope of delivery	■	-	20
- Centring sleeve ZBH	4 included in the scope of delivery	-	■	20
- Adapters	For drive/drive connections	■	■	21
	For drive/gripper connections			gripper

Type codes

001	Series
DPZ	Double piston cylinder with one end plate, double-acting
DPZJ	Double piston cylinder with through piston rod and two end plates, double-acting

002	Size
10	10
16	16
20	20
25	25
32	32

003	Stroke
...	10 ... 100

004	Cushioning
P	Elastic cushioning rings/plates on both sides

005	Position sensing
A	For proximity sensor

006	Guide
GF	Plain bearing
KF	Recirculating ball bearing guide

007	Piston rod type
	At one end
S2	Through piston rod

Data sheet

Function DPZ



- Diameter
10 ... 32 mm
- Stroke length
10 ... 100 mm

Function DPZJ

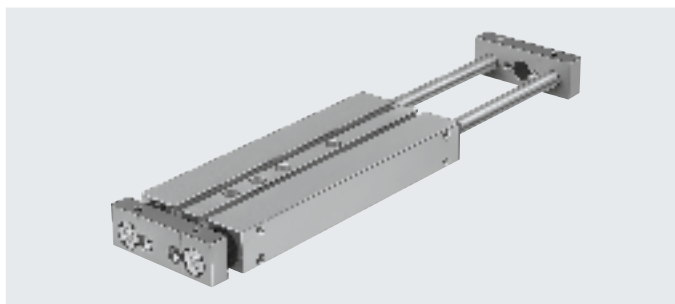
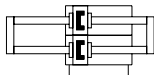

- Diameter
10 ... 32 mm
- Stroke length
10 ... 100 mm

General technical data						
Piston \varnothing		10	16	20	25	32
Pneumatic connection		M5	M5	M5	M5	G1/8
Operating medium		Compressed air to ISO 8573-1:2010 [7:4:4]				
Note on the operating/ pilot medium		Lubricated operation possible (in which case lubricated operation will always be required)				
Operating pressure						
	[MPa]	0.25 ... 1		0.1 ... 1		
	[psi]	36 ... 145		14.5 ... 145		
	[bar]	2.5 ... 10		1 ... 10		
Design		Parallel piston rods Parallel piston rods with yoke				
Cushioning		Elastic end-position cushioning				
Position sensing		Via proximity switch				
Type of mounting		Via through-hole With female thread With mounting plate				
Mounting position		Any				
Protection against rotation/guide		Parallel pistons / plain-bearing or recirculating ball bearing guide				
Environmental conditions						
Variant		Plain-bearing guide GF			Recirculating ball bearing guide KF	
Ambient temperature ¹⁾	[°C]	-20 ... +80				
Corrosion resistance class CRC ²⁾		2			-	

1) Note operating range of proximity switches

2) Corrosion resistance class CRC 2 to Festo standard FN 940070

Moderate corrosion stress. Indoor applications in which condensation can occur. External visible parts with primarily decorative surface requirements which are in direct contact with a normal industrial environment.

Data sheet

Forces [N] and impact energy [J]		10	16	20	25	32
Piston \varnothing		10	16	20	25	32
Theoretical force at 0.6 MPa (6 bar, 87 psi), advancing	S2, DPZ	94	242	376	590	966
Theoretical force at 0.6 MPa (6 bar, 87 psi), retracting	S2, DPZ	60	180	282	452	724
Max. impact energy at the end positions		0.08	0.15	0.2	0.3	0.5

Permissible lateral force F_q as a function of stroke l

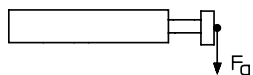

Piston rod at one end

Plain-bearing guide GF

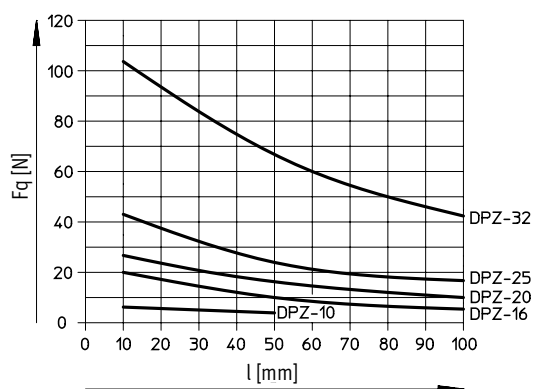

Recirculating ball bearing guide KF

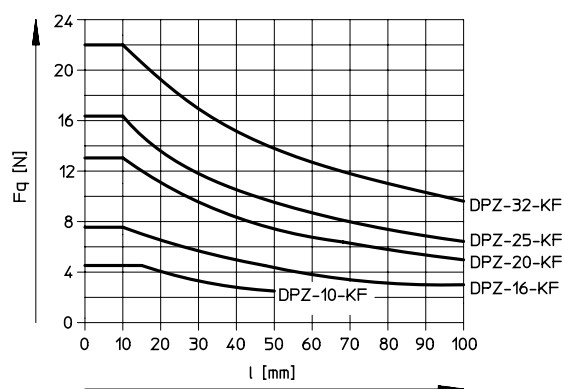

Through piston rod

Plain-bearing guide GF

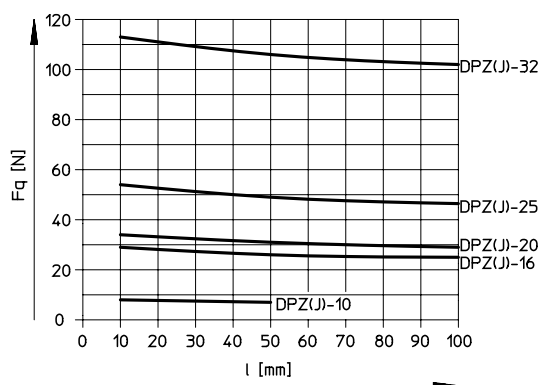

Recirculating ball bearing guide KF

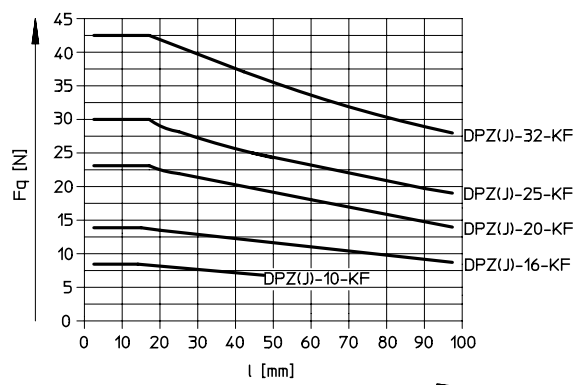

Data sheet

Permissible torque M as a function of stroke l

Piston rod at one end

Plain-bearing guide GF

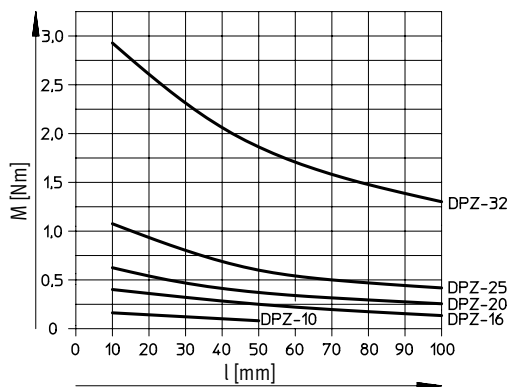

Recirculating ball bearing guide KF

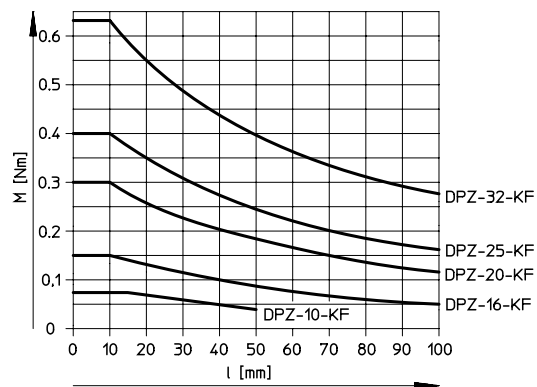

Through piston rod

Plain-bearing guide GF

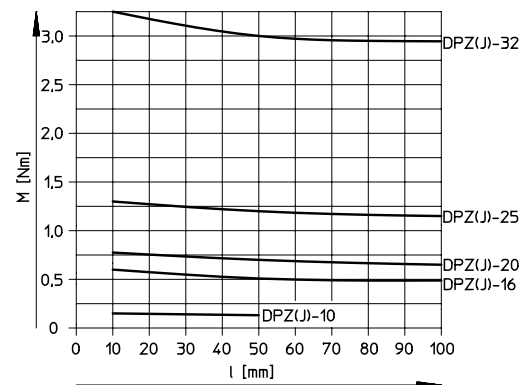

Recirculating ball bearing guide KF

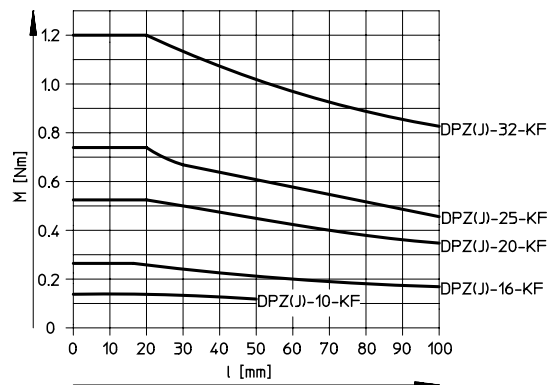

Data sheet

DPZ with plain-bearing guide GF					
Stroke [mm]	Piston \varnothing [mm]				
	10	16	20	25	32
Product weight [g]					
0	234	389	568	838	1389
10	257	416	607	891	1473
25	291	456	666	971	1598
40	325	496	725	1052	1723
50	348	523	764	1105	1806
80	417	603	882	1265	2057
100	463	657	960	1372	2223

DPZ with recirculating ball bearing guide KF					
Stroke [mm]	Piston \varnothing [mm]				
	10	16	20	25	32
Product weight [g]					
0	243	368	522	742	1200
10	266	395	561	795	1283
25	300	435	620	875	1408
40	334	475	679	955	1533
50	357	502	718	1009	1617
80	426	582	836	1169	1867
100	472	636	914	1276	2034

Materials

Sectional view

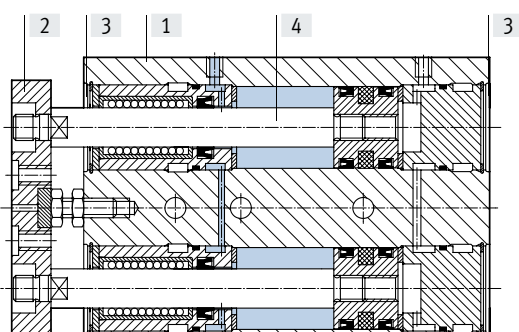

Twin cylinder		
[1]	Housing	Wrought aluminium alloy
[2]	Yoke plate	Tempered steel
[3]	Cover	Wrought aluminium alloy
[4]	Piston rod	GF High-alloy stainless steel
		KF Tempered steel
-	Seals	Polyurethane, nitrile rubber

Data sheet

Dimensions – Basic cylinders

Download CAD data → www.festo.com

Piston \varnothing 10, 16 mm

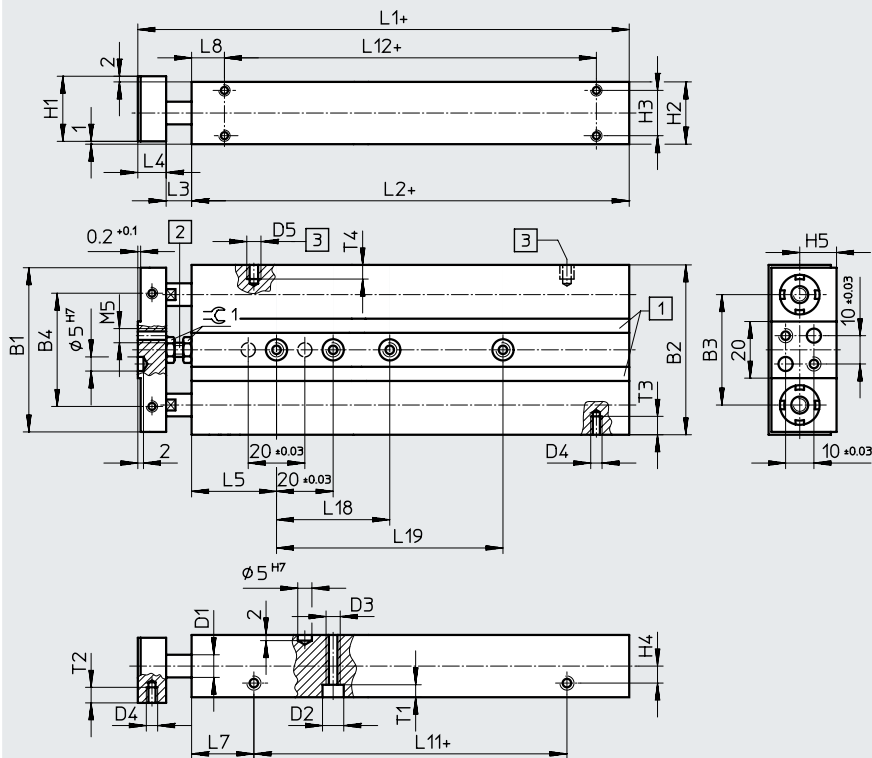

- [1] Mounting slot for proximity switch
- [2] Stop screw for stroke adjustment (max. 10 mm)
- [3] Supply port
- + = plus stroke length

\varnothing [mm]	B1	B2	B3	B4	D1 \varnothing	D2 \varnothing	D3 \varnothing	D4	D5	H1	H2	H3	H4	H5	L1		L2	
															GF	KF	GF	KF
10	48	50	33	28	6	7.5	M5	M4	M5	20	19	13	4.5	11.5	89.6	100	71.6	82
16	58	60	39	40	8	7.5	M5	M4	M5	23	22	16	6	13	93.6	107	74.6	88

\varnothing [mm]	L3	L4	L5	L7		L8		L11		L12 ± 0.2		T1	T2	T3	T4	$\approx \varnothing 1$
				GF	KF	GF	KF	GF	KF	GF	KF					
10	8	10	30	23.4	40.7	13.1	30.8	24.8	24.4	45.4	44.2	4.4	6	5	5	7
16	9	10	30	22	38.9	11.6	25.5	30.6	30.6	51.4	54.4	4.4	5.5	6.5	5	8

Stroke [mm]	L18 ± 0.03		L19 ± 0.03	
	10	-	-	-
25	-	-	-	-
40	40	-	-	-
50	40	-	-	-
80	40	-	80	-
100	40	-	80	-

Data sheet

Dimensions – Basic cylinders

Download CAD data → www.festo.com

Piston \varnothing 20, 25, 32 mm

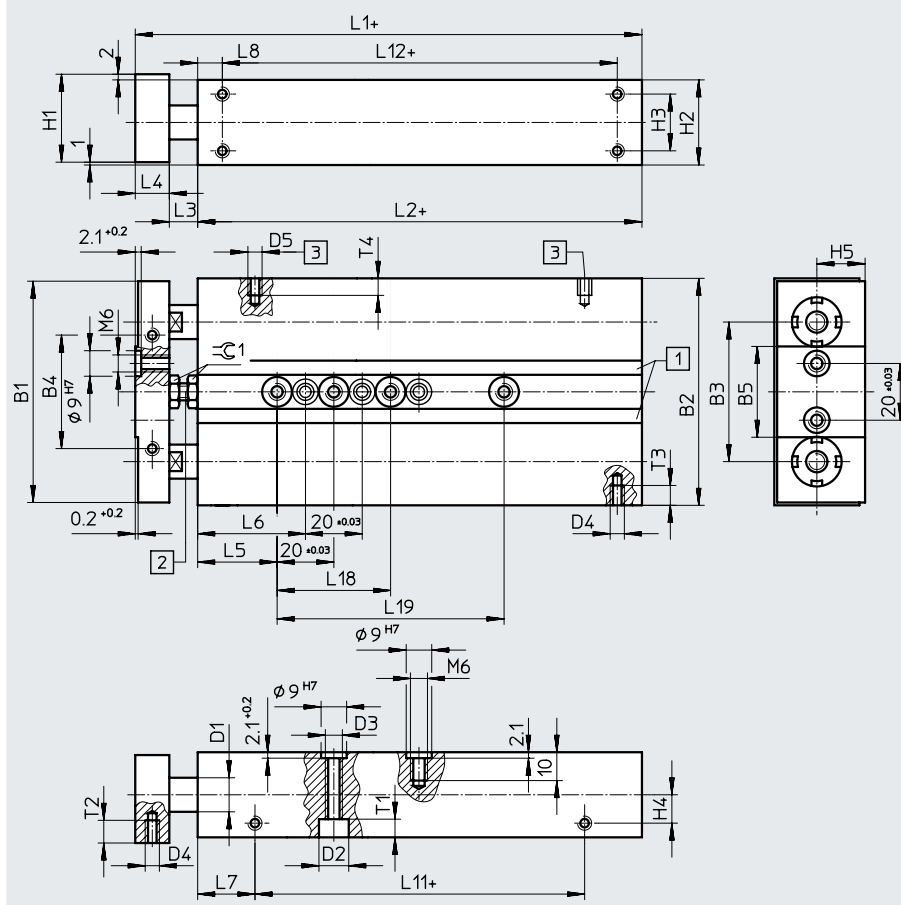

- [1] Mounting slot for proximity switch
- [2] Stop screw for stroke adjustment (max. 10 mm)
- [3] Supply port
- + = plus stroke length

\varnothing [mm]	B1	B2	B3	B4	B5	D1 \varnothing	D2 \varnothing	D3 \varnothing	D4	D5	H1	H2	H3	H4	H5	L1		L2	
																GF	KF	GF	KF
20	70	72	45.6	40	32	10	9	M6	M5	M5	25	24	16	7	14	98.6	115	76.6	93
25	78	80	49.2	40	32	12	10.5	6.4	M5	M5	31	30	20	10	17	98.6	116	76.6	94
32	96	98	57	40	35	16	10.5	6.4	M6	G1/8	39	38	26	11.5	21	110.1	130	80.1	100

\varnothing [mm]	L3	L4	L5	L6	L7		L8		L11		L12 ± 0.2		T1	T2	T3	T4	$\approx \text{C1}$
					GF	KF	GF	KF	GF	KF	GF	KF					
20	10	12	30	-	22.8	43.4	12.9	33.5	31	30.7	50.8	50.5	5.7	6.5	7	6	10
25	10	12	28	38	20.2	40	8.7	28.8	36.2	33.8	59.2	56.5	6.4	8	7	6	10
32	15	15	35	45	25	44.9	10	26	30.1	30.1	60.1	64	6.4	8	9	9	10

Stroke [mm]	L18 ± 0.03				L19 ± 0.03			
10								
25								
40								
50					40			
80					40			80
100					40			80

Data sheet

Dimensions – Variants DPZ

Download CAD data → www.festo.com

S2 – Through piston rod

∅ 10, 16

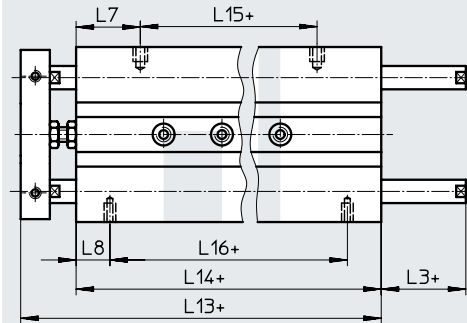

∅ 20, 25, 32

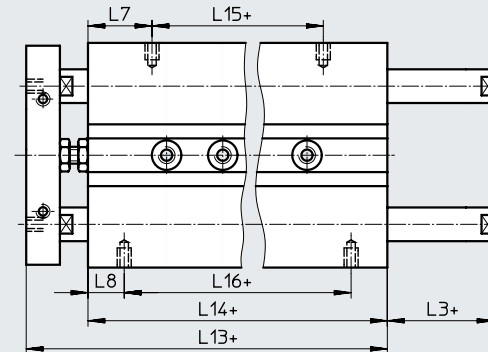

+ = plus stroke length

∅ [mm]	L3	L7		L8		L13		L14		L15		L16 ±0.2	
		GF	KF	GF	KF	GF	KF	GF	KF	GF	KF	GF	KF
10	8	23.4	40.7	13.1	30.8	89.6	124	71.6	106	24.8	24.7	45.4	44.4
16	9	22	38.9	11.6	25.5	93.6	127.4	74.6	108.4	30.6	30.6	51.4	57.4
20	10	22.8	43.4	12.9	33.5	98.6	139.2	76.6	117.2	31	30.4	50.8	50.2
25	10	20.2	40	8.7	28.8	98.6	135	76.6	113	36.2	33	59.2	55.4
32	15	25	44.9	10	26	110.1	149.9	80.1	119.9	30.1	30.1	60.1	67.9

Data sheet

Dimensions – Variants DPZJ

Download CAD data → www.festo.com

S2 – Through piston rod

∅ 10, 16

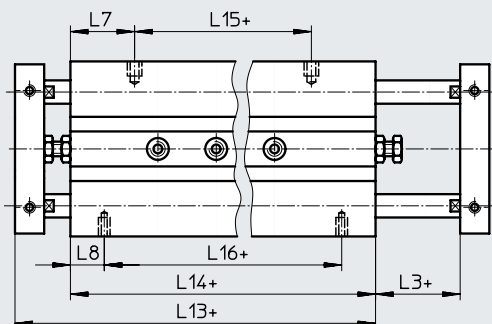

∅ 20, 25, 32

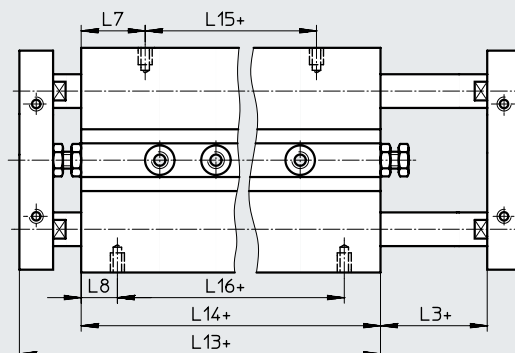

+ = plus stroke length

∅ [mm]	L3	L7		L8		L13		L14		L15		L16 ±0.2	
		GF	KF	GF	KF	GF	KF	GF	KF	GF	KF	GF	KF
10	8	23.4	40.7	13.1	30.8	89.6	124	71.6	106	24.8	24.7	45.4	44.4
16	9	22	38.9	11.6	25.5	93.6	127.4	74.6	108.4	30.6	30.6	51.4	57.4
20	10	22.8	43.4	12.9	33.5	98.6	139.2	76.6	117.2	31	30.4	50.8	50.2
25	10	20.2	40	8.7	28.8	98.6	135	76.6	113	36.2	33	59.2	55.4
32	15	25	44.9	10	26	110.1	149.9	80.1	119.9	30.1	30.1	60.1	67.9

Data sheet

Ordering data – Basic version DPZ						
Piston ø [mm]	Stroke [mm]	Plain-bearing guide GF		Recirculating ball bearing guide KF		
		Part no.	Type ¹⁾	Part no.	Type ¹⁾	
10	10	32681	DPZ-10-10-P-A	162001	DPZ-10-10-P-A-KF	
	25	32682	DPZ-10-25-P-A	162002	DPZ-10-25-P-A-KF	
	40	32683	DPZ-10-40-P-A	162003	DPZ-10-40-P-A-KF	
	50	32684	DPZ-10-50-P-A	162004	DPZ-10-50-P-A-KF	
16	10	32686	DPZ-16-10-P-A	162026	DPZ-16-10-P-A-KF	
	25	32687	DPZ-16-25-P-A	162027	DPZ-16-25-P-A-KF	
	40	32688	DPZ-16-40-P-A	162028	DPZ-16-40-P-A-KF	
	50	32689	DPZ-16-50-P-A	162029	DPZ-16-50-P-A-KF	
	80	32690	DPZ-16-80-P-A	162030	DPZ-16-80-P-A-KF	
	100	32691	DPZ-16-100-P-A	162031	DPZ-16-100-P-A-KF	
20	10	32693	DPZ-20-10-P-A	162061	DPZ-20-10-P-A-KF	
	25	32694	DPZ-20-25-P-A	162062	DPZ-20-25-P-A-KF	
	40	32695	DPZ-20-40-P-A	162063	DPZ-20-40-P-A-KF	
	50	32696	DPZ-20-50-P-A	162064	DPZ-20-50-P-A-KF	
	80	32697	DPZ-20-80-P-A	162065	DPZ-20-80-P-A-KF	
	100	32698	DPZ-20-100-P-A	162066	DPZ-20-100-P-A-KF	
25	10	32700	DPZ-25-10-P-A	162096	DPZ-25-10-P-A-KF	
	25	32701	DPZ-25-25-P-A	162097	DPZ-25-25-P-A-KF	
	40	32702	DPZ-25-40-P-A	162098	DPZ-25-40-P-A-KF	
	50	32703	DPZ-25-50-P-A	162099	DPZ-25-50-P-A-KF	
	80	32704	DPZ-25-80-P-A	162100	DPZ-25-80-P-A-KF	
	100	32705	DPZ-25-100-P-A	162101	DPZ-25-100-P-A-KF	
32	10	159817	DPZ-32-10-P-A	162131	DPZ-32-10-P-A-KF	
	25	159818	DPZ-32-25-P-A	162132	DPZ-32-25-P-A-KF	
	40	159819	DPZ-32-40-P-A	162133	DPZ-32-40-P-A-KF	
	50	159820	DPZ-32-50-P-A	162134	DPZ-32-50-P-A-KF	
	80	159821	DPZ-32-80-P-A	162135	DPZ-32-80-P-A-KF	
	100	159822	DPZ-32-100-P-A	162136	DPZ-32-100-P-A-KF	

1) 4 centring pins or sleeves are included in the scope of delivery.

Data sheet

Ordering data – Variant DPZ					
Piston Ø [mm]	Stroke [mm]	Plain-bearing guide GF		Recirculating ball bearing guide KF	
		Part no.	Type ¹⁾	Part no.	Type ¹⁾
S2 – Through piston rod					
10	10	159862	DPZ-10-10-P-A-S2	162006	DPZ-10-10-P-A-KF-S2
	25	159863	DPZ-10-25-P-A-S2	162007	DPZ-10-25-P-A-KF-S2
	40	159864	DPZ-10-40-P-A-S2	162008	DPZ-10-40-P-A-KF-S2
	50	159865	DPZ-10-50-P-A-S2	162009	DPZ-10-50-P-A-KF-S2
16	10	159867	DPZ-16-10-P-A-S2	162033	DPZ-16-10-P-A-KF-S2
	25	159868	DPZ-16-25-P-A-S2	162034	DPZ-16-25-P-A-KF-S2
	40	159869	DPZ-16-40-P-A-S2	162035	DPZ-16-40-P-A-KF-S2
	50	159870	DPZ-16-50-P-A-S2	162036	DPZ-16-50-P-A-KF-S2
	80	159871	DPZ-16-80-P-A-S2	162037	DPZ-16-80-P-A-KF-S2
	100	159872	DPZ-16-100-P-A-S2	162038	DPZ-16-100-P-A-KF-S2
20	10	159874	DPZ-20-10-P-A-S2	162068	DPZ-20-10-P-A-KF-S2
	25	159875	DPZ-20-25-P-A-S2	162069	DPZ-20-25-P-A-KF-S2
	40	159876	DPZ-20-40-P-A-S2	162070	DPZ-20-40-P-A-KF-S2
	50	159877	DPZ-20-50-P-A-S2	162071	DPZ-20-50-P-A-KF-S2
	80	159878	DPZ-20-80-P-A-S2	162072	DPZ-20-80-P-A-KF-S2
	100	159879	DPZ-20-100-P-A-S2	162073	DPZ-20-100-P-A-KF-S2
25	10	159881	DPZ-25-10-P-A-S2	162103	DPZ-25-10-P-A-KF-S2
	25	159882	DPZ-25-25-P-A-S2	162104	DPZ-25-25-P-A-KF-S2
	40	159883	DPZ-25-40-P-A-S2	162105	DPZ-25-40-P-A-KF-S2
	50	159884	DPZ-25-50-P-A-S2	162106	DPZ-25-50-P-A-KF-S2
	80	159885	DPZ-25-80-P-A-S2	162107	DPZ-25-80-P-A-KF-S2
	100	159886	DPZ-25-100-P-A-S2	162108	DPZ-25-100-P-A-KF-S2
32	10	159891	DPZ-32-10-P-A-S2	162138	DPZ-32-10-P-A-KF-S2
	25	159892	DPZ-32-25-P-A-S2	162139	DPZ-32-25-P-A-KF-S2
	40	159893	DPZ-32-40-P-A-S2	162140	DPZ-32-40-P-A-KF-S2
	50	159894	DPZ-32-50-P-A-S2	162141	DPZ-32-50-P-A-KF-S2
	80	159895	DPZ-32-80-P-A-S2	162142	DPZ-32-80-P-A-KF-S2
	100	159896	DPZ-32-100-P-A-S2	162143	DPZ-32-100-P-A-KF-S2









1) 4 centring pins or sleeves are included in the scope of delivery.

Data sheet

Ordering data – Variant DPZJ						
Piston ø [mm]	Stroke [mm]	Plain-bearing guide GF		Recirculating ball bearing guide KF		
		Part no.	Type ¹⁾	Part no.	Type ¹⁾	
S2 – Through piston rod						
10	10	159940	DPZJ-10-10-P-A-S2	162016	DPZJ-10-10-P-A-KF-S2	
	25	159941	DPZJ-10-25-P-A-S2	162017	DPZJ-10-25-P-A-KF-S2	
	40	159942	DPZJ-10-40-P-A-S2	162018	DPZJ-10-40-P-A-KF-S2	
	50	159943	DPZJ-10-50-P-A-S2	162019	DPZJ-10-50-P-A-KF-S2	
16	10	159945	DPZJ-16-10-P-A-S2	162047	DPZJ-16-10-P-A-KF-S2	
	25	159946	DPZJ-16-25-P-A-S2	162048	DPZJ-16-25-P-A-KF-S2	
	40	159947	DPZJ-16-40-P-A-S2	162049	DPZJ-16-40-P-A-KF-S2	
	50	159948	DPZJ-16-50-P-A-S2	162050	DPZJ-16-50-P-A-KF-S2	
	80	159949	DPZJ-16-80-P-A-S2	162051	DPZJ-16-80-P-A-KF-S2	
	100	159950	DPZJ-16-100-P-A-S2	162052	DPZJ-16-100-P-A-KF-S2	
20	10	159952	DPZJ-20-10-P-A-S2	162082	DPZJ-20-10-P-A-KF-S2	
	25	159953	DPZJ-20-25-P-A-S2	162083	DPZJ-20-25-P-A-KF-S2	
	40	159954	DPZJ-20-40-P-A-S2	162084	DPZJ-20-40-P-A-KF-S2	
	50	159955	DPZJ-20-50-P-A-S2	162085	DPZJ-20-50-P-A-KF-S2	
	80	159956	DPZJ-20-80-P-A-S2	162086	DPZJ-20-80-P-A-KF-S2	
	100	159957	DPZJ-20-100-P-A-S2	162087	DPZJ-20-100-P-A-KF-S2	
25	10	159959	DPZJ-25-10-P-A-S2	162117	DPZJ-25-10-P-A-KF-S2	
	25	159960	DPZJ-25-25-P-A-S2	162118	DPZJ-25-25-P-A-KF-S2	
	40	159961	DPZJ-25-40-P-A-S2	162119	DPZJ-25-40-P-A-KF-S2	
	50	159962	DPZJ-25-50-P-A-S2	162120	DPZJ-25-50-P-A-KF-S2	
	80	159963	DPZJ-25-80-P-A-S2	162121	DPZJ-25-80-P-A-KF-S2	
	100	159964	DPZJ-25-100-P-A-S2	162122	DPZJ-25-100-P-A-KF-S2	
32	10	159969	DPZJ-32-10-P-A-S2	162152	DPZJ-32-10-P-A-KF-S2	
	25	159970	DPZJ-32-25-P-A-S2	162153	DPZJ-32-25-P-A-KF-S2	
	40	159971	DPZJ-32-40-P-A-S2	162154	DPZJ-32-40-P-A-KF-S2	
	50	159972	DPZJ-32-50-P-A-S2	162155	DPZJ-32-50-P-A-KF-S2	
	80	159973	DPZJ-32-80-P-A-S2	162156	DPZJ-32-80-P-A-KF-S2	
	100	159974	DPZJ-32-100-P-A-S2	162157	DPZJ-32-100-P-A-KF-S2	



1) 4 centring pins or sleeves are included in the scope of delivery

Accessories

Ordering data – Proximity switch for T-slot, magneto-resistive						Data sheets → Internet: smt
	Type of mounting	Switching output	Electrical connection	Cable length [m]	Part no.	Type
N/O						
	Inserted in the slot from above, flush with the cylinder profile, short design	PNP	Cable, 3-wire	2.5	574335	SMT-8M-A-PS-24V-E-2.5-OE
			Plug M8x1, 3-pin	0.3	574334	SMT-8M-A-PS-24V-E-0.3-M8D
			Plug M12x1, 3-pin	0.3	574337	SMT-8M-A-PS-24V-E-0.3-M12
		NPN	Cable, 3-wire	2.5	574338	SMT-8M-A-NS-24V-E-2.5-OE
			Plug M8x1, 3-pin	0.3	574339	SMT-8M-A-NS-24V-E-0.3-M8D
N/C						
	Inserted in the slot from above, flush with the cylinder profile, short design	PNP	Cable, 3-wire	7.5	574340	SMT-8M-A-PO-24V-E-7.5-OE
Ordering data – Proximity switches for T-slot, magnetic reed						Data sheets → Internet: sme
	Type of mounting	Switching output	Electrical connection	Cable length [m]	Part no.	Type
N/O						
	Inserted in the slot from above, flush with the cylinder profile	Contacting	Cable, 3-wire	2.5	543862	SME-8M-DS-24V-K-2.5-OE
			5.0	543863	SME-8M-DS-24V-K-5.0-OE	
			Cable, 2-wire	2.5	543872	SME-8M-ZS-24V-K-2.5-OE
			Plug M8x1, 3-pin	0.3	543861	SME-8M-DS-24V-K-0.3-M8D
	Inserted in the slot lengthwise, flush with the cylinder profile	Contacting	Cable, 3-wire	2.5	150855	SME-8-K-LED-24
			Plug M8x1, 3-pin	0.3	150857	SME-8-S-LED-24
N/C						
	Inserted in the slot lengthwise, flush with the cylinder profile	Contacting	Cable, 3-wire	7.5	160251	SME-8-O-K-LED-24
Ordering data – Connecting cables						Data sheets → Internet: nebu
	Electrical connection, left	Electrical connection, right	Cable length [m]	Part no.	Type	
	Straight socket, M8x1, 3-pin	Cable, open end, 3-wire	2.5	541333	NEBU-M8G3-K-2.5-LE3	
			5	541334	NEBU-M8G3-K-5-LE3	
	Straight socket, M12x1, 5-pin	Cable, open end, 3-wire	2.5	541363	NEBU-M12G5-K-2.5-LE3	
			5	541364	NEBU-M12G5-K-5-LE3	
	Angled socket, M8x1, 3-pin	Cable, open end, 3-wire	2.5	541338	NEBU-M8W3-K-2.5-LE3	
			5	541341	NEBU-M8W3-K-5-LE3	
	Angled socket, M12x1, 5-pin	Cable, open end, 3-wire	2.5	541367	NEBU-M12W5-K-2.5-LE3	
			5	541370	NEBU-M12W5-K-5-LE3	
Ordering data – Slot cover for T-slot						
	Mounting	Length	Part no.	Type		
	Insertable	2x 0.5 m	151680	ABP-5-S		

Data sheet

Ordering data – One-way flow control valves				Data sheets → Internet: grla	
	Connection	For tubing O.D.	Material	Part no.	Type
	Thread				
	M5	3	Metal design	193137	GRLA-M5-QS-3-D
		4		193138	GRLA-M5-QS-4-D
		6		193139	GRLA-M5-QS-6-D
	G1/8	3		193142	GRLA-1/8-QS-3-D
		4		193143	GRLA-1/8-QS-4-D
		6		193144	GRLA-1/8-QS-6-D
		8		193145	GRLA-1/8-QS-8-D

Ordering data – Accessories					
	For ø	Material	Part no.	Type	PU ¹⁾
	[mm]				
Centring pin ZBS					
	10 ... 20	Stainless steel Free of copper and PTFE	150928	ZBS-5	10
Centring sleeve ZBH					
	25 ... 50	Stainless steel Free of copper and PTFE	8137184	ZBH-9-B	10

1) Packaging unit

Accessories

Adapter kit
BPL

Material:
Wrought aluminium alloy
Free of copper and PTFE
RoHS-compliant

 **Note**

The kit includes the individual mounting interface as well as the necessary mounting material.

Permissible drive/drive combinations with adapter kit

Download CAD data → www.festo.com

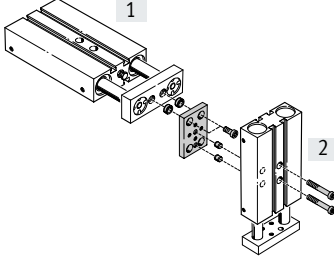
Combination	[1] Drive	[2] Drive	Adapter kit	Part no.	Type
	Size	Size			
DPZ/DPZ	DPZ	DPZ	BPL		
	20, 25, 32	10, 16	2	150929	BPL-1
	20, 25, 32	20		150930	BPL-2
	25, 32	25		150931	BPL-3
	32	32		150931	BPL-3

1) Corrosion resistance class CRC 2 to Festo standard FN 940070

Moderate corrosion stress. Indoor applications in which condensation can occur. External visible parts with primarily decorative surface requirements which are in direct contact with a normal industrial environment.