

Mini slide EGSL, electric

FESTO



Characteristics

At a glance

- Electric slide series
- Maximum performance in a compact space:
 - Precision
 - Load capacity
 - Dynamic response
- Choice of homing:
 - To fixed stop
 - To reference switch
- Ideal for vertical applications
- System product for handling and assembly technology
- Wide range of options for mounting on drives

Motor attachment variants

Axial

Parallel



Characteristic values of the axes

The specifications shown in the table are maximum values. The precise values for each of the variants can be found in the relevant data sheet.

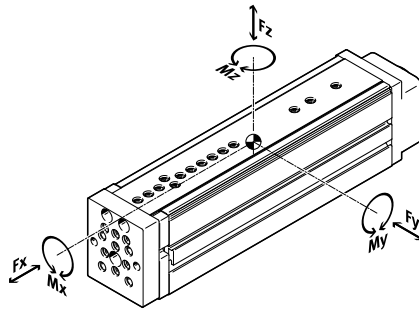

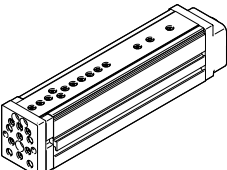
Version	Size	Working stroke [mm]	Speed [m/s]	Max. acceleration [m/s ²]	Repetition accuracy [mm]	Feed force F _x [N]	Guide characteristics				
							Forces and torques				
							F _y [N]	F _z [N]	M _x [Nm]	M _y [Nm]	M _z [Nm]
	35	50	0.5	25	±0.015	75	512	512	6.2	6.0	6.0
	45	100, 200	1.0	25	±0.015	150	631	631	18.6	16.3	16.3
	55	100, 200, 250	1.0	25	±0.015	300	1047	1047	33.1	33.3	33.3
	75	100, 200, 300	1.3	25	±0.015	450	1539	1539	67.4	47.1	47.1

Note

Engineering software
Electric Motion Sizing
www.festo.com/x/electric-motion-sizing

Characteristics

Complete system comprising mini slide, motor, motor controller and motor mounting kit

Mini slide

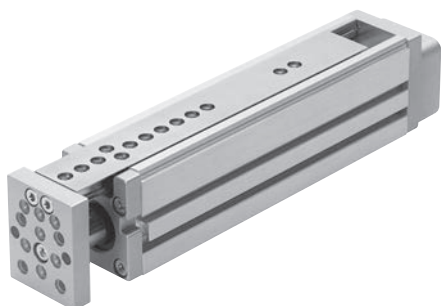

Motor

→ Page 22



Servo motor:
EMMT-AS, EMME-AS
Stepper motor:
EMMS-ST



Note

A range of specially coordinated complete solutions is available for the mini slide EGSL and the motors.

Servo drive



Servo drive:
CMMT-AS
Servo drive for extra-low voltage:
CMMT-ST

Motor mounting kit

→ Page 22

Axial kit

Parallel kit



A range of complete kits is available for both parallel and axial motor mounting.

Characteristics and type codes

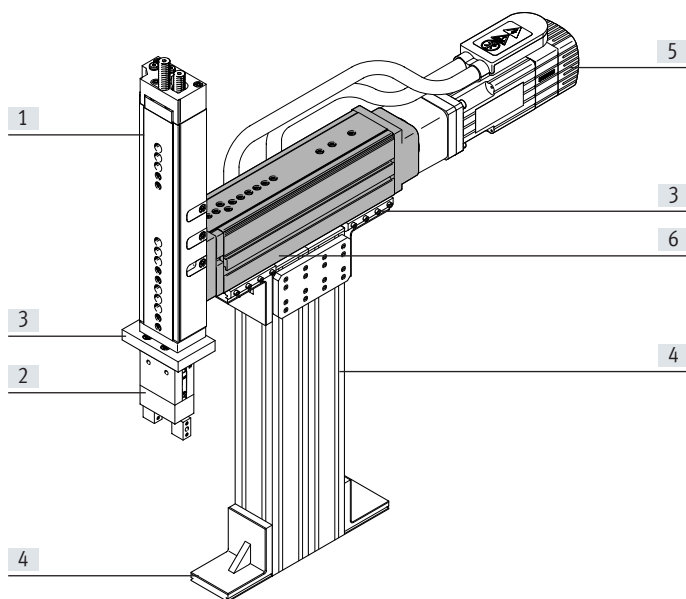

System components and accessories		Description	→ Page/Internet
[1]	Drives	Wide range of combinations possible within handling and assembly technology	drive
[2]	Gripper	Wide range of variations possible within handling and assembly technology	gripper
[3]	Adapter	For drive/drive connections	32
		For drive/gripper connections	adapter-kit
[4]	Basic components	Profiles and profile connections as well as profile/drive connections	basic component
[5]	Motors	Servo and stepper motors, with or without gearbox	motor
[6]	Axes	Wide range of combinations possible within handling and assembly technology	axis
-	Installation components	For a clear, safe layout of electrical cables and tubing	installation component

Type codes

001	Series
EGSL	Mini slide

002	Drive system
BS	Ball screw drive

003	Size
35	35
45	45
55	55
75	75

004	Stroke
50	50
100	100
200	200
250	250
300	300

005	Spindle pitch
3P	3 mm
5P	5 mm
8P	8 mm
10P	10 mm
12.7P	12.7 mm
20P	20 mm

Peripherals overview

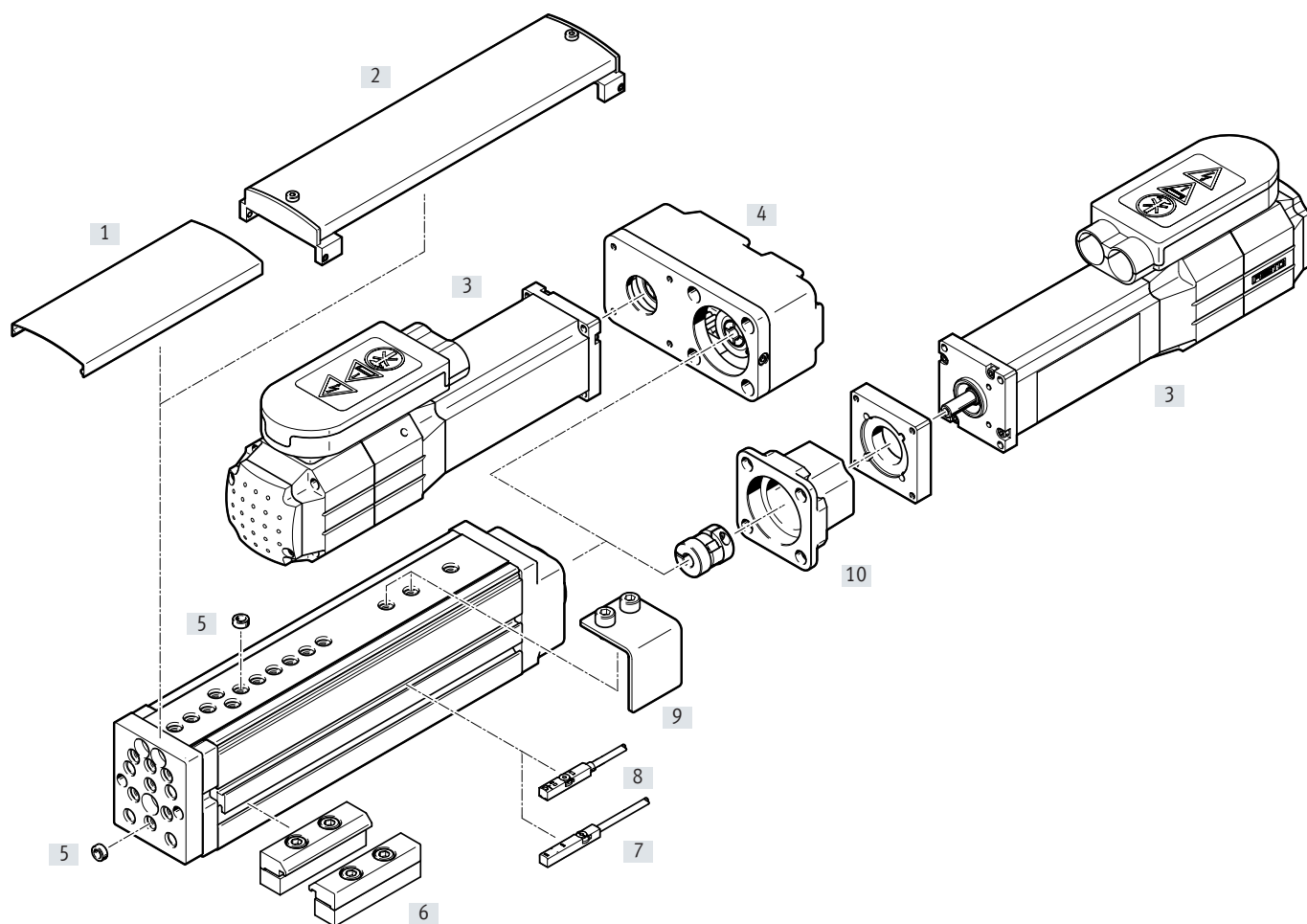



Variants and accessories		
Type	Description	→ Page/Internet
[1] Cover EASC-...	<ul style="list-style-type: none"> For protection, so that no foreign parts can get into the guide The cover can be shortened by the customer as required 	30
[2] Cover EASC-...-F	<ul style="list-style-type: none"> This cover must be used in combination with the switching lug EAPM For protection, so that no foreign parts can get into the guide 	30
[3] Motor EMME, EMMS	Motors specially matched to the axis, with or without brake	22
[4] Parallel kit EAMM	<ul style="list-style-type: none"> For parallel motor mounting The motor can only be mounted at the side and underneath (comprises: housing, clamping sleeve, toothed belt pulley, toothed belt) 	27
[5] Centring sleeve ZBH	<ul style="list-style-type: none"> For centring loads and attachments Makes lateral mounting on the slide much easier 	31
[6] Profile mounting EAHF-G1, MUE	For mounting the axis	29
[7] Proximity switch SIES-8M	Inductive proximity switch, for T-slot	31
[8] Proximity switch SMT-8	Magnetic proximity switch, for T-slot	31
[9] Switch lug EAPM	For sensing the slide position via proximity sensor SIES	29
[10] Axial kit EAMM	For axial motor mounting (consisting of: coupling, coupling housing and motor flange)	22
- Connecting cable NEBU	For proximity switch SIES or SMT-8-...-B	31

Data sheet

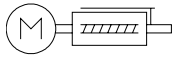
Function



-  Size
35, 45, 55, 75
-  Stroke length
50 ... 300 mm

 **Note**
All values are based on a room temperature of 20°C.

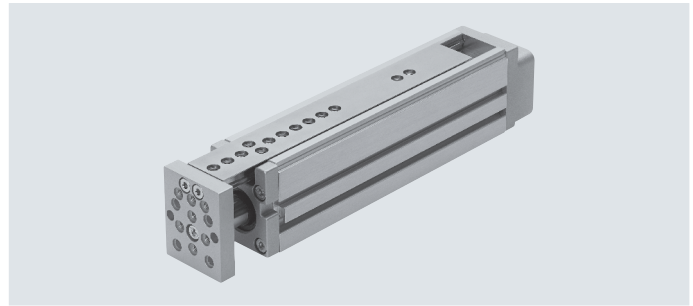

General technical data									
Size		35	45			55		75	
Spindle pitch	[mm/rev]	8	3	10	5	12.7	10	20	
Design		Electric mini slide							
		With ball screw							
		With guide							
Guide		Ball bearing cage guide							
Type of mounting		Via female thread							
		With centring sleeve							
		Via accessories							
Mounting position		Any							
Working stroke	[mm]	50	100, 200		100, 200, 250		100, 200, 300		
Guide value for payload, horizontal	[kg]	2	6	10			14		
Guide value for payload, vertical	[kg]	2	6	10			14		
Continuous feed force F_x	[N]	50	100		200		300		
Max. feed force F_x	[N]	75	150		300		450		
Max. no-load driving torque	[Nm]	0.015	0.090	0.080	0.150	0.135	0.265	0.165	
Max. driving torque ¹⁾	[Nm]	0.127	0.205	0.415	0.415	1.017	1.654	2.231	
Max. radial force ²⁾	[N]	20	120		260		300		
Max. speed	[m/s]	0.5	0.3	1.0	0.4	1.0	0.65	1.3	
Nominal acceleration	[m/s ²]	15							
Max. acceleration ³⁾	[m/s ²]	25							
Repetition accuracy	[mm]	±0.015							
Max. reversing backlash ⁴⁾	[µm]	≤50							

- 1) Friction and acceleration torque of the rotating mass taken into consideration
- 2) At the drive shaft
- 3) The max. acceleration is dependent on the moving mass, the driving torque and the max. feed force
- 4) In new condition

Operating and environmental conditions									
Size		35	45			55		75	
Ambient temperature	[°C]	0 ... +60							
Degree of protection		IP40							
Duty cycle	[%]	100							
Noise level	[dB(A)]	60			65				
Maintenance interval		Life-time lubrication							

Data sheet

Weight [kg]			
Size	35	45	
Stroke [mm]	50	100	200
Product weight	0.6	1.6	2.2
Moving mass	0.3	0.7	0.9
Dead weight of guide rail and yoke plate	0.13	0.4	0.58

Size	55			75		
Stroke [mm]	100	200	250	100	200	300
Product weight	2.6	3.4	4.1	5.1	6.5	8.1
Moving mass	1.2	1.5	1.8	2.3	2.9	3.4
Dead weight of guide rail and yoke plate	0.61	0.87	1.07	1.2	1.64	2.07

Mass moment of inertia – for sizing the motor			
Size	35	45	
Spindle pitch [mm/rev]	8	3	10
Stroke [mm]	50	100	200
J_0 [kg mm ²]	4.26	4.59	5.14
J_L per kg payload [kg mm ² /kg]	1.62	0.23	0.23

Size	55						75					
Spindle pitch [mm/rev]	5			12.7			10			20		
Stroke [mm]	100	200	250	100	200	250	100	200	300	100	200	300
J_0 [kg mm ²]	13.52	14.77	15.74	18.27	21.13	23.27	86.95	96.49	106.67	105.12	119.45	134.59
J_L per kg payload [kg mm ² /kg]	0.63	0.63	0.63	4.09	4.09	4.09	2.53	2.53	2.53	10.13	10.13	10.13

The mass moment of inertia J_A of the entire axis is calculated as follows:

$$J_A = J_0 + J_L \times m_{\text{payload}} [\text{kg}]$$

The inertia of the motor mounting kit and motor is not taken into consideration here.

Materials

Sectional view

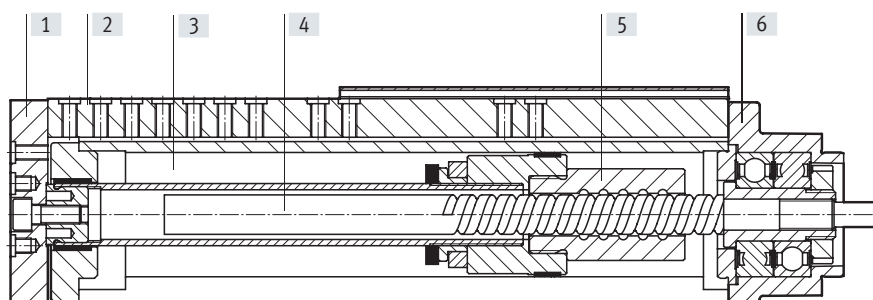

Axis	
[1] Yoke plate	Anodised wrought aluminium alloy
[2] Guide rail	Rolled steel
[3] Housing	Anodised wrought aluminium alloy
[4] Spindle	Rolled steel
[5] Spindle nut	Rolled steel
[6] Cover	Painted aluminium
Note on materials	RoHS-compliant
	Contains paint-wetting impairment substances

Data sheet

Combination options

Via guide

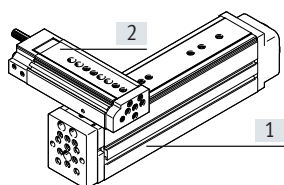

Direct mounting

		[1] Basic drive							
		EGSL-35		EGSL-45		EGSL-55		EGSL-75	
[2] Add-on drive	EGSL-35	1088327	HMSV-73	1088338	HMSV-74	1088338	HMSV-74	–	
	EGSL-45	–	–	1088338	HMSV-74	1088338	HMSV-74	1089092	HMSV-75
	EGSL-55	–	–	–	–	1088338	HMSV-74	1089092	HMSV-75
	EGSL-75	–	–	–	–	–	–	1089092	HMSV-75
	DGSL-4	1088327	HMSV-73	–	–	–	–	–	
	DGSL-6	1088327	HMSV-73	–	–	–	–	–	
	DGSL-8	1088327	MSV-73	ZBV-M5-7	ZBV-M5-7	ZBV-M5-7	ZBV-M5-7	–	
	DGSL-10	1088327	HMSV-73	ZBV-M5-7	ZBV-M5-7	ZBV-M5-7	ZBV-M5-7	–	
	DGSL-12	–	–	M5x14 ZBH-7	M5x16 ZBH-7	M5x16 ZBH-7	M5x16 ZBH-7	ZBV-M6-9	
	DGSL-16	–	–	M5x14 ZBH-7	M5x16 ZBH-7	M5x16 ZBH-7	M5x16 ZBH-7	ZBV-M6-9	
DGSL-20	–	–	–	–	–	–	M6x20 ZBH-9		

Via yoke plate

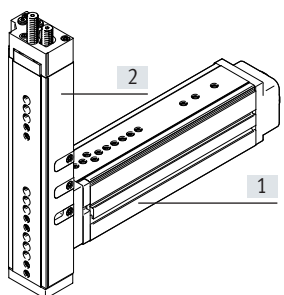

Direct mounting

		[1] Basic drive							
		EGSL-35		EGSL-45		EGSL-55		EGSL-75	
[2] Add-on drive	EGSL-35	M4x12 ZBH-7	–	1088295	HMSV-71	1088295	HMSV-71	–	
	EGSL-45	–	–	M5x12 ZBH-7	M5x14 ZBH-7	M5x14 ZBH-7	M5x14 ZBH-7	1088311	HMSV-72
	EGSL-55	–	–	–	–	M5x14 ZBH-7	M5x14 ZBH-7	1088311	HMSV-72
	EGSL-75	–	–	–	–	–	–	M6x18 ZBH-9	–
	DGSL-4	1088262	HMSV-70	–	–	–	–	–	
	DGSL-6	1088262	HMSV-70	–	–	–	–	–	
	DGSL-8	1088262	HMSV-70	ZBV-M5-7	ZBV-M5-7	ZBV-M5-7	ZBV-M5-7	–	
	DGSL-10	1088262	HMSV-70	ZBV-M5-7	ZBV-M5-7	ZBV-M5-7	ZBV-M5-7	–	
	DGSL-12	–	–	M5x14 ZBH-7	M5x12 ZBH-7	M5x12 ZBH-7	M5x12 ZBH-7	ZBV-M6-9	
	DGSL-16	–	–	M5x14 ZBH-7	M5x12 ZBH-7	M5x12 ZBH-7	M5x12 ZBH-7	ZBV-M6-9	
DGSL-20	–	–	–	–	–	–	M6x20 ZBH-9		

 **Note**

Ordering data for centring sleeves ZBH and connecting sleeves ZBV → page 31.

Data sheet

Parallelism [mm]

The term parallelism refers to the accuracy of alignment between the mounting surface and the slide surface. Specifications apply in the retracted state.

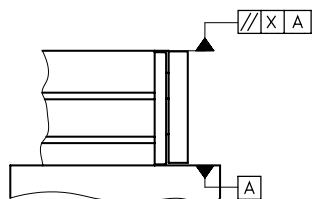

Size	Stroke [mm]	35	45	55	75
Parallelism X	50	0.03	–	–	–
	100	–	0.05	0.05	0.05
	200	–	0.1	0.1	0.1
	250	–	–	0.125	–
	300	–	–	–	0.15

Linearity [mm]

Linearity refers to the max. difference between the normal position and the reference plane experienced at any point of the moving axis component (e.g. slide) when traversing the entire stroke.

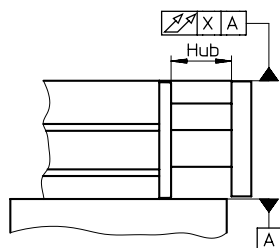

Size	Stroke [mm]	35	45	55	75
Linearity X	50	0.02	–	–	–
	100	–	0.04	0.04	0.04
	200	–	0.08	0.08	0.08
	250	–	–	0.10	–
	300	–	–	–	0.12

Data sheet

Dynamic characteristic load values

The indicated forces and torques refer to the centre of the guide.
These values must not be exceeded during dynamic operation.

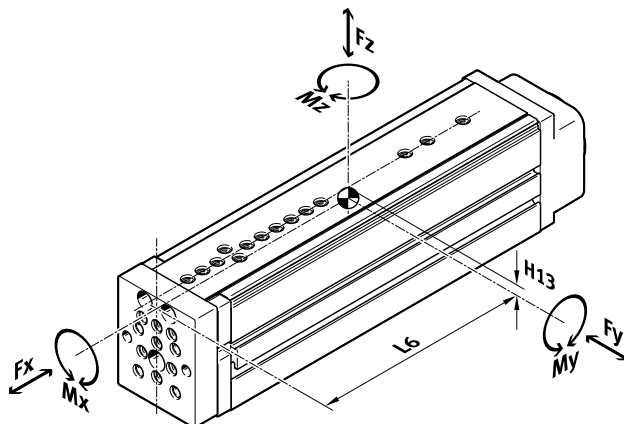

If the axis is simultaneously subjected to several of the indicated forces, the following equation (guide comparison index f_v) must be satisfied in addition to the indicated maximum loads:

Calculating the load comparison factor:

$$f_v = \frac{|F_{y1}|}{F_{y2}} + \frac{|F_{z1}|}{F_{z2}} + \frac{|M_{x1}|}{M_{x2}} + \frac{|M_{y1}|}{M_{y2}} + \frac{|M_{z1}|}{M_{z2}} \leq 1$$

F_1/M_1 = dynamic value

F_2/M_2 = maximum value

Permissible forces and torques						Geometric characteristics		
Size	Stroke [mm]	$F_{y_{max}}$ [N]	$F_{z_{max}}$ [N]	$M_{x_{max}}$ [Nm]	$M_{y_{max}}, M_{z_{max}}$ [Nm]	H13 [mm]	L6	
							Retracted [mm]	Advanced [mm]
35								
	50	512	512	6.2	6.0	4.2	83	106
45								
	100	631	631	18.6	16.3	6.4	114	162
	200	291	291	14.3	12.3	6.4	164	262
55								
	100	1 047	1 047	33.1	31.0	6.4	132	180
	200	490	490	24.2	22.6	6.4	182	280
	250	563	563	27.0	33.3	6.4	221	344
75								
	100	1 539	1 539	67.4	47.1	7.6	139	187
	200	714	714	48.5	33.8	7.6	189	287
	300	555	555	46.4	36.5	7.6	241	389

Note

Engineering software

Electric Motion Sizing

www.festo.com/x/electric-motion-sizing

Data sheet

Position of the guide centre

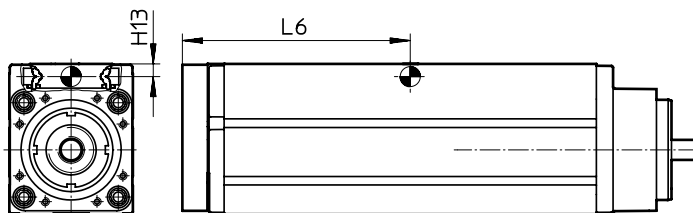

Calculation example

Given:

Type: EGSL-BS-45-100-10P

Stroke length =

100 mm

Lever arm L_x = 30 mmLever arm L_y = 10 mmMass F_z = 5 kgAcceleration a = 0 m/s²

Mounting position: horizontal

To be calculated:

- F_y , F_z , M_x , M_y , M_z
- Proof of functionality with combined load
- Service life estimate

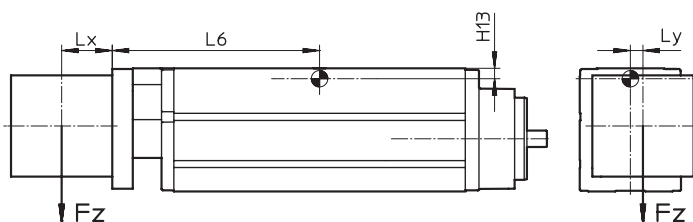

Solution:

 $L_6 = 0.162$ m from table $F_y = 0$ N

$$F_z = m \times g \\ = 5 \text{ kg} \times 9.81 \text{ m/s}^2 = 49.05 \text{ N}$$

$$M_x = F_z \times L_y \\ = 49.05 \text{ N} \times 0.01 \text{ m} = 0.4905 \text{ Nm}$$

$$M_y = F_z \times (L_6 + L_x) \\ = 49.05 \text{ N} \times (0.162 \text{ m} + 0.03 \text{ m}) = 9.42 \text{ Nm}$$

$$M_z = 0 \text{ Nm}$$

Combined load:

$$f_v = \frac{|F_{y1}|}{F_{y2}} + \frac{|F_{z1}|}{F_{z2}} + \frac{|M_{x1}|}{M_{x2}} + \frac{|M_{y1}|}{M_{y2}} + \frac{|M_{z1}|}{M_{z2}} \leq 1$$

$$f_v = 0 + \frac{49.05 \text{ N}}{631 \text{ N}} + \frac{0.49 \text{ Nm}}{18.6 \text{ Nm}} + \frac{9.42 \text{ Nm}}{16.3 \text{ Nm}} + 0 = 0.68$$

According to the graph on page 12, $f_v = 0.68$ gives a service life of approx. 30 million cycles.

Data sheet

Calculating the service life

The service life of the guide depends on the load. To provide a rough indication of the service life of the guide, the graph below plots the load comparison factor f_v against the service life.

The high load capacity and long service life of the guide are only exceeded by the spindle module. The characteristic load values for the spindle are therefore not included in the calculation of the service life.

These values are only theoretical. You must consult your local contact person at Festo for load comparison factors f_v greater than 1.5.

Load comparison factor f_v as a function of service life

Example:

A user wants to move an X kg load. Using the formula (→ page 10) gives a value of 1.5 for the load comparison factor f_v . According to the graph, the guide has a service life of approx. 3 million cycles. Reducing the acceleration reduces the M_z and M_y values. A load comparison factor f_v of 1 now gives a service life of 10 million cycles.

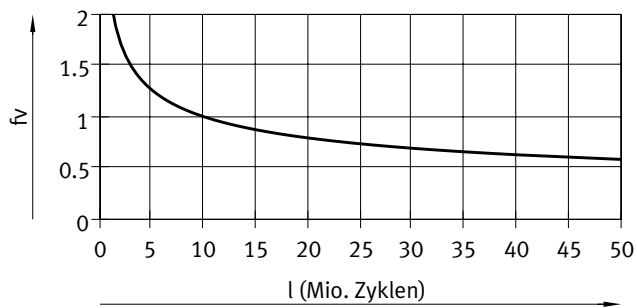

 **Note**
Engineering software
Electric Motion Sizing
www.festo.com/x/electric-motion-sizing

Data sheet

Rotational speed n as a function of feed speed v

EGSL-35

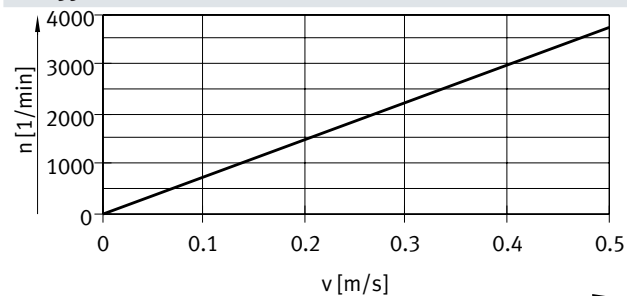

— EGSL-BS-35- ... -8P

EGSL-45

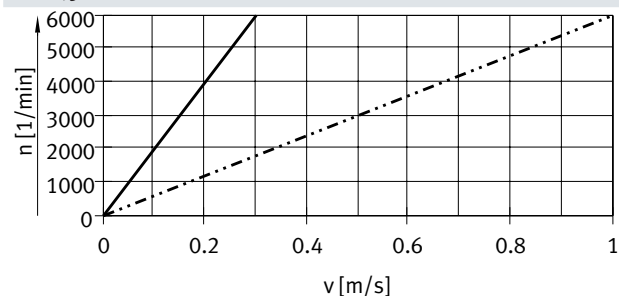

— EGSL-BS-45- ... -3P
 - - - - - EGSL-BS-45- ... -10P

EGSL-55

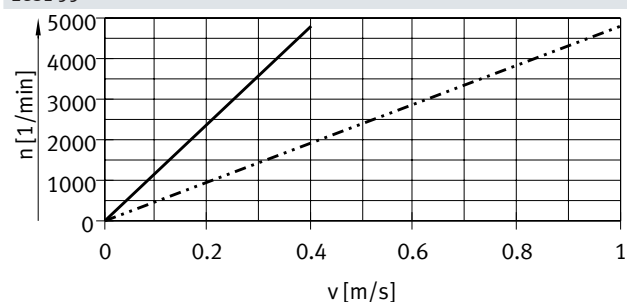

— EGSL-BS-55- ... -5P
 - - - - - EGSL-BS-55- ... -12.7P

EGSL-75

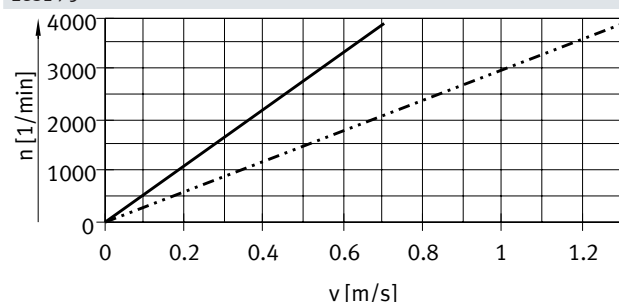

— EGSL-BS-75- ... -10P
 - - - - - EGSL-BS-75- ... -20P

Driving torque M as a function of feed force F

EGSL-35

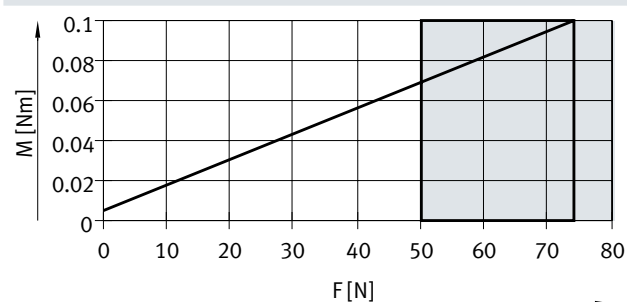

— EGSL-BS-35- ... -8P

EGSL-45

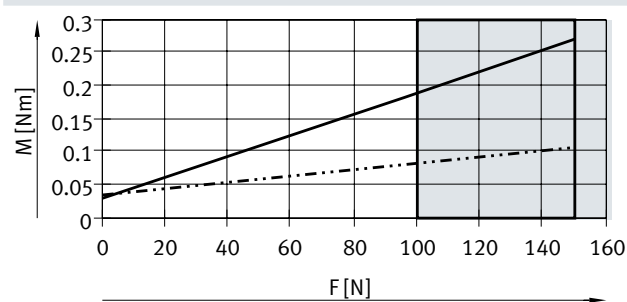

— EGSL-BS-45- ... -10P
 - - - - - EGSL-BS-45- ... -3P

EGSL-55

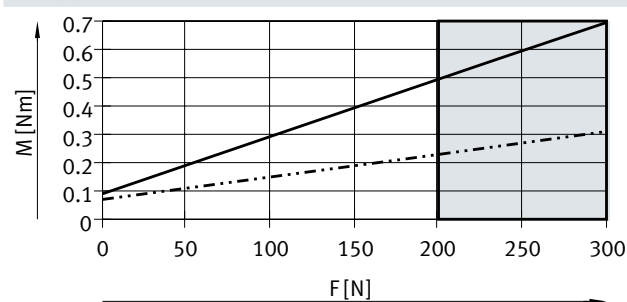

— EGSL-BS-55- ... -12.7P
 - - - - - EGSL-BS-55- ... -5P

EGSL-75

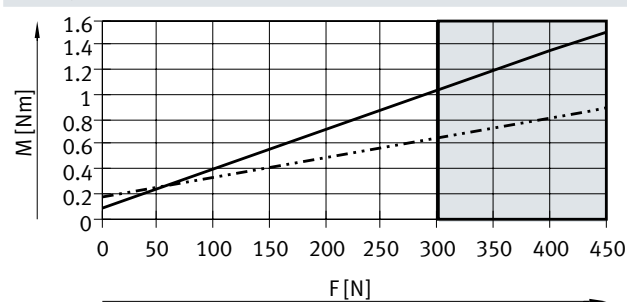

— EGSL-BS-75- ... -20P
 - - - - - EGSL-BS-75- ... -10P

This range should be used only briefly.

Data sheet

Deflection x as a function of force Fz and stroke l

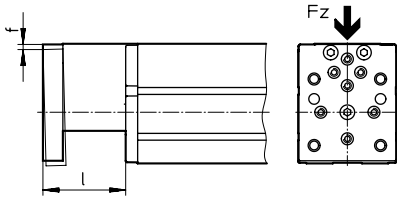

EGSL-35

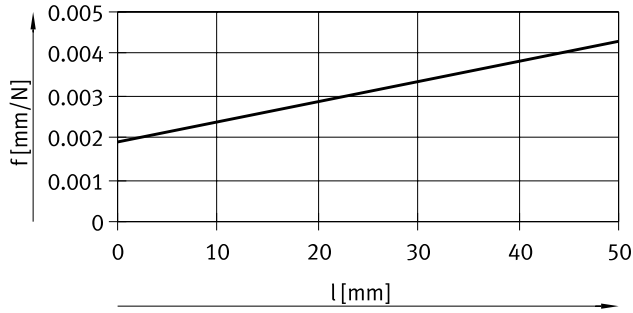

EGSL-BS-35-50

EGSL-45

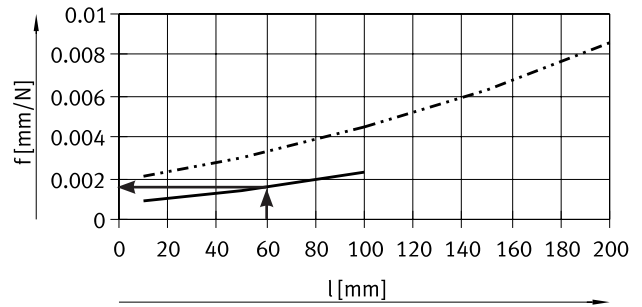

EGSL-BS-45-100
EGSL-BS-45-200

EGSL-55

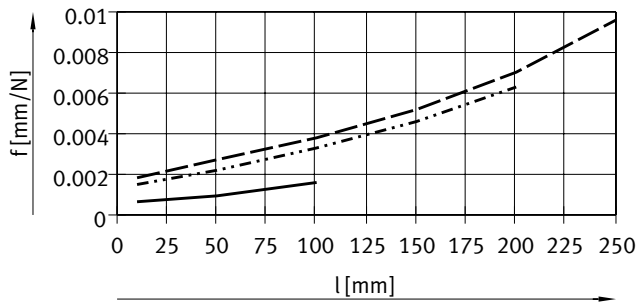

EGSL-BS-55-100
EGSL-BS-55-200
EGSL-BS-55-250

EGSL-75

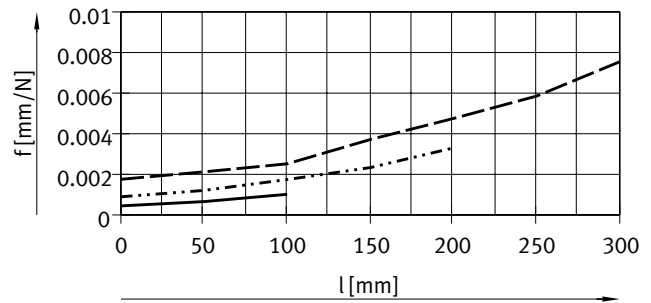

EGSL-BS-75-100
EGSL-BS-75-200
EGSL-BS-75-300

Calculation example

Given:
EGSL-BS-45-100
l = 60 mm
Fz = 30 N
Mounting position: horizontal

Result:
The graph shows a resilience of
f = 0.0015 mm/N with a stroke of
60 mm.

$x = f \times F_2$
 $x = 0.0015 \text{ mm/N} \times 30 \text{ N}$
 $x = 0.045 \text{ mm}$

Data sheet

Deflection x as a function of force F_y and stroke l

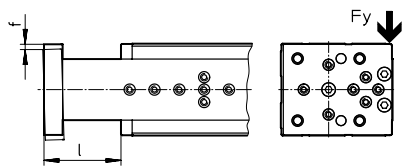

EGSL-35

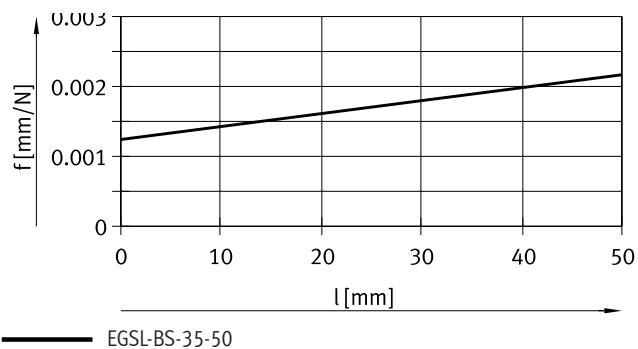

EGSL-BS-35-50

EGSL-45

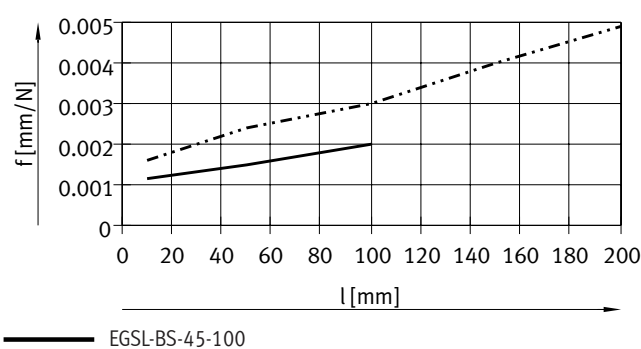

EGSL-BS-45-100

EGSL-BS-45-200

EGSL-55

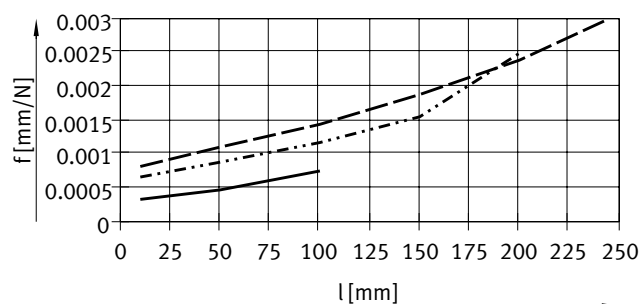

EGSL-BS-55-100

EGSL-BS-55-200

EGSL-BS-55-250

EGSL-75

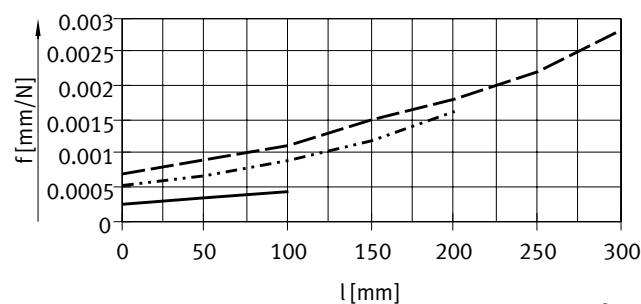

EGSL-BS-75-100

EGSL-BS-75-200

EGSL-BS-75-300

Data sheet

Dimensions

Download CAD data → www.festo.com

Size 35

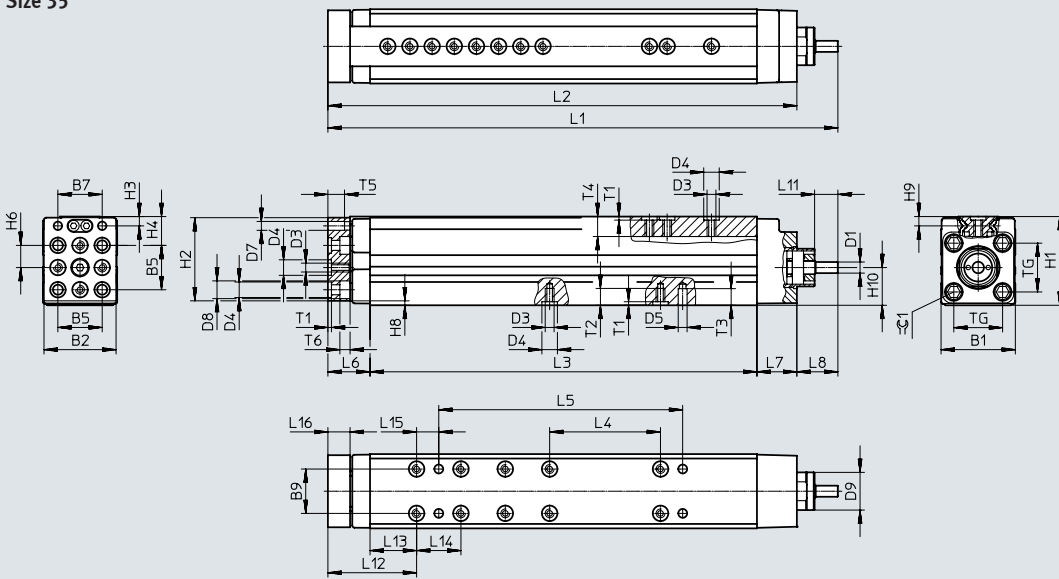

Size 45, 55, 75

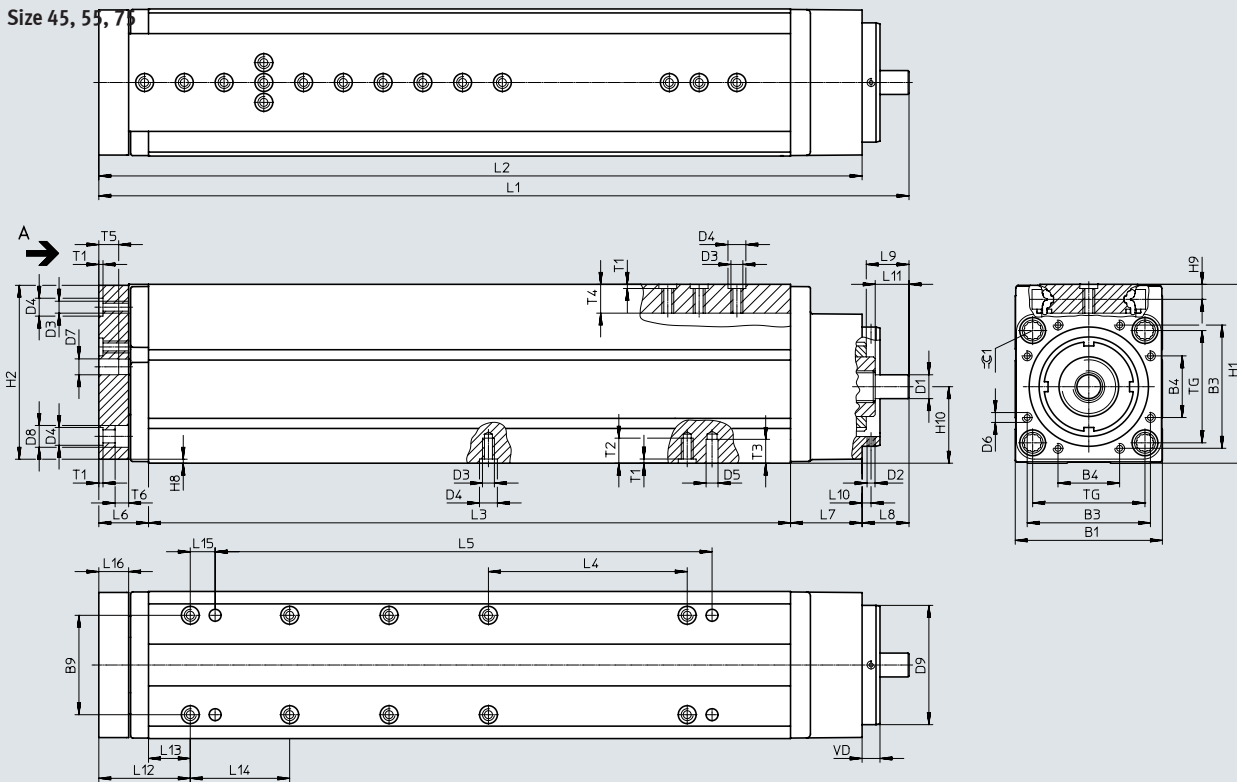

View A

Size 45

Size 55

Size 75

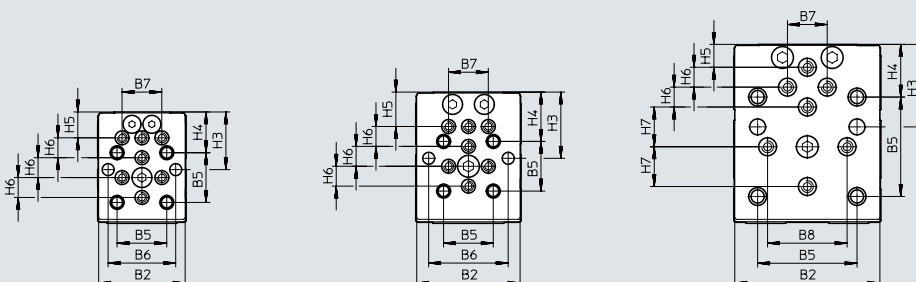

[1] Rubber buffer integrated in the slide. Can be removed when homing to fixed stop.

Data sheet

Size	B1	B2	B3	B4	B5	B6	B7	B8	B9 ±0.5	D1 ∅
35	33.5	33	–	–	20	–	20	–	20	5
45	44.5	43.5	32	19	25	34	20	–	25	6
55	53	52	42	20	25	40	20	–	25	8
75	74	73	62	31	50	–	20	40	50	12

Size	D2	D3	D4 ∅ H7	D5 ∅ H7	D6	D7 ∅	D8 ∅	D9 ∅ g7	H1	H2
35	–	M4	7	4	–	4	8	19	40	37.5
45	M3	M5	7	6	M3	6	10	32	56	53.5
55	M3	M5	7	6	M4	6	10	40	66	63.5
75	M4	M6	9	6	M5	8	11	60	90	87.5

Size	H3	H4	H5	H6	H7	H8	H9	H10	L6	
									2) ±1	3) ±1
35	4.2	13	–	10	–	2	4.2	17+0.09/-0.07	21	19
45	29	20.5	13	10	–	2	6.4	23±0.08	22	20
55	33.3	24.8	17.3	10	–	2	6.4	28.7±0.08	27	25
75	41.5	26.5	11.5	10	20	2	7.6	38.5±0.08	27	25

Size	L7	L8 ±1	L9	L10	L11 ±0.2	L12		L13 ¹⁾	L14 ¹⁾	L15 ±0.1
						2)	3)			
35	18	18.5	–	–	10.5	42	40	21	20	10
45	26	16	16.9	3.5	8	43	41	21	25	12.5
55	30	18.5	14.9	3.5	14	48	46	21	25	12.5
75	36	23.6	21.5	4.5	17	48	46	21	50	12.5

Size	L16	T1 ±0.1	T2	T3	T4	T5	T6	TG	VD	≈ 1
35	10	1.6	7.6	7.5	9	7.5	4.6	22	–	5
45	10	1.6	8.1	7.5	12.4	7.5	5.7	32.5	7	6
55	15	1.6	8.6	8.5	12.4	10	8.7	38	7	6
75	15	2.1	12.6	12	14.5	10	6.8	56.5	9	8

Size	Stroke [mm]	L1		L2		L3 –0.2	L4 ¹⁾	L5 ¹⁾ ±0.05
		2) ±1.5	3) ±1.5	2) ±1	3) ±1			
35	50	182	180	163.5	161.5	124.5	–	60
45	100	248	246	232	230	184	75	125
	200	348	346	332	330	284	100	175
55	100	284.5	282.5	266	264	209	100	150
	200	384.5	382.5	366	364	309	100	175
	250	463.5	461.5	445	443	388	100	175
75	100	309.6	307.6	286	284	223	–	150
	200	409.6	407.6	386	384	323	100	250
	300	514.6	512.6	491	489	428	150	350

1) Tolerance for centring hole ±0.02 mm
Tolerance for thread ±0.1 mm

2) With rubber buffer

3) Without rubber buffer: when homing to fixed stop

Data sheet

Hole pattern for mounting threads and centring holes

EGSL-35-50

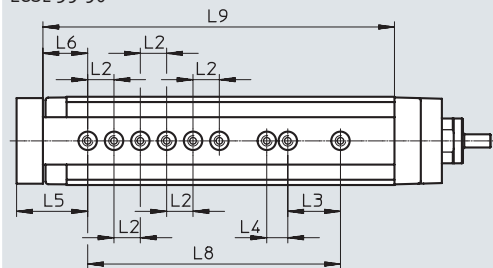

EGSL-45-100

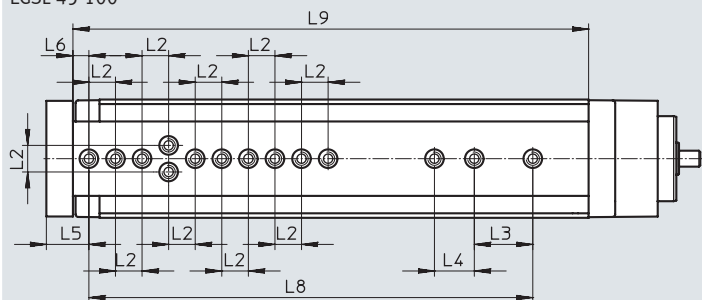

EGSL-45-200

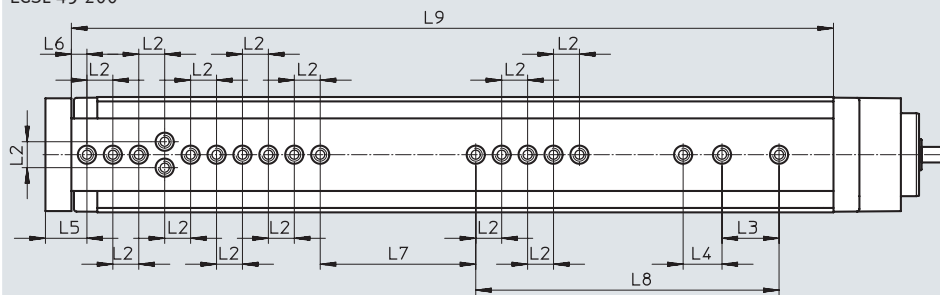

Size	Stroke [mm]	L2 ¹⁾	L3 ¹⁾	L4 ¹⁾	L5	L6	L7 ¹⁾	L8 ¹⁾	L9
35	50	10	20	8	27	17	-	96	133.5
45	100	10	22	15	16	6	-	167	194
	200						60	117	294

1) Tolerance for centring hole ±0.02 mm
Tolerance for thread ±0.1 mm

Data sheet

Hole pattern for mounting threads and centring holes

EGSL-55-100

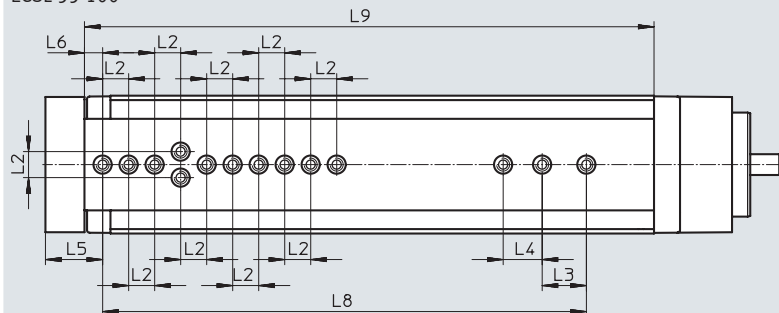

EGSL-55-200

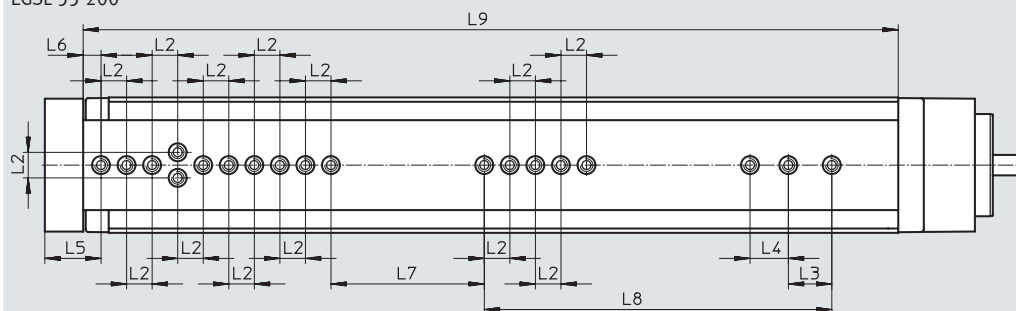

EGSL-55-250

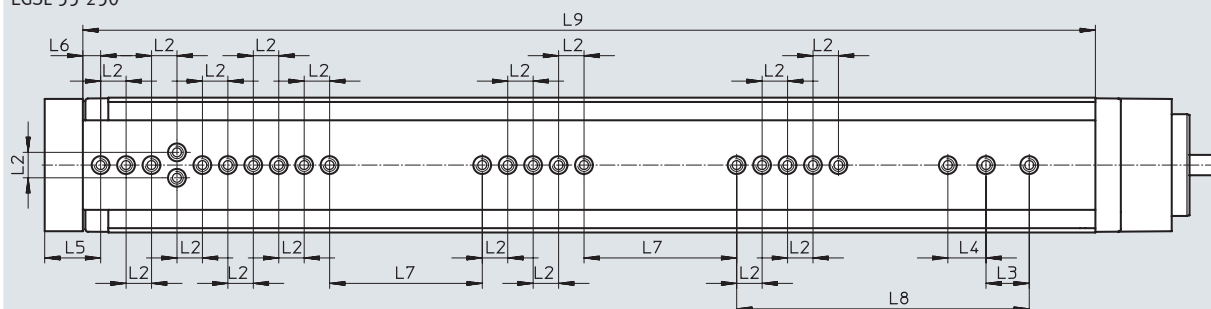

Size	Stroke [mm]	L2 ¹⁾	L3 ¹⁾	L4 ¹⁾	L5	L6	L7 ¹⁾	L8 ¹⁾	L9
55	100	10	17	15	22	7	-	186	219
	200						60	136	319
	250						60	115	398

1) Tolerance for centring hole ±0.02 mm
Tolerance for thread ±0.1 mm

Data sheet

Hole pattern for mounting threads and centring holes

EGSL-75-100

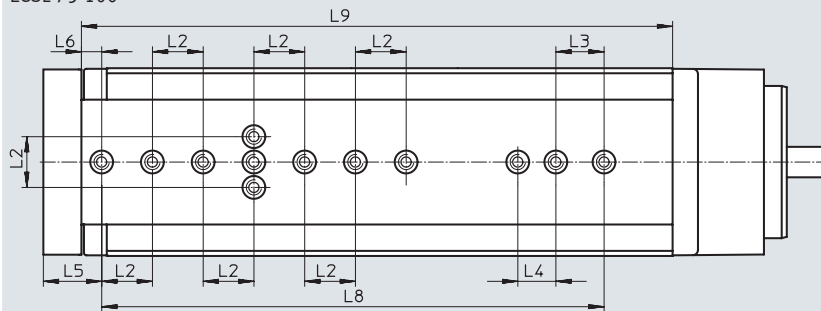

EGSL-75-200

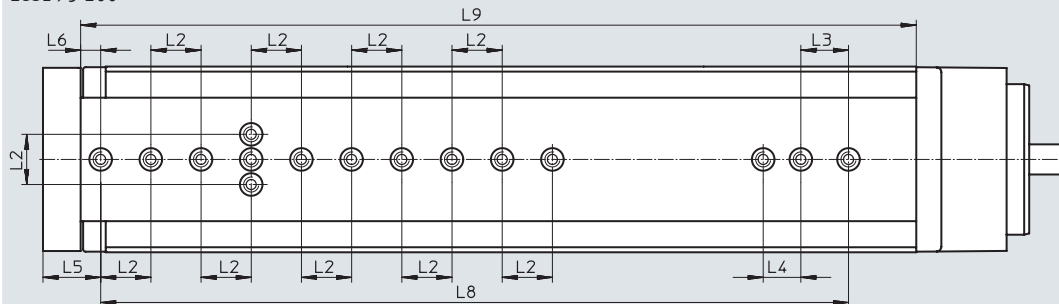

EGSL-75-300

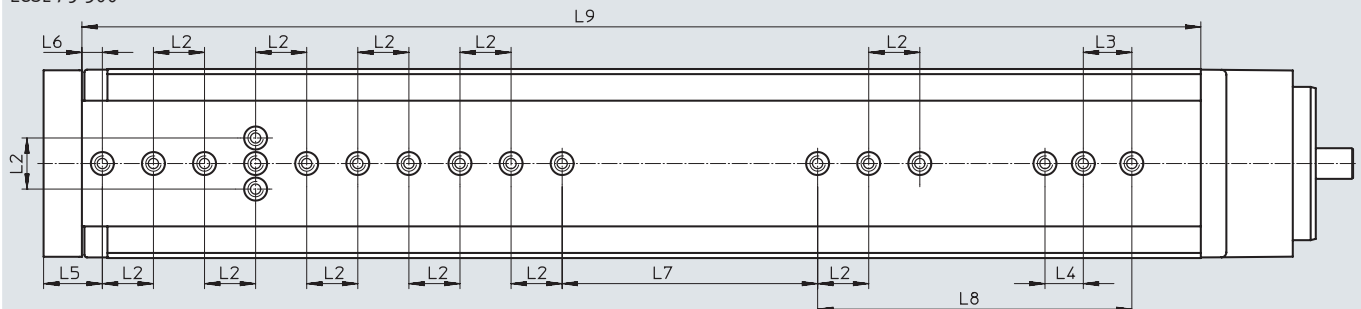

Size	Stroke [mm]	L2 ¹⁾	L3 ¹⁾	L4 ¹⁾	L5	L6	L7 ¹⁾	L8 ¹⁾	L9
75	100	20	19	15	23	8	-	198	233
	200						-	298	333
	300						100	123	438

1) Tolerance for centring hole ±0.02 mm
Tolerance for thread ±0.1 mm

Data sheet

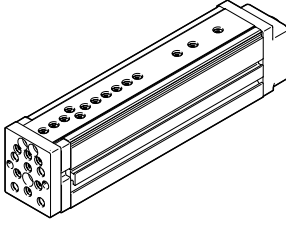
Ordering data	Size	Spindle pitch [mm/rev]	Stroke [mm]	Part no.	Type
	35	8	50	562160	EGSL-BS-35-50-8P
	45	3	100	562225	EGSL-BS-45-100-3P
			200	562226	EGSL-BS-45-200-3P
		10	100	559335	EGSL-BS-45-100-10P
			200	559336	EGSL-BS-45-200-10P
	55	5	100	562227	EGSL-BS-55-100-5P
			200	562228	EGSL-BS-55-200-5P
			250	562229	EGSL-BS-55-250-5P
		12.7	100	559337	EGSL-BS-55-100-12.7P
			200	559338	EGSL-BS-55-200-12.7P
			250	559339	EGSL-BS-55-250-12.7P
	75	10	100	562230	EGSL-BS-75-100-10P
			200	562231	EGSL-BS-75-200-10P
			300	562232	EGSL-BS-75-300-10P
		20	100	559340	EGSL-BS-75-100-20P
200			559341	EGSL-BS-75-200-20P	
300			559342	EGSL-BS-75-300-20P	

Accessories

 **Note**

Depending on the combination of motor and drive, it may not be possible to reach the maximum feed force of the drive.

When using parallel kits, the no-load driving torque of the particular kit must be taken into consideration.

Permissible axis/motor combinations with axial kit

Data sheets → Internet: eamm-a

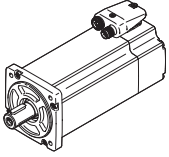
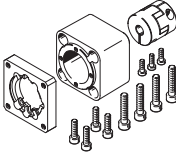
Motor/gear unit ¹⁾	Axial kit	
		
Type	Part no.	Type
EGSL-35		
With servo motor		
EMME-AS-40-...	1981953	EAMM-A-D19-40P
With stepper motor		
EMMS-ST-28-...	1081659	EAMM-A-D19-28A
EMMS-ST-42-...	1087642	EAMM-A-D19-42A
EGSL-45		
With servo motor		
EMME-AS-40-...	1976465	EAMM-A-D32-40P
EMMT-AS-60-..., EMME-AS-60-...	1956054	EAMM-A-D32-60P
With servo motor and gear unit		
EMME-AS-40-... EMGA-40-P-G...-EAS-40	1454238	EAMM-A-D32-40G
EMMT-AS-60-..., EMME-AS-60-... EMGA-60-P-G...-EAS-60	2946760	EAMM-A-D32-60H
With stepper motor		
EMMS-ST-42-...	543148	EAMM-A-D32-42A
EMMS-ST-57-...	550980	EAMM-A-D32-57A
With stepper motor and gear unit		
EMMS-ST-42-... EMGA-40-P-G...-SST-42	1454238	EAMM-A-D32-40G
EMMS-ST-57-... EMGA-60-P-G...-SST-57	2946758	EAMM-A-D32-60G

• Kits for third-party motors → Internet: eamm-a

1) The input torque must not exceed the max. permissible transferable torque of the axial kit.

Accessories

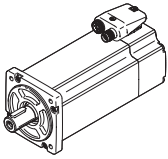
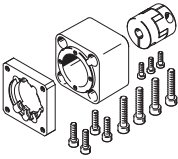
Permissible axis/motor combinations with axial kit		Data sheets → Internet: eamm-a	
Motor/gear unit ¹⁾	Axial kit		
	 <ul style="list-style-type: none"> Kits for third-party motors → Internet: eamm-a 		
Type	Part no.	Type	
EGSL-45			
With integrated drive			
EMCA-EC-67-...	1454239	EAMM-A-D32-67A	
With integrated drive and gear unit			
EMCA-EC-67-...	1454238	EAMM-A-D32-40G	
EMGC-40-...			
EMCA-EC-67-...	2946760	EAMM-A-D32-60H	
EMGC-60-...			
EGSL-55			
With servo motor			
EMMT-AS-60-..., EMME-AS-60-...	1977000	EAMM-A-D40-60P	
With servo motor and gear unit			
EMME-AS-40-...	560282	EAMM-A-D40-40G	
EMGA-40-P-G-...-EAS-40	2256398	EAMM-A-D40-40G-G2 ²⁾	
EMMT-AS-60-..., EMME-AS-60-...	1454242	EAMM-A-D40-60H	
EMGA-60-P-G-...-EAS-60			
With stepper motor			
EMMS-ST-57-...	543154	EAMM-A-D40-57A	
EMMS-ST-87-...	550982	EAMM-A-D40-87A	
With stepper motor and gear unit			
EMMS-ST-42-...	560282	EAMM-A-D40-40G	
EMGA-40-P-G-...-SST-42	2256398	EAMM-A-D40-40G-G2 ²⁾	
EMMS-ST-57-...	2256400	EAMM-A-D40-60G	
EMGA-60-P-G-...-SST-57			
With integrated drive			
EMCA-EC-67-...	1454243	EAMM-A-D40-67A	
With integrated drive and gear unit			
EMCA-EC-67-...	560282	EAMM-A-D40-40G	
EMGC-40-...	2256398	EAMM-A-D40-40G-G2 ²⁾	
EMCA-EC-67-...	1454242	EAMM-A-D40-60H	
EMGC-60-...			

1) The input torque must not exceed the max. permissible transferable torque of the axial kit.

2) The axial kit can be retrofitted from IP40 to IP65 with the help of a seal set EADS-F.

Accessories

Data sheets → Internet: eamm-a

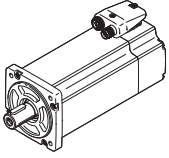
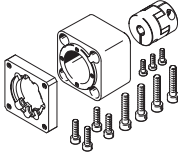
Permissible axis/motor combinations with axial kit			
Motor/gear unit ¹⁾	Axial kit		
	 <ul style="list-style-type: none"> • Kits for third-party motors → Internet: eamm-a 		
Type	Part no.	Type	
EGSL-75			
With servo motor			
EMMT-AS-80-..., EMME-AS-80-...	1977073	EAMM-A-D60-80P	
EMMT-AS-100-..., EMME-AS-100-...,	550983	EAMM-A-D60-100A	
With servo motor and gear unit			
EMMT-AS-60-..., EMME-AS-60-... EMGA-60-P-G...-EAS-60	1454245	EAMM-A-D60-60H	
EMMT-AS-80-..., EMME-AS-80-... EMGA-80-P-G...-EAS-80	1499402	EAMM-A-D60-80G	
EMMT-AS-100-..., EMME-AS-100-..., EMGA-80-P-G...-SAS-100	1499402	EAMM-A-D60-80G	
With stepper motor			
EMMS-ST-87-...	543162	EAMM-A-D60-87A	
With stepper motor and gear unit			
EMMS-ST-57-...	560283	EAMM-A-D60-60G	
EMGA-60-P-G...-SST-57	2256696	EAMM-A-D60-60G-G2 ²⁾	
EMMS-ST-87-... EMGA-80-P-G...-SST-87	1499402	EAMM-A-D60-80G	
With integrated drive and gear unit			
EMCA-EC-67-... EMGC-60-...	1454245	EAMM-A-D60-80H	

1) The input torque must not exceed the max. permissible transferable torque of the axial kit.

2) The axial kit can be retrofitted from IP40 to IP65 with the help of a seal set EADS-F.

Accessories

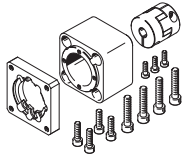
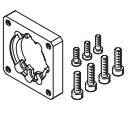
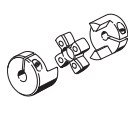
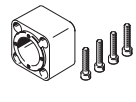
Ordering data – Individual components			
Axial kit	Comprising: Motor flange	Coupling	Coupling housing
			
Part no. Type	Part no. Type	Part no. Type	Part no. Type
EGSL-35			
1199152 EAMM-A-D19-40A	1199144 EAMF-A-28D-40A	543419 EAMC-16-20-5-6	1087585 EAMK-A-D19-28D
1981953 EAMM-A-D19-40P	1982014 EAMF-A-28D-40P	562677 EAMC-16-20-5-8	1087585 EAMK-A-D19-28D
1081659 EAMM-A-D19-28A	1087613 EAMF-A-28D-28A	562676 EAMC-16-20-5-5	1087585 EAMK-A-D19-28D
1087642 EAMM-A-D19-42A	1087630 EAMF-A-28D-42A	562676 EAMC-16-20-5-5	1087585 EAMK-A-D19-28D
EGSL-45			
543147 EAMM-A-D32-40A	552163 EAMF-A-28B-40A	543420 EAMC-16-20-6-6	552155 EAMK-A-D32-28B
1454238 EAMM-A-D32-40G	1460095 EAMF-A-44C-40G-S1	562681 EAMC-30-32-6-10	551006 EAMK-A-D32-44A/C
1976465 EAMM-A-D32-40P	1976704 EAMF-A-28B-40P	1232854 EAMC-16-20-6-8	552155 EAMK-A-D32-28B
543148 EAMM-A-D32-42A	552164 EAMF-A-28B-42A	543419 EAMC-16-20-5-6	552155 EAMK-A-D32-28B
550979 EAMM-A-D32-55A	529942 EAMF-A-44A/B-55A	551003 EAMC-30-32-6-9	551006 EAMK-A-D32-44A/C
550980 EAMM-A-D32-57A	530081 EAMF-A-44A/B-57A	551002 EAMC-30-32-6-6.35	551006 EAMK-A-D32-44A/C
2946758 EAMM-A-D32-60G	1460105 EAMF-A-44C-60G/H-S1	318577 EAMC-30-32-6-11	551006 EAMK-A-D32-44A/C
2946760 EAMM-A-D32-60H	1460105 EAMF-A-44C-60G/H-S1	1233256 EAMC-30-32-6-14	551006 EAMK-A-D32-44A/C
1956054 EAMM-A-D32-60P	1956846 EAMF-A-44C-60P	1233256 EAMC-30-32-6-14	551006 EAMK-A-D32-44A/C
1454239 EAMM-A-D32-67A	1476305 EAMF-A-44A/B/C-67A-S1	551003 EAMC-30-32-6-9	551006 EAMK-A-D32-44A/C

Accessories

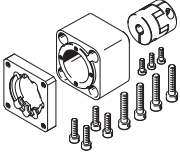
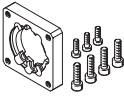
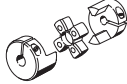
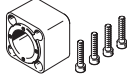
Ordering data – Individual components			
Axial kit	Comprising:		
	Motor flange 	Coupling 	Coupling housing 
Part no. Type	Part no. Type	Part no. Type	Part no. Type
EGSL-55			
560282 EAMM-A-D40-40G	550986 EAMF-A-44A/B-40G	558029 EAMC-30-32-8-10	552157 EAMK-A-D40-44A/C
2256398 EAMM-A-D40-40G-G2	1460095 EAMF-A-44C-40G-S1	558029 EAMC-30-32-8-10	552157 EAMK-A-D40-44A/C
543153 EAMM-A-D40-55A	529942 EAMF-A-44A/B-55A	543423 EAMC-30-32-8-9	552157 EAMK-A-D40-44A/C
543154 EAMM-A-D40-57A	530081 EAMF-A-44A/B-57A	543421 EAMC-30-32-6.35-8	552157 EAMK-A-D40-44A/C
2256400 EAMM-A-D40-60G	1460105 EAMF-A-44C-60G/H-S1	551004 EAMC-30-32-8-11	552157 EAMK-A-D40-44A/C
1454242 EAMM-A-D40-60H	1460105 EAMF-A-44C-60G/H-S1	562682 EAMC-30-32-8-14	552157 EAMK-A-D40-44A/C
1977000 EAMM-A-D40-60P	1956846 EAMF-A-44C-60P	562682 EAMC-30-32-8-14	552157 EAMK-A-D40-44A/C
1454243 EAMM-A-D40-67A	1476305 EAMF-A-44A/B/C-67A-S1	543423 EAMC-30-32-8-9	552157 EAMK-A-D40-44A/C
550981 EAMM-A-D40-70A	529943 EAMF-A-44A/B-70A	551004 EAMC-30-32-8-11	552157 EAMK-A-D40-44A/C
550982 EAMM-A-D40-87A	530082 EAMF-A-44A/B-87A	551004 EAMC-30-32-8-11	552157 EAMK-A-D40-44A/C
EGSL-75			
560283 EAMM-A-D60-60G	550987 EAMF-A-64A/B-60G/H	543424 EAMC-42-50-11-12	552160 EAMK-A-D60-64B
2256696 EAMM-A-D60-60G-G2	2256289 EAMF-A-64B-60G/H-S1	543424 EAMC-42-50-11-12	552160 EAMK-A-D60-64B
1454245 EAMM-A-D60-60H	2256289 EAMF-A-64B-60G/H-S1	1455671 EAMC-42-50-12-14	552160 EAMK-A-D60-64B
543161 EAMM-A-D60-70A	529945 EAMF-A-64A/B-70A	543424 EAMC-42-50-11-12	552160 EAMK-A-D60-64B
1499402 EAMM-A-D60-80G	2843290 EAMF-A-64C-80G-S1	2138701 EAMC-42-50-12-20	551007 EAMK-A-D60-64C
1977073 EAMM-A-D60-80P	1977113 EAMF-A-64A/C-80P	551005 EAMC-42-50-12-19	551007 EAMK-A-D60-64C
543162 EAMM-A-D60-87A	533140 EAMF-A-64A/B-87A	543424 EAMC-42-50-11-12	552160 EAMK-A-D60-64B
550983 EAMM-A-D60-100A	529947 EAMF-A-64A/C/D-100A	551005 EAMC-42-50-12-19	551007 EAMK-A-D60-64C

Accessories

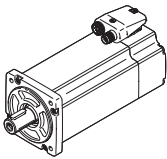
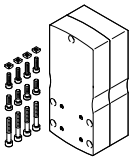
Permissible axis/motor combinations with parallel kit		Data sheets → Internet: eamm-u	
Motor/gear unit ¹⁾	Parallel kit		
		<ul style="list-style-type: none"> The kit can be mounted in all directions Kits for third-party motors → Internet: eamm-u 	
Type	Part no.	Type	
EGSL-45			
With servo motor			
EMME-AS-40-...	2153283	EAMM-U-50-D32-40P-78	
EMMT-AS-60-..., EMME-AS-60-...	2619586	EAMM-U-70-D32-60P-96	
With stepper motor			
EMMS-ST-42-...	1201607	EAMM-U-50-D32-42A-78	
EMMS-ST-57-...	1210419	EAMM-U-60-D32-57A-91	
With integrated drive			
EMCA-EC-67-...	1577063	EAMM-U-60-D32-67A-91	
With servo motor and gear unit			
EMME-AS-40-..., EMGA-40-P-...	1577358	EAMM-U-60-D32-40G-91	
EMMT-AS-60-..., EMME-AS-60-..., EMGA-60-P-...-EAS ²⁾	2778393	EAMM-U-70-D32-60H-96	
With stepper motor and gear unit			
EMMS-ST-42-..., EMGA-40-P-...-SST ²⁾	1577358	EAMM-U-60-D32-40G-91	
EMMS-ST-57-..., EMGA-60-P-...-SST ²⁾	2748181	EAMM-U-70-D32-60G-96	
With integrated drive and gear unit			
EMCA-EC-67-..., EMGC-40-P-...	1577358	EAMM-U-60-D32-40G-91	
EMCA-EC-67-..., EMGC-60-P-... ²⁾	2778393	EAMM-U-70-D32-60H-96	
EGSL-55			
With servo motor			
EMMT-AS-60-..., EMME-AS-60-...	2617488	EAMM-U-70-D40-60P-96	
With stepper motor			
EMMS-ST-57-...	1210442	EAMM-U-60-D40-57A-91	
EMMS-ST-87-...	1215802	EAMM-U-86-D40-87A-102	
With integrated drive			
EMCA-EC-67-...	1577083	EAMM-U-60-D40-67A-91	

1) The input torque must not exceed the max. permissible transferable torque of the parallel kit.

2) Gear unit output shaft diameter: EMGA-60-P-...SAS/SST: 11 mm; EMGA-60-P-...EAS, EMGC-60-P: 14 mm

Accessories

Data sheets → Internet: eamm-u

Permissible axis/motor combinations with parallel kit

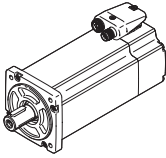
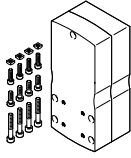
Motor / gear unit ¹⁾	Parallel kit	
		<ul style="list-style-type: none"> The kit can be mounted in all directions Kits for third-party motors → Internet: eamm-u
Type	Part no.	Type
EGSL-55		
With servo motor and gear unit		
EMME-AS-40-..., EMGA-40-P-...	1577165	EAMM-U-60-D40-40G-91
EMMT-AS-60-..., EMME-AS-60-... EMGA-60-P-...-EAS ²⁾	2786101	EAMM-U-70-D40-60H-96
	1586496	EAMM-U-86-D40-60H-102
With stepper motor and gear unit		
EMMS-ST-42-... EMGA-40-P-...	1577165	EAMM-U-60-D40-40G-91
EMMS-ST-57-... EMGA-60-P-...-SST ²⁾	2785471	EAMM-U-70-D40-60G-96
	1586445	EAMM-U-86-D40-60G-102
With integrated drive and gear unit		
EMCA-EC-67-... EMGC-40-P-...	1577165	EAMM-U-60-D40-40G-91
EMCA-EC-67-... EMGC-60-P-... ²⁾	2786101	EAMM-U-70-D40-60H-96
	1586496	EAMM-U-86-D40-60H-102
EGSL-75		
With servo motor		
EMME-AS-80-...	2155875	EAMM-U-86-D60-80P-102
With stepper motor		
EMMS-ST-87-...	1215784	EAMM-U-86-D60-87A-102
With servo motor and gear unit		
EMMT-AS-60-..., EMME-AS-60-... EMGA-60-P-...-EAS ²⁾	1586276	EAMM-U-86-D60-60H-102
	1542264	EAMM-U-110-D60-60H-120
EMMT-AS-80-..., EMME-AS-80-... EMGA-80-P-...	1532949	EAMM-U-110-D60-80G-120
With stepper motor and gear unit		
EMMS-ST-57-... EMGA-60-P-...-SST ²⁾	1586347	EAMM-U-86-D60-60G-102
	1543240	EAMM-U-110-D60-60G-120
EMMT-AS-80-..., EMME-AS-80-... EMGA-80-P-...	1532949	EAMM-U-110-D60-80G-120
With integrated drive and gear unit		
EMCA-EC-67-... EMGC-60-P-... ²⁾	1586276	EAMM-U-86-D60-60H-102
	1542264	EAMM-U-110-D60-60H-120

1) The input torque must not exceed the max. permissible transferable torque of the parallel kit.

2) Gear unit output shaft diameter: EMGA-60-P-...-SAS/SST: 11 mm; EMGA-60-P-...-EAS, EMGC-60-P: 14 mm

 **Note**

The clamping element EADT is required to adjust the toothed belt pretension for EAMM-U-110.

The motor and/or axis shaft can optionally be supported with a counter bearing EAMG.

Accessories

Profile mounting

EAHF/MUE

Material:

Anodised aluminium

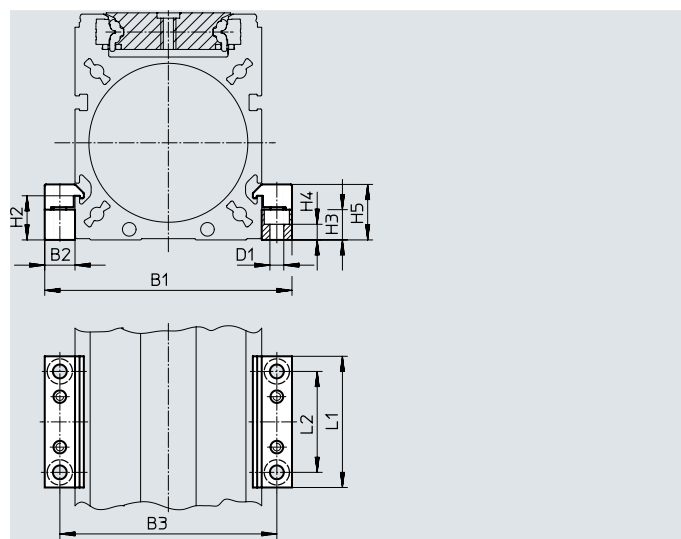

Dimensions and ordering data

For size	B1	B2	B3	D1 ∅	H2	H3
35	49.5	8	41.5	3.4	10.5	10
45	68.5	12	56.5	5.5	12.5	8.3
55	77	12	65	5.5	17.5	12
75	98	12	86	5.5	17.5	12

For size	H4	H5	L1	L2	Weight [g]	Part no.	Type
35	6.8	15.5	40	20	20	1170211	EAHF-G1-35-P
45	2.5	17	52	40	23	1168859	EAHF-G1-45-P
55	6.2	22	52	40	80	558043	MUE-70/80
75	6.2	22	52	40	80	558043	MUE-70/80

Switch lug EAPM

Material:

Galvanised steel

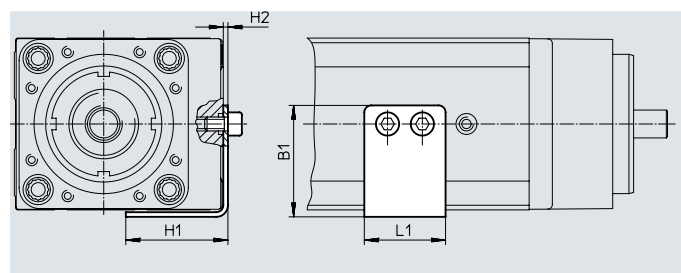

Dimensions and ordering data

For size	B1	H1	H2	L1	Weight [g]	Part no.	Type
35	25.5	25	1.5	17	15	1235029	EAPM-G1-35-SLS
45	32	32.5	2	30	30	1235033	EAPM-G1-45-SLS
55	36	35	2	30	35	1235035	EAPM-G1-55-SLS
75	48	44	2	35	50	1235036	EAPM-G1-75-SLS

 Note

The switch lug should only be attached to the designated threads (guide rail at the back).

Accessories

Cover EASC

Material:

Anodised aluminium

Free of copper and PTFE

EASC-...

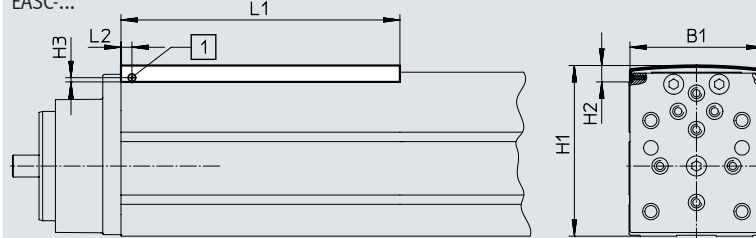

EASC-...-F

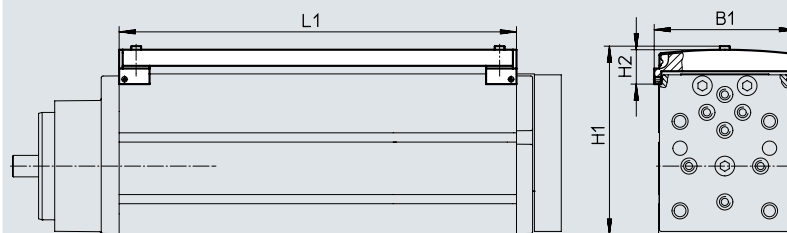

[1] Countersunk screw M2



Dimensions and ordering data



For size	Length [mm]	B1	H1	H2	H3	L1 -0.5	L2 -0.3	Part no.	Type
For use without switch lug									
35	50	32.5	43.2	8.5	2.3	58	6	570819	EASC-G1-35-50
	500 ¹⁾							570874	EASC-G1-35-500
45	100	43.5	59.7	9	2.3	108	6	570822	EASC-G1-45-100
	200							570823	EASC-G1-45-200
	500 ¹⁾							570875	EASC-G1-45-500
55	100	52	69.7	9	2.3	108	6	570824	EASC-G1-55-100
	200							570825	EASC-G1-55-200
	250							570826	EASC-G1-55-250
	500 ¹⁾							570876	EASC-G1-55-500
75	100	73	93.7	9	2.3	108	6	570827	EASC-G1-75-100
	200							570828	EASC-G1-75-200
	300							570829	EASC-G1-75-300
	500 ¹⁾							570877	EASC-G1-75-500
For use with switch lug									
35	50	38.3	55	19.1	-	119.5	-	570830	EASC-G1-35-50-F
45	100	49.7	71.5	19.6	-	179	-	570833	EASC-G1-45-100-F
	200							570834	EASC-G1-45-200-F
55	100	58.2	81.5	19.6	-	204	-	570835	EASC-G1-55-100-F
	200							570836	EASC-G1-55-200-F
	250							570837	EASC-G1-55-250-F
75	100	78.9	105.5	19.4	-	218	-	570838	EASC-G1-75-100-F
	200							570839	EASC-G1-75-200-F
	300							570840	EASC-G1-75-300-F

Note

With the 500 mm covers, the mounting hole must be made by the customer.

1) The cover can be trimmed as required by the customer.

Accessories



Ordering data					
	For size	Description	Part no.	Type	PU ¹⁾
Centring sleeve ZBH²⁾					
	35, 45, 55	For slide and yoke plate	8146544	ZBH-7-B	10
	75		8137184	ZBH-9-B	
Connector sleeve ZBV					
	45, 55	For connecting mini slide EGSL to mini slide DGPL	548803	ZBV-M5-7	3
	75		548804	ZBV-M6-9	

1) Packaging unit

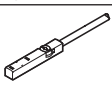
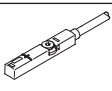
2) Six included in the scope of delivery of the mini slide

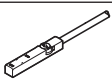
Ordering data – Proximity switches for T-slot, inductive							Data sheets → Internet: sies
	Type of mounting	Switching output	Electrical connection	Cable length [m]	Part no.	Type	
N/O contact							
	Insertable in the slot from above, flush with the cylinder profile	PNP	Cable, 3-wire	7.5	551386	SIES-8M-PS-24V-K-7,5-OE	
			Plug M8x1, 3-pin	0.3	551387	SIES-8M-PS-24V-K-0,3-M8D	
		NPN	Cable, 3-wire	7.5	551396	SIES-8M-NS-24V-K-7,5-OE	
			Plug M8x1, 3-pin	0.3	551397	SIES-8M-NS-24V-K-0,3-M8D	
N/C contact							
	Insertable in the slot from above, flush with the cylinder profile	PNP	Cable, 3-wire	7.5	551391	SIES-8M-PO-24V-K-7,5-OE	
			Plug M8x1, 3-pin	0.3	551392	SIES-8M-PO-24V-K-0,3-M8D	
		NPN	Cable, 3-wire	7.5	551401	SIES-8M-NO-24V-K-7,5-OE	
			Plug M8x1, 3-pin	0.3	551402	SIES-8M-NO-24V-K-0,3-M8D	

Ordering data – Proximity switches for T-slot, magneto-resistive							Data sheets → Internet: smt
	Type of mounting	Switching output	Electrical connection	Cable length [m]	Part no.	Type	
N/O contact							
	Insertable in the slot from above, flush with the cylinder profile, short design	PNP	Cable, 3-wire	2.5	574335	SMT-8M-A-PS-24V-E-2,5-OE	
			Plug M8x1, 3-pin	0.3	574334	SMT-8M-A-PS-24V-E-0.3-M8D	

Ordering data – Connecting cables							Data sheets → Internet: nebu
	Electrical connection, left	Electrical connection, right	Cable length [m]	Part no.	Type		
	Straight socket, M8x1, 3-pin	Cable, open end, 3-wire	2.5	541333	NEBU-M8G3-K-2.5-LE3		
			5	541334	NEBU-M8G3-K-5-LE3		
	Angled socket, M8x1, 3-pin	Cable, open end, 3-wire	2.5	541338	NEBU-M8W3-K-2.5-LE3		
			5	541341	NEBU-M8W3-K-5-LE3		

Accessories

Adapter kit
HMSV

Material:
Wrought aluminium alloy
Free of copper and PTFE
RoHS-compliant

 **Note**
The kit includes the individual mounting interface as well as the necessary mounting material.

Permissible drive/drive combinations with adapter kit

Download CAD data → www.festo.com

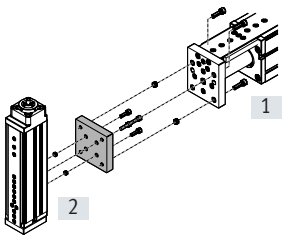
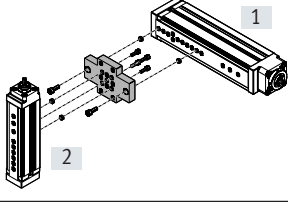
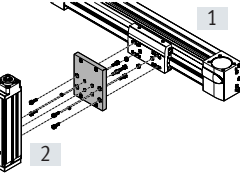
Combination	[1] Drive	[2] Drive	Adapter kit				
	Size	Size	CRC ¹⁾	Part no.	Type	Quantity required	PU ²⁾
EGSL/EGSL	EGSL	EGSL	HMSV				
	35	35	2	–	M4x12 DIN 912 ³⁾	4	–
	45, 55	35		8146544	ZBH-7-B ⁴⁾	4	10
	45	45		1088295	HMSV-71	1	–
	55	45, 55		–	M5x12 DIN 912 ³⁾	4	–
	75	45, 55		8146544	ZBH-7-B ⁴⁾	4	10
	75	75		–	M5x14 DIN 912 ³⁾	4	–
				8146544	ZBH-7-B ⁴⁾	4	10
				1088311	HMSV-72	1	–
	35	35	2	150927	ZBH-9 ⁴⁾	4	10
	45, 55	35, 45		1088327	HMSV-73	1	1
	75	45		1088338	HMSV-74	1	1
	55	55		1089092	HMSV-75	1	1
	75	55, 75		1088338	HMSV-74	1	1
				1089092	HMSV-75	1	1
EGC/EGSL	EGC	EGSL	HMSV				
	50	35	2	1089104	HMSV-76	1	1
	70	35, 45, 55		1089346	HMSV-77	1	1
	80	45, 55, 75		1089520	HMSV-78	1	1
	120	45, 55, 75		1089527	HMSV-79	1	1

- 1) Corrosion resistance class CRC 2 to Festo standard FN 940070
Moderate corrosion stress. Indoor applications in which condensation can occur. External visible parts with primarily decorative surface requirements which are in direct contact with a normal industrial environment.
- 2) Packaging unit.
- 3) The screws listed are not included in the scope of delivery of the drives.
- 4) The centring sleeves are included in the scope of delivery of the drives.

Festo - Your Partner in Automation



1 Festo Inc.
5300 Explorer Drive
Mississauga, ON L4W 5G4
Canada

Festo Customer Interaction Center
Tel: 1 877 463 3786
Fax: 1 877 393 3786
Email: customer.service.ca@festo.com



2 Festo Pneumatic
Av. Ceylán 3,
Col. Tequesquináhuac
54020 Tlalnepantla,
Estado de México

Multinational Contact Center
01 800 337 8669
ventas.mexico@festo.com



3 Festo Corporation
1377 Motor Parkway
Suite 310
Islandia, NY 11749

Festo Customer Interaction Center
1 800 993 3786
1 800 963 3786
customer.service.us@festo.com



4 Regional Service Center
7777 Columbia Road
Mason, OH 45040

Connect with us



www.festo.com/socialmedia



www.festo.com

Subject to change