

## Cantilever axes ELCC

**FESTO**

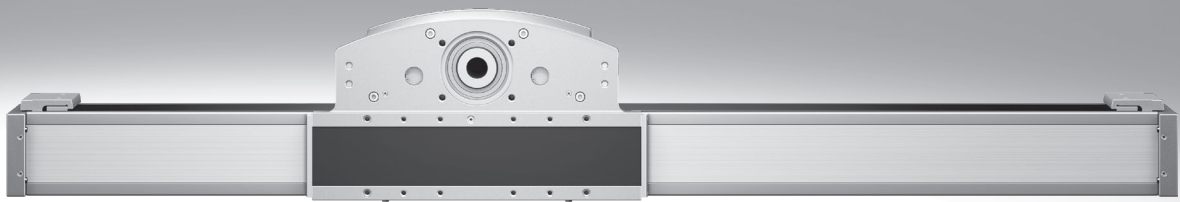

## Key features

## At a glance

- High rigidity thanks to innovative design principle
- Very small moving mass
- Able to move high loads of up to 100 kg vertically
- Optionally with NSF-H1 lubricant for the food zone
- Toothed belt material can be selected from:
  - Chloroprene rubber for long service life
  - Uncoated PU for the food zone
  - PU coated with steel reinforcement cords for long service life and resilience to certain cooling lubricants

## The technology in detail

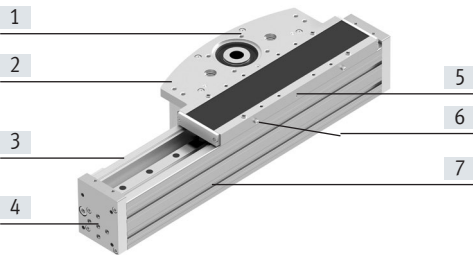

- [1] Interface for motor mounting
- [2] Drive head
- [3] Cantilever profile
- [4] Front end
- [5] Connection for clamping unit or sealing air (available on both sides)
- [6] Connection for lubrication hole (available on both sides)
- [7] Mounting slot for accessories

## Protection against particles

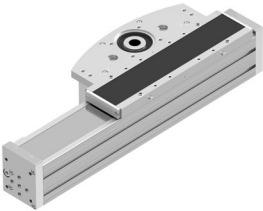

- Stainless steel cover strip provides basic protection for the guide

## Motor attachment (can also be mounted underneath)

## Axial

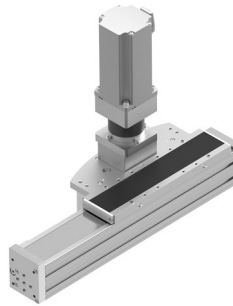

## With right-angle gear unit

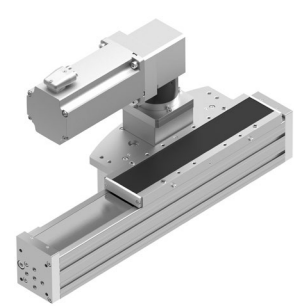

## Additional slide



- Rigidity and load-bearing capacity are increased by having twice as many roller carriages and a greater distance between bearings

## Clamping unit



- For holding loads securely (frictional locking)
- Integrated into the axis so it does not protrude
- Acts directly on the guide (in any position)
- Can also be used for emergency braking operations

## Displacement encoder system

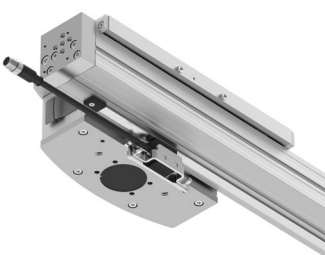

- The position is detected incrementally and without contact
- To improve absolute accuracy
- 2-channel solutions are possible together with the motor encoder and a safety relay unit
- For sizes 60/70 the displacement encoder system is attached on the outside; for sizes 90/110 it is integrated underneath the toothed belt

## Sealing air connection



- Application of negative pressure minimises the dispersal of abraded particles into the environment
- Application of gauge pressure prevents dirt from getting into the axis
- Cannot be used in combination with the clamping unit

## Key features

Complete system comprising toothed belt axis, motor, motor controller and motor mounting kit

Cantilever axis

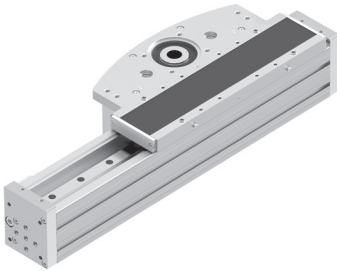

### Motor



Servo motor:  
EMMT-AS, EMME-AS  
Stepper motor:  
EMMS-ST



#### Note

There are complete solutions for the cantilever axis ELCC and the motors ensuring excellent compatibility.

### Servo drive



Servo drive:  
CMMT-AS  
Servo drive for extra-low voltage:  
CMMT-ST

### Motor mounting kit



Kit comprising:

- Motor flange
- Coupling housing
- Coupling
- Screws

Peripherals overview

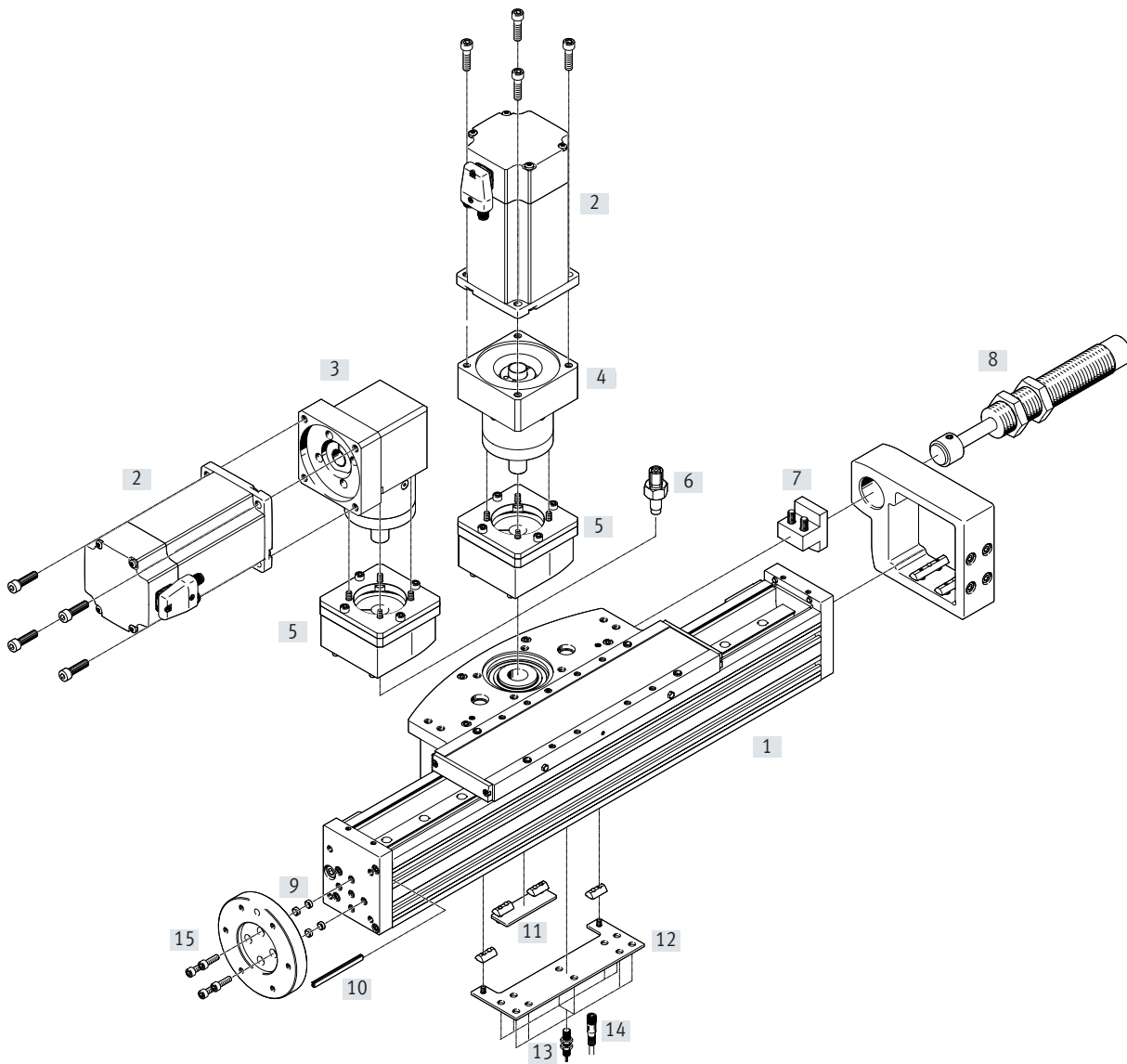

## Peripherals overview

Accessories		
Type	Description	→ Page/Internet
[1] Cantilever axis ELCC	Electric axis	7
[2] Motor EMME	Motors specially matched to the axis, with or without gear unit, with or without brake	23
[3] Right-angle gear unit EMGA-...-A	With gear ratio $i = 3$ and $i = 5$	23
[4] Gear unit EMGA-...-A	With gear ratio $i = 3$ and $i = 5$	23
[5] Axial kit EAMM	For axial motor mounting (comprises: coupling, coupling housing and motor flange)	23
[6] Drive shaft EAMB	<ul style="list-style-type: none"> <li>• Can, if required, be used as an alternative interface</li> <li>• No drive shaft is required for the axis/motor combinations → page 25</li> </ul>	29
[7] Shock absorber retainer DAYP-E21	For mounting a shock absorber on the axis	27
[8] Shock absorber YSR	<ul style="list-style-type: none"> <li>• Protects the axis from damage in the event of power failure or unintended lowering</li> <li>• Max. impact energy must be observed</li> </ul>	29
[9] Centring pin/sleeve ZBS, ZBH	<ul style="list-style-type: none"> <li>• For centring attachments on the front end</li> <li>• For mounting the drive head</li> </ul>	29
[10] Slot cover ABP	For protecting against contamination	29
[11] Switch lug DASI-E21-SL	For sensing the slide position	26
[12] Sensor bracket DASI-E21-SR	For mounting the inductive proximity switches (round design) on the axis	26
[13] Proximity switch, M8 SIEN-M8	Inductive proximity switch, round design	30
[14] Connecting cable NEBU	For proximity switch SIEN-M8	30
[15] Adapter kit DHAA-R	For interface to ISO 9409-1:2004	28
- Adapter kit DHAA	<ul style="list-style-type: none"> <li>• Drive/drive connections</li> <li>• Drive/gripper connections</li> </ul>	dhaa
- Slot nut NST	For mounting attachments	29
- Connecting shaft KSK	<ul style="list-style-type: none"> <li>• For torsion-resistant transmission of torques</li> <li>• For slip-free transmission of feed rates</li> <li>• To operate two cantilever axes in parallel using one motor</li> </ul>	29



## Type codes

001	Series
ELCC	Cantilever axis
002	Drive system
TB	Toothed belt
003	Guide
KF	Recirculating ball bearing guide
004	Size
60	60
70	70
90	90
110	110
005	Stroke
...	50 ... 2000
006	Stroke reserve
...	0 ... 999
007	Additional slide
	None
ZR	1 slide right
ZL	1 slide left
ZLC	1 slide on left, with clamping unit
ZRC	1 slide on right, with clamping unit

008	Protection against particles
P0	Without strip cover
P9	With cover strip
009	Additional characteristics
	None
F1	Food-safe according to supplementary information on materials
010	Material of toothed belt
CR	Chloroprene rubber
PU1	Uncoated PU, FDA-compliant
PU2	Coated PU
011	Displacement encoder
	None
M1	With displacement encoder, incremental, resolution 2.5 µm
012	Clamping unit
	None
C	Attached
013	Operating instructions
	With operating instructions
DN	No operating instructions

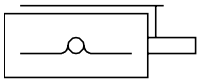
## Data sheet



-  Size  
60 ... 110
-  Stroke length  
50 ... 2000 mm



General technical data		60	70	90	110
Size		60	70	90	110
Design		Electromechanical cantilever axis			
Guide		Recirculating ball bearing guide			
Mounting position		Any			
Working stroke <sup>1)</sup>	[mm]	50 ... 1300	50 ... 1500	50 ... 2000	50 ... 2000
Max. feed force $F_x$	[N]	300	600	1200	2500
Max. no-load torque <sup>2)</sup>	[Nm]	0.6	1.2	2.5	4
Max. driving torque	[Nm]	5.2	10.4	33	90
Max. speed	[m/s]	5			
Max. acceleration	[m/s <sup>2</sup> ]	50		30	
Repetition accuracy	[mm]	±0.05			

1) Longer strokes on request

2) At 0.2 m/s

Operating and environmental conditions		
Ambient temperature <sup>1)</sup>	[°C]	-10 ... +60
Degree of protection		IP20
Duty cycle	[%]	100

1) Note operating range of proximity switches

Weights [g]		60	70	90	110
Size		60	70	90	110
Basic weight with 0 mm stroke					
ELCC-...		4146	7960	15713	27299
Mass of additional slide and clamping unit					
ELCC-...-ZL/ZR		1907	4316	6718	11713
ELCC-...-C		-	278	416	772
ELCC-...-P9		76	126	128	176
ELCC-...-M1		196	201	218	243
Moving mass with 0 mm stroke					
ELCC-...		1636	3210	5487	10017
ELCC-...-ZL/ZR (additionally)		1102	2306	3721	6936
Additional weight per 10 mm stroke					
ELCC-...		38	63	97	148

Toothed belt		60	70	90	110
Size		60	70	90	110
Pitch	[mm]	3	3	5	8
Elongation <sup>1)</sup>					
ELCC-...-CR	[%]	0.17	0.22	0.14	0.17
ELCC-...-PU1/PU2	[%]	0.07	0.08	0.06	-
Width	[mm]	30	50	75	100
Effective diameter	[mm]	30.558	30.558	50.93	68.755
Feed constant	[mm/rev.]	96	96	160	216

1) At max. feed force

## Data sheet

Mass moment of inertia		60	70	90	110
Size					
$J_0$	[kg mm <sup>2</sup> ]	594	1063	5518	15710
$J_H$ per metre stroke	[kg mm <sup>2</sup> /m]	887	1471	6290	17491
$J_L$ per kg payload	[kg mm <sup>2</sup> /kg]	233	233	648	1182

The mass moment of inertia  $J_A$  of the whole axis is calculated as follows:

## Basic version

$$J_A = J_0 + J_H \times l \text{ [m]} + J_L \times m_N \text{ [kg]}$$

## With gear unit

$$J_A = J_G + \frac{J_0 + J_H \cdot l \text{ [m]} + J_L \cdot m_N \text{ [kg]}}{i^2}$$

$J_G$  = Mass moment of inertia of the gear unit

$l$  = Working stroke

$m_N$  = Payload

## Materials

## Sectional view

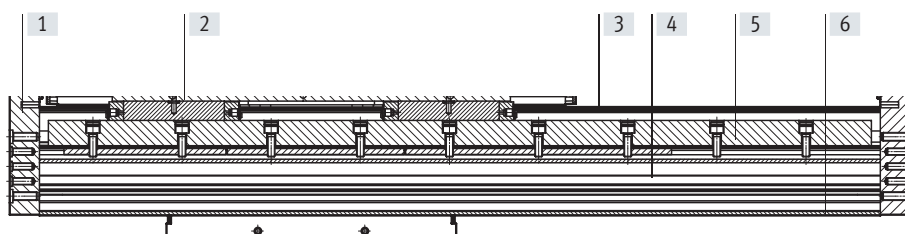

Axis Size	60	70	90	110
[1] End cap	Anodised wrought aluminium alloy			
[2] Drive head	Anodised wrought aluminium alloy			
[3] Cover strip	Stainless steel strip, non-corroding			
[4] Toothed belt				
ELCC-...-CR	Polychloroprene with glass cord and nylon coating			
ELCC-...-PU1	Polyurethane with steel cord (for food zone)			
ELCC-...-PU2	Polyurethane with steel cord and fabric coating			
[5] Guide rail	Rolled steel, corrotec coated			
[6] Profile	Anodised wrought aluminium alloy			
- Slide	Anodised cast aluminium			
Note on materials	RoHS-compliant Contains paint-wetting impairment substances			

Technical data – Displacement encoder system		60	70	90	110
Size					
Resolution	[μm]	2.5			
Max. travel speed with displacement encoder system	[m/s]	4			
Encoder signal		5 V TTL; A/A, B/B; reference signal (N/N) cyclical every 5 mm (zero pulse)			
Signal output		Line driver, alternating, resistant to sustained short circuit			
Electrical connection		8-pin plug, round design, M12			
Cable length	[mm]	160	160	45	25

Operating and environmental conditions – Displacement encoder system		
Ambient temperature	[°C]	-10 ... +70
Degree of protection		IP64
CE marking (see declaration of conformity)		To EU EMC Directive <sup>1)</sup>

1) For information about the area of use, see the EC declaration of conformity at: [www.festo.com/sp](http://www.festo.com/sp) → Certificates.

If the devices are subject to usage restrictions in residential, commercial or light-industrial environments, further measures for the reduction of the emitted interference may be necessary.



Data sheet

Technical data – Clamping unit			
Size	70	90	110
Pneumatic connection	M5		
Clamping type	Clamping via spring force, compressed air to release		
Static holding force [N]	450	550	850
Max. number of emergency braking operations <sup>1)</sup> at reference energy [J]	1000 30	1000 30	1000 30
Tried-and-tested component	To EN ISO 13849-1:2015-12		

1) Emergency braking refers to braking the payload if the drive axis loses power.

Operating and environmental conditions – Clamping unit	
Operating medium	Compressed air to ISO 8573-1:2010 [7:4:4]
Operating pressure [bar]	4 ... 6.5
Ambient temperature [°C]	-10 ... +60

Stroke reserve

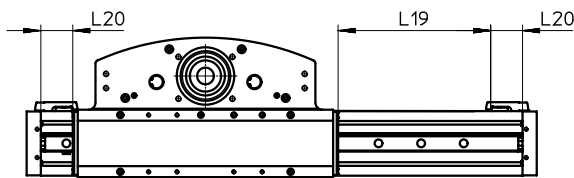

- L19 = Nominal stroke
- L20 = Stroke reserve
- The stroke reserve length can be freely selected
- The stroke reserve is defined via the "stroke reserve" characteristic in the modular product system.

Example:  
 Type ELCC-TB-KF-70-500-20H-...  
 Nominal stroke = 500 mm  
 2x 20 mm stroke reserve = 40 mm  
 Working stroke = 540 mm  
 (540 mm = 500 mm + 2x 20 mm)

Working stroke reduction

For axis ELCC with additional slide ZL/ZR

For a cantilever axis with additional slide, the working stroke is reduced by the length of the additional slide and the distance between the two slides

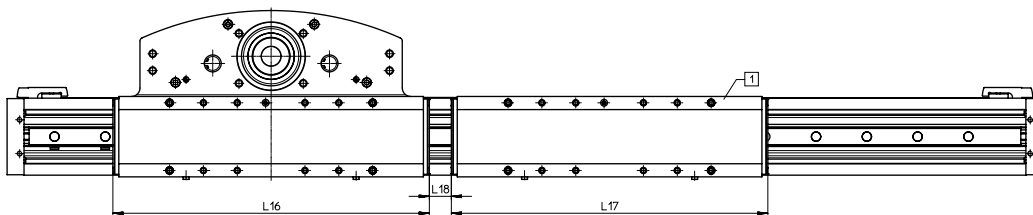

- L16 = Slide length
- L17 = Additional slide length
- L18 = Distance between the two slides
- [1] Additional slide

Example:  
 Type ELCC-TB-KF-70-1500-...-ZR  
 Working stroke without additional slide = 1500 mm  
 L18 = 50 mm  
 L17 = 356 mm  
 Working stroke with additional slide = 1094 mm  
 (1500 mm – 50 mm – 356 mm)

Dimensions – Additional slide				
Size	60	70	90	110
Length L17 [mm]	280	356	374	458
Min. distance between the slides L18				
ELCC-...-P0 [mm]	≥ 5	≥ 5	≥ 5	≥ 5
ELCC-...-P9 [mm]	≥ 50	≥ 50	≥ 50	≥ 50

## Data sheet

### Characteristic load values of the axis in slide operation

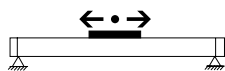

In slide operation, the profile is fixed and mounted in such a way that it does not sag.

The indicated forces and torques refer to the centre of the guide. The point of application of force is the point where the centre of the guide and the longitudinal centre of the slide intersect.

These values must not be exceeded during dynamic operation. Special attention must be paid to the deceleration phase.

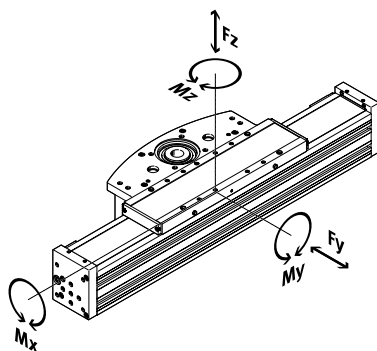

Distance from the slide surface to the centre of the guide

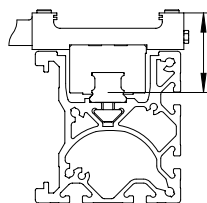

#### Distance from the slide surface to the centre of the guide

Size	60	70	90	110
Dimension x [mm]	29.9	39.1	43.8	54.0

#### Max. permissible forces and torques for a service life of 5000 km in slide operation

Size	60	70	90	110
F <sub>y</sub> max. [N]	4200	9600	13900	20600
F <sub>z</sub> max. [N]	4100	9400	13500	20000
M <sub>x</sub> max. [Nm]	35	105	165	315
M <sub>y</sub> max. [Nm]	290	825	1300	2365
M <sub>z</sub> max. [Nm]	285	795	1230	2285

#### Note

For a guide system to have a service life of 5000 km, the load comparison factor must have a value of  $f_v < 1$ , based on the maximum permissible forces and torques for a service life of 5000 km.

If the axis is subjected to two or more of the indicated forces and torques simultaneously, the following equation must be satisfied in addition to the indicated maximum loads:

Calculating the load comparison factor:

$$f_v = \frac{|F_{y1}|}{F_{y2}} + \frac{|F_{z1}|}{F_{z2}} + \frac{|M_{x1}|}{M_{x2}} + \frac{|M_{y1}|}{M_{y2}} + \frac{|M_{z1}|}{M_{z2}} \leq 1$$

F<sub>1</sub>/M<sub>1</sub> = dynamic value

F<sub>2</sub>/M<sub>2</sub> = maximum value

Data sheet

Characteristic load values of the axis in cantilever operation

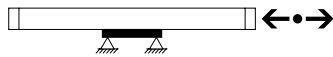

In cantilever operation, the axis is subjected to a higher load because of deflection. The torques are thus reduced in comparison to the slide operation. The indicated forces and torques refer to the centre of the guide. The point of application of force is the point where the centre of the guide and the longitudinal centre of the slide intersect. These values must not be exceeded during dynamic operation. Special attention must be paid to the deceleration phase.

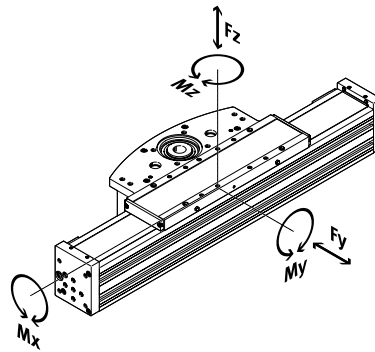

Distance from the slide surface to the centre of the guide

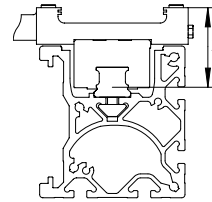

Axis position

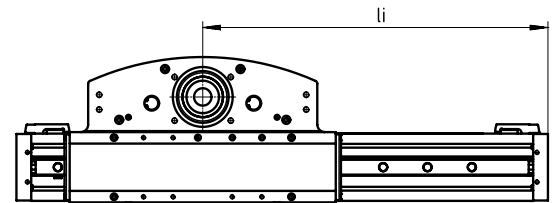

Distance from the slide surface to the centre of the guide

Size	60	70	90	110
Dimension x [mm]	29.9	39.1	43.8	54.0

Max. permissible forces and torques for a service life of 5000 km in cantilever operation

Size	60	70	90	110
Fy <sub>perm.</sub> [N]	4200	9600	13900	20600
Fz <sub>perm.</sub> [N]	4100	9400	13500	20000
Mx <sub>perm.</sub> [Nm]	20	50	75	180
My <sub>perm.</sub> [Nm]	110	240	350	885
Mz <sub>perm.</sub> [Nm]	90	190	295	615

Step 1:

Calculating the load comparison factor f<sub>vi</sub> for the different axis positions l<sub>i</sub>

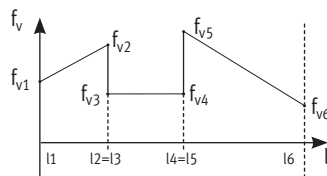

$$f_{vi} = \frac{|F_{y1}|}{F_{y2}} + \frac{|F_{z1}|}{F_{z2}} + \frac{|M_{x1}|}{M_{x2}} + \frac{|M_{y1}|}{M_{y2}} + \frac{|M_{z1}|}{M_{z2}}$$

$$f_{vi} = f_{v1}, f_{v2}, f_{v3}, f_{v4}, f_{v5}, f_{v6}$$

If all f<sub>vi</sub> ≤ 1, it can be assumed, for the purpose of simplicity, that: Total load comparison factor f<sub>vG</sub> corresponds to the largest f<sub>vi</sub> and steps 2-3 can be omitted.

If any f<sub>vi</sub> > 1, the precise total load comparison factor f<sub>vG</sub> should be calculated using steps 2 and 3.

Step 2:

Calculating the substitute load comparison factors for the different partial strokes f<sub>vEi</sub>

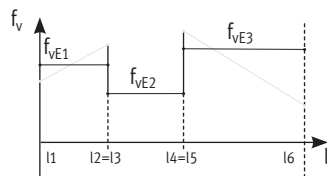

$$f_{vEi} = \sqrt[3]{\frac{(f_{vi} + f_{vi+1}) \cdot (f_{vi}^2 + f_{vi+1}^2)}{4}}$$

$$f_{vEi} = f_{vE1}, f_{vE2}, f_{vE3}$$

f<sub>vEi</sub> = Substitute load comparison factor for partial stroke 1

l<sub>1</sub> to l<sub>2</sub> = Partial stroke 1

Step 3:

Calculating the load comparison factor f<sub>vG</sub> for the total stroke

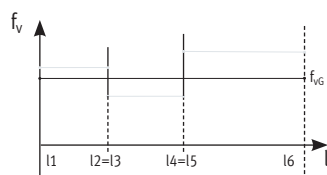

$$f_{vG} = \sqrt[3]{\sum \frac{f_{vEi}^3 \cdot (l_{i+1} - l_i)}{l_{ges}}}$$

f<sub>vG</sub> = Load comparison factor for the total stroke

Step 4:

Calculating the service life

$$L = \frac{5000 \text{ km}}{f_{vG}^3}$$

## Data sheet

## Calculating the service life

The service life of the guide depends on the load. To be able to make a statement as to the service life of the guide, the graph below plots the total load comparison factor  $f_{VG}$  against the service life.

These values are only theoretical. You must consult your local Festo contact for a total load comparison factor  $f_{VG}$  greater than 1.5.

Total load comparison factors  $f_{VG}$  as a function of service life

Example:

A user wants to move an X kg load. Using the formula (→ page 10/11) gives a value of 1.5 for the total load comparison factor  $f_{VG}$ . According to the graph, the guide has a service life of approx. 1500 km.

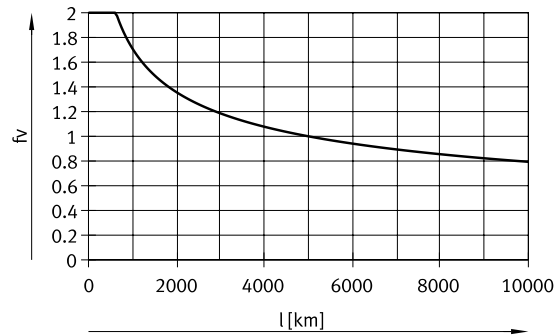

**Note**  
Engineering software  
Electric Motion Sizing  
[www.festo.com/x/electric-motion-sizing](http://www.festo.com/x/electric-motion-sizing)

The software can be used to calculate a guide workload for a service life of 5000 km.

## Comparison of the characteristic load values for 5000 km with dynamic forces and torques of recirculating ball bearing guides

The characteristic load values of bearing guides are standardised to ISO and JIS using dynamic and static forces and torques. These forces and torques are based on an expected service life of the guide system of 100 km according to ISO or 50 km according to JIS.

As the characteristic load values are dependent on the service life, the maximum permissible forces and torques for a 5000 km service life cannot be compared with the dynamic forces and torques of bearing guides to ISO/JIS.

To make it easier to compare the guide capacity of cantilever axes ELCC with bearing guides, the table below lists the theoretically permissible forces and torques for a calculated service life of 100 km. This corresponds to the dynamic forces and torques to ISO.

These 100 km values have been calculated mathematically and are only to be used for comparing with dynamic forces and torques to ISO. The drives must not be loaded with these characteristic values as this could damage the axes.

## Max. permissible forces and torques for a theoretical service life of 100 km (from a guide perspective only)

Size		60	70	90	110
$F_{Y_{max}}$	[N]	17101	39712	57255	84489
$F_{Z_{max}}$	[N]	16410	37901	54354	80725
$M_{X_{max}}$	[Nm]	138	401	643	1221
$M_{Y_{max}}$	[Nm]	1126	3138	4838	8982
$M_{Z_{max}}$	[Nm]	1086	2954	4548	8488

Data sheet

Speed v as a function of rotational speed n

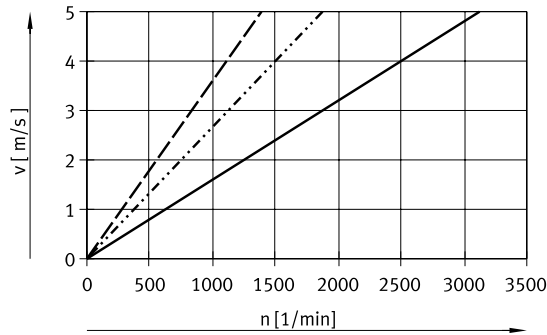

- ELCC-TB-KF-60/70
- ELCC-TB-KF-90
- - - ELCC-TB-KF-110

Theoretical feed force F as a function of input torque M

Size 6 0/70

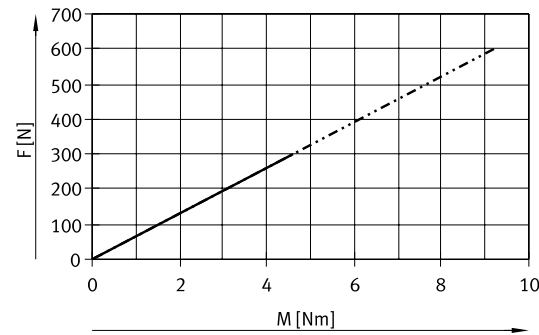

- ELCC-TB-KF-60
- ELCC-TB-KF-70

Size 9 0/110

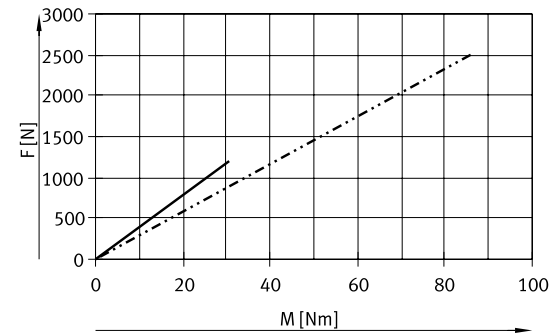

- ELCC-TB-KF-90
- ELCC-TB-KF-110

Second moment of area

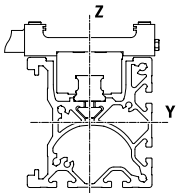

Size		60	70	90	110
$I_y$	[mm <sup>4</sup> ]	$240.60 \times 10^3$	$959.74 \times 10^3$	$2.67 \times 10^6$	$6.83 \times 10^6$
$I_z$	[mm <sup>4</sup> ]	$304.21 \times 10^3$	$928.74 \times 10^3$	$2.05 \times 10^6$	$4.93 \times 10^6$

Data sheet

Deflection  $f$  as a function of the cantilever extension  $A$  and the payload  $m$

Interface for drive head [1], horizontal

Interface for drive head [1], vertical

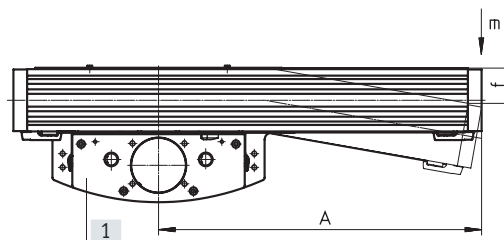
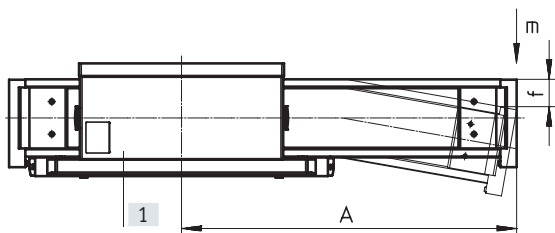

Size 60

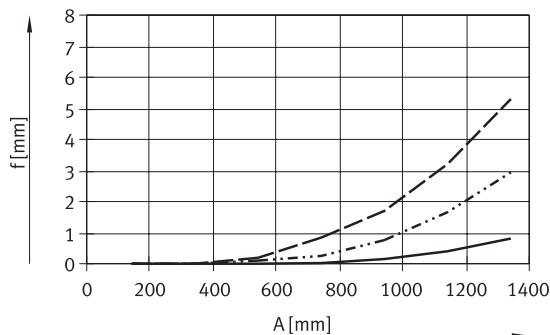
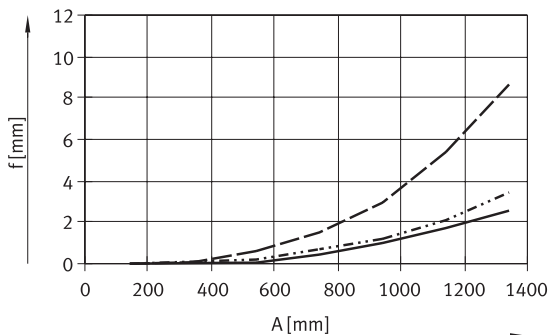

- $m = 0$  kg
- ⋯  $m = 5$  kg
- -  $m = 10$  kg

- $m = 0$  kg
- ⋯  $m = 5$  kg
- -  $m = 10$  kg

Size 70

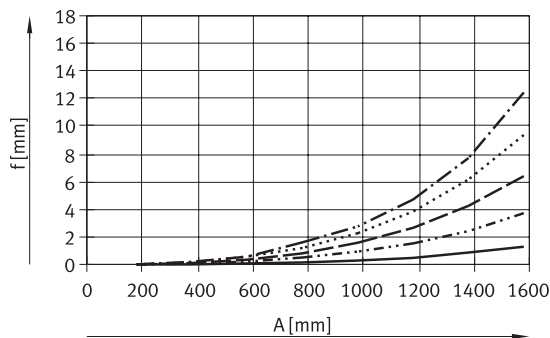
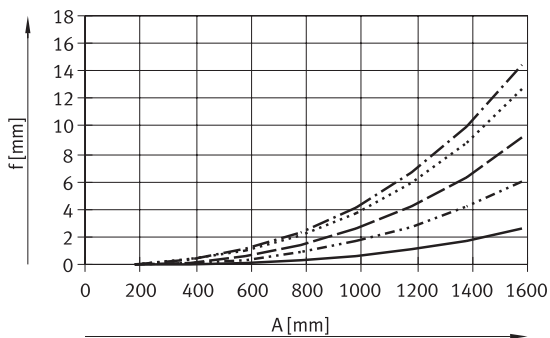

- $m = 0$  kg
- ⋯  $m = 10$  kg
- -  $m = 20$  kg
- · -  $m = 30$  kg
- - -  $m = 35$  kg

- $m = 0$  kg
- ⋯  $m = 10$  kg
- -  $m = 20$  kg
- · -  $m = 30$  kg
- - -  $m = 35$  kg

Data sheet

Deflection  $f$  as a function of the cantilever extension  $A$  and the payload  $m$

Interface for drive head [1], horizontal

Interface for drive head [1], vertical

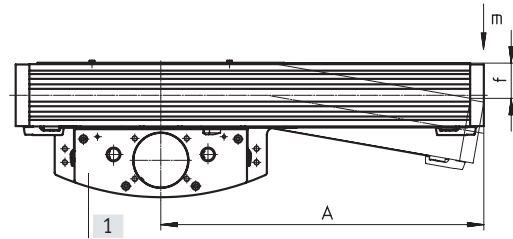
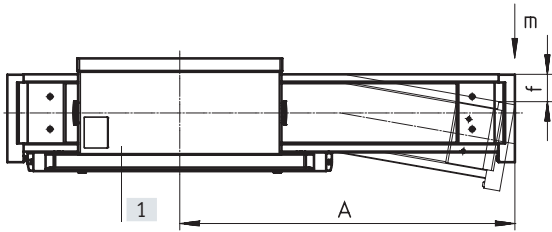

Size 90

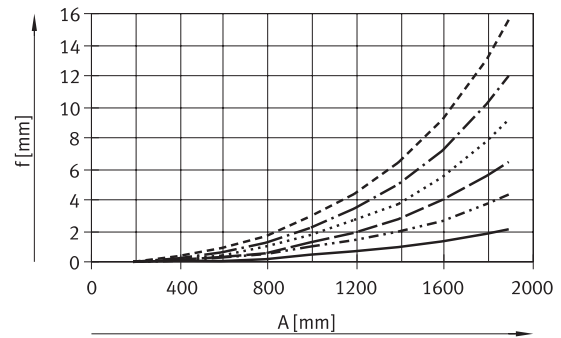
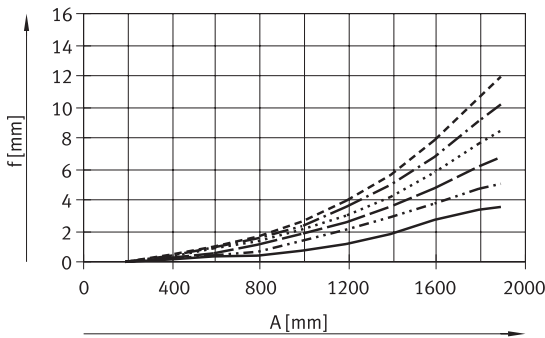

- $m = 0$  kg
- · - ·  $m = 10$  kg
- - -  $m = 20$  kg
- · · ·  $m = 30$  kg
- · - ·  $m = 40$  kg
- - -  $m = 50$  kg

- $m = 0$  kg
- · - ·  $m = 10$  kg
- - -  $m = 20$  kg
- · · ·  $m = 30$  kg
- · - ·  $m = 40$  kg
- - -  $m = 50$  kg

Size 110

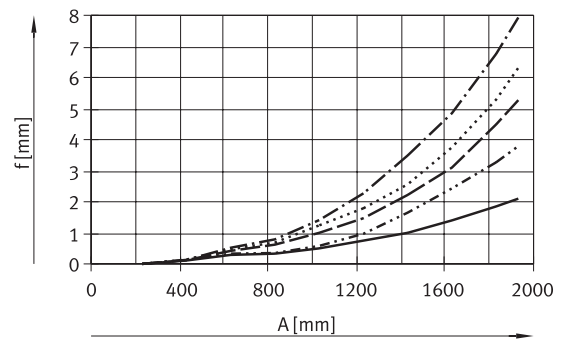
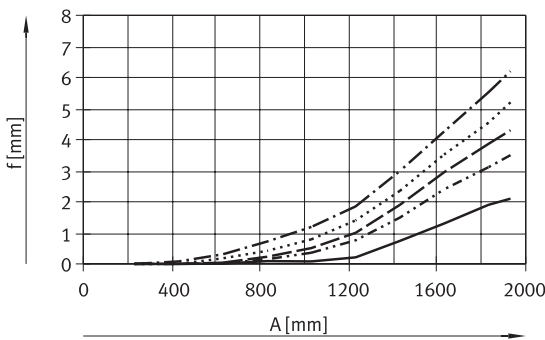

- $m = 0$  kg
- · - ·  $m = 20$  kg
- - -  $m = 30$  kg
- · · ·  $m = 40$  kg
- · - ·  $m = 50$  kg

- $m = 0$  kg
- · - ·  $m = 20$  kg
- - -  $m = 30$  kg
- · · ·  $m = 40$  kg
- · - ·  $m = 50$  kg

Data sheet

Dimensions

Download CAD data → [www.festo.com](http://www.festo.com)

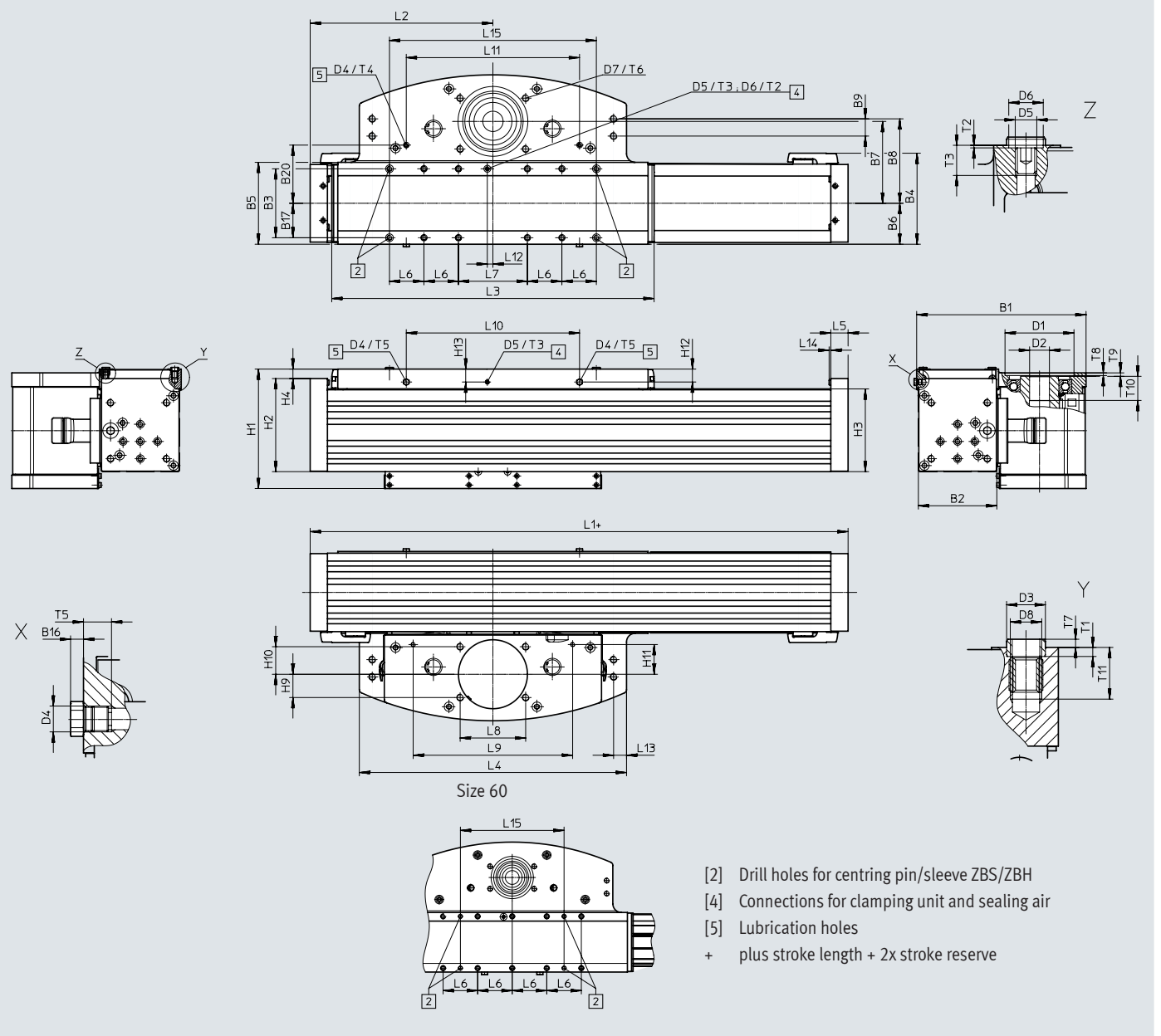

Size	B1	B2	B3	B4	B5	B6	B7	B8	B9	B16	B17
60	150.5	59.5	60	77.1	69	34.5	75	71.5	15	3	29.5
70	167.5	73	78	94.1	90	45	81.5	81.5	16	3	39
90	196.5	91	80	105.6	95	47.5	95	98	20	3	40
110	247.5	113	100	130.3	117	58.5	120	112	20	3	50

Size	B20	D1	D2	D3	D4	D5	D6	D7	D8	H1	H2
		∅	∅	∅			∅				
		H7	H7	H7			H7				
60	-	48	16	5	M6	M5	8	M6	M5	78.6	58
70	53	48	16	9	M6	M5	8	M6	M5	112	86
90	67.5	80	23	9	M6	M5	8	M8	M6	138.6	108
110	66	95	32	12	M6	M5	8	M8	M8	170.6	136.5



## Data sheet

Size	H3	H4	H9	H10	H11	H12	H13	L1	L2 Min.	L3	L4
60	47	9	13	13	29	14.3	13	330	165	280	233
70	73	11	13	13	29	16	16	406	203	356	253
90	95	11	27	32	34.5	15	15	424	212	374	310
110	120	14.5	40	40	48.5	22	22	508	254	458	358

Size	L5	L6	L7	L8	L9	L10	L11	L12	L13	L14	L15
60	20	40	–	51	120	64	–	10	7	2	120
70	20	40	70	51	120	187	187	5.5	12	2	230
90	20	40	80	76	185	201	201	6.5	15	2	240
110	20	40	120	80	210	248	248	14.2	15	2	280

Size	T1	T2	T3	T4	T5	T6	T7	T8	T9	T10	T11
60	2.5	0.6	7	–	6.5	12	2.5	2.1	4	26	10
70	2.1	0.6	7	6.1	6.5	12	1.9	2.1	4	26	10
90	2.1	0.6	7	6.5	6.5	16	1.9	3.1	4	28	12
110	2.6	0.6	7	6.5	6.5	17	2.4	2.8	4	33	16.2

Data sheet

**Dimensions**

Download CAD data → [www.festo.com](http://www.festo.com)

Profile

Size 60

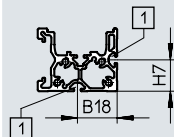

Size 70

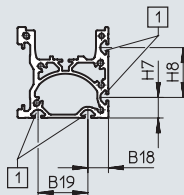

Size 90

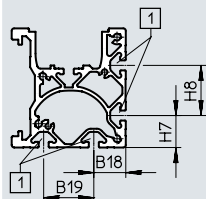

Size 110

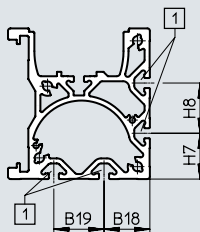

[1] Mounting slot for slot nut

Size	H7	H8	B18	B19
60	23.5	-	29.75	-
70	16.5	40	16.5	40
90	25.5	40	25.5	40
110	36.5	40	36.5	40

Data sheet

Dimensions

Download CAD data → [www.festo.com](http://www.festo.com)

Interface on front end for mounting the payload

Size 60

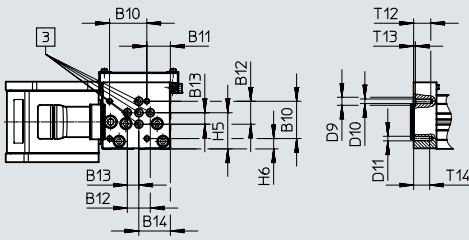

Size 70

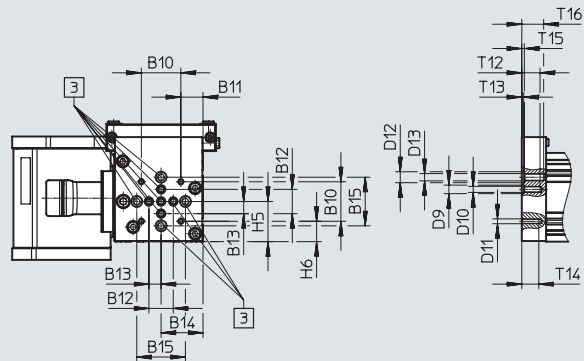

Size 90

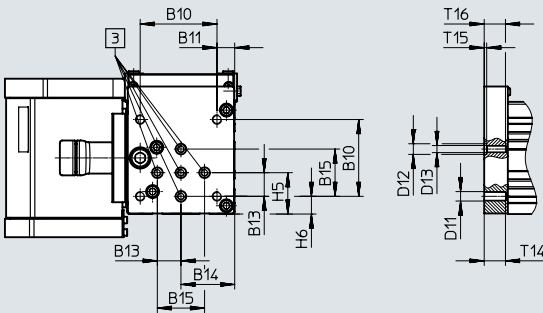

Size 110

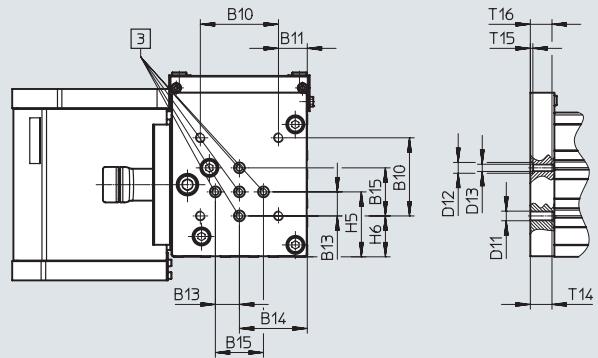

[3] Mounting slot for slot nut

Size	B10	B11	B12	B13	B14	B15	D9 ∅ H7	D10	D11
60	32.5	20.5	20	10	27.5	-	7	M4	M4
70	32.5	18.3	20	10	34.5	40	7	M5	M4
90	65	15	-	20	45.5	40	-	-	M8
110	65	24	-	20	56.5	40	-	-	M8

Size	D12 ∅ H7	D13	H5	H6	T12	T13	T14	T15	T16
60	-	-	31.5	9	15	1.6	14	-	-
70	9	M6	33	16.75	15	1.6	14	2.1	18
90	9	M6	35	15	-	-	18	2.1	18
110	9	M6	54	34	-	-	18	2.1	18

## Data sheet

### Dimensions

Download CAD data → [www.festo.com](http://www.festo.com)

ELCC-TB-KF-60/70-...-M1 – with incremental displacement encoder system

Encoder cable  
(connection to motor controller/safety system  
→ page 30)

Size	B1	B2	B3	B4	B5	H1	H2	H3
60	32.6	26.8	15	14.1	10	30.5	19.1	30.5
70	23.6	19.3	7.5	14.1	10	27.3	18.3	30.5

Size	H4	H5	H6	L1	L2	L3	L4	L5	L6
60	4.5	1.8	1	86	82	72	81	72	47
70	4.5	1.8	1	86	82	72	81	72	47

ELCC-TB-KF-90/110-...-M1 – with incremental displacement encoder system

Encoder cable  
(connection to motor controller/safety system  
→ page 30)

Size	L1
90	79
110	79

## Data sheet

## Ordering data – Standard version

## Key features:

- Stroke reserve: 0 mm
- Without cover strip
- Toothed belt material: Chloroprene rubber

Size	Stroke [mm]	Part no.	Type
60	200	8082386	ELCC-TB-KF-60-200-0H-P0-CR
	300	8082387	ELCC-TB-KF-60-300-0H-P0-CR
	500	8082388	ELCC-TB-KF-60-500-0H-P0-CR
	600	8082389	ELCC-TB-KF-60-600-0H-P0-CR
	800	8082390	ELCC-TB-KF-60-800-0H-P0-CR
	1000	8082391	ELCC-TB-KF-60-1000-0H-P0-CR
70	200	8082392	ELCC-TB-KF-70-200-0H-P0-CR
	300	8082393	ELCC-TB-KF-70-300-0H-P0-CR
	500	8082394	ELCC-TB-KF-70-500-0H-P0-CR
	600	8082395	ELCC-TB-KF-70-600-0H-P0-CR
	800	8082396	ELCC-TB-KF-70-800-0H-P0-CR
	1000	8082397	ELCC-TB-KF-70-1000-0H-P0-CR
	1200	8082398	ELCC-TB-KF-70-1200-0H-P0-CR
90	200	8082399	ELCC-TB-KF-90-200-0H-P0-CR
	300	8082400	ELCC-TB-KF-90-300-0H-P0-CR
	500	8082401	ELCC-TB-KF-90-500-0H-P0-CR
	600	8082402	ELCC-TB-KF-90-600-0H-P0-CR
	800	8082403	ELCC-TB-KF-90-800-0H-P0-CR
	1000	8082404	ELCC-TB-KF-90-1000-0H-P0-CR
	1200	8082405	ELCC-TB-KF-90-1200-0H-P0-CR
	1500	8082406	ELCC-TB-KF-90-1500-0H-P0-CR
	1700	8082407	ELCC-TB-KF-90-1700-0H-P0-CR
	2000	8082408	ELCC-TB-KF-90-2000-0H-P0-CR
110	200	8082409	ELCC-TB-KF-110-200-0H-P0-CR
	300	8082410	ELCC-TB-KF-110-300-0H-P0-CR
	500	8082411	ELCC-TB-KF-110-500-0H-P0-CR
	600	8082412	ELCC-TB-KF-110-600-0H-P0-CR
	800	8082413	ELCC-TB-KF-110-800-0H-P0-CR
	1000	8082414	ELCC-TB-KF-110-1000-0H-P0-CR
	1200	8082415	ELCC-TB-KF-110-1200-0H-P0-CR
	1500	8082416	ELCC-TB-KF-110-1500-0H-P0-CR
	1700	8082417	ELCC-TB-KF-110-1700-0H-P0-CR
	2000	8082418	ELCC-TB-KF-110-2000-0H-P0-CR

## Ordering data – Modular product system

### Orientation guide

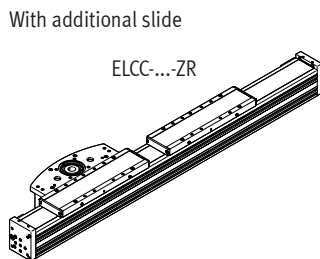
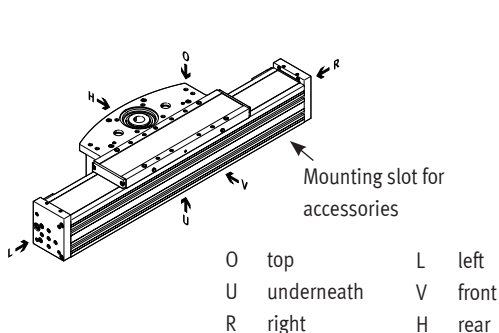

Ordering table		60	70	90	110	Conditions	Code	Enter code
Module no.		<b>8060571</b>	<b>8060572</b>	<b>8060573</b>	<b>8060574</b>			
Function		Cantilever axis					<b>ELCC</b>	ELCC
Drive system		Toothed belt					<b>-TB</b>	-TB
Guide		Recirculating ball bearing guide					<b>-KF</b>	-KF
Size		60	70	90	110		-...	
Stroke	Standard [mm]	200, 300, 500, 600, 800, 1000	200, 300, 500, 600, 800, 1000, 1200	200, 300, 500, 600, 800, 1000, 1200, 1500, 1700, 2000	200, 300, 500, 600, 800, 1000, 1200, 1500, 1700, 2000		-...	
	Variable [mm]	50 ... 1300	50 ... 1500	50 ... 2000	50 ... 2000		-...	
Stroke reserve	[mm]	0 ... 999 (0 = no stroke reserve)				[1]	<b>-...H</b>	
Additional slide		None						
		Slide on left				[2]	<b>-ZL</b>	
		Slide on right				[2]	<b>-ZR</b>	
		-	Slide on left, with clamping unit		[2]	<b>-ZLC</b>		
		-	Slide on right, with clamping unit		[2]	<b>-ZRC</b>		
Protection against particles		Without cover strip					<b>-P0</b>	
		With cover strip					<b>-P9</b>	
Additional features		None						
		Food-safe as per supplementary material information				[3]	<b>-F1</b>	
Material of toothed belt		Chloroprene rubber					<b>-CR</b>	
		Uncoated PU for the food zone			-		<b>-PU1</b>	
		PU-coated			-		<b>-PU2</b>	
Displacement encoder, incremental		None						
		Resolution 2.5 µm					<b>-M1</b>	
Clamping unit		None						
		-	Attached				<b>-C</b>	
Operating instructions		With operating instructions						
		Without operating instructions					<b>-DN</b>	

[1] ...H The sum of nominal reserve and 2x stroke reserve must not exceed the maximum stroke length

[2] ZL, ZR, ZLC, ZRC Reduction in working stroke in combination with additional slide → page 15

[3] F1 Select corresponding material for toothed belt in combination with feature F1

Accessories

 **Note**  
 For the optimum selection of axis/  
 motor combinations → Engineering software  
 PositioningDrives  
[www.festo.com](http://www.festo.com)

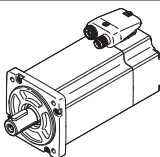
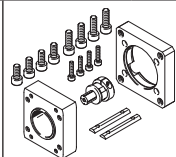
Permissible axis/motor combinations with axial kit			
Motor/gear unit <sup>1)</sup>	Axial kit		
			• Kits for third-party motors → Internet: eamm-a
Type	Part no.	Type	Data sheets → Internet: eamm-a
<b>ELCC-TB-KF-60</b>			
<b>With servo motor</b>			
EMME-AS-80-...	8063592	EAMM-A-N48-80P	
<b>With servo motor and gear unit</b>			
EMMT-AS-60-..., EMME-AS-60-... EMGA-60-P-...-EAS-60	1456618	EAMM-A-N48-60H	
EMMT-AS-80-..., EMME-AS-80-... EMGA-80-P-...-EAS-80	1258793	EAMM-A-N48-80G	
<b>With servo motor and right-angle gear unit</b>			
EMMT-AS-60-..., EMME-AS-60-... EMGA-60-A-...-60P	1456618	EAMM-A-N48-60H	
EMMT-AS-80-..., EMME-AS-80-... EMGA-80-A-...-80P	1258793	EAMM-A-N48-80G	
<b>ELCC-TB-KF-70</b>			
<b>With servo motor</b>			
EMMT-AS-100-..., EMME-AS-100-...	1201894	EAMM-A-N48-100A	
<b>With servo motor and gear unit</b>			
EMMT-AS-80-..., EMME-AS-80-... EMGA-80-P-...-EAS-80	1258793	EAMM-A-N48-80G	
EMMT-AS-100-..., EMME-AS-100-... EMGA-80-P-...-SAS-100	1258793	EAMM-A-N48-80G	
<b>With servo motor and right-angle gear unit</b>			
EMMT-AS-80-..., EMME-AS-80-... EMGA-80-A-...-80P	1258793	EAMM-A-N48-80G	

1) The input torque must not exceed the max. permissible transferable torque of the axial kit.

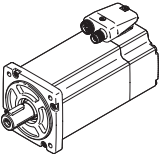
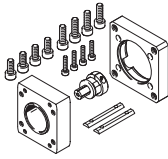

## Accessories

Permissible axis/motor combinations with axial kit			
Motor/gear unit <sup>1)</sup>	Axial kit		
	 <ul style="list-style-type: none"> <li>• Kits for third-party motors → Internet: eamm-a</li> </ul>		
Type	Part no.	Type	Data sheets → Internet: eamm-a
<b>ELCC-TB-KF-90</b>			
<b>With servo motor</b>			
EMMT-AS-100-..., EMME-AS-100-...	8063607	EAMM-A-N80-100A	
EMMT-AS-150-...	8157277	EAMM-A-N80-150A	
<b>With servo motor and gear unit</b>			
EMMT-AS-100-..., EMME-AS-100-... EMGA-80-P-...-SAS-100	2372096	EAMM-A-N80-80G	
<b>With servo motor and right-angle gear unit</b>			
EMMT-AS-100-..., EMME-AS-100-... EMGA-80-A-...-100A	2372096	EAMM-A-N80-80G	
<b>ELCC-TB-KF-110</b>			
<b>With servo motor and gear unit</b>			
EMMT-AS-100-..., EMME-AS-100-... EMGA-80-P-...-SAS-100	3660191	EAMM-A-L95-80G-G2	
<b>With servo motor and right-angle gear unit</b>			
EMMT-AS-100-..., EMME-AS-100-... EMGA-80-A-...-100A	3660191	EAMM-A-L95-80G-G2	

1) The input torque must not exceed the max. permissible transferable torque of the axial kit.

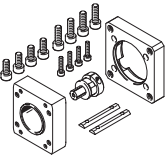
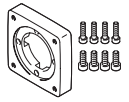
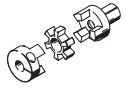

## Accessories

Part components of the axial kit				
Axial kit	Comprising:			
	Motor flange	Coupling	Coupling housing	Screw set
				
Part no. Type	Part no. Type	Part no. Type	Part no. Type	Part no. Type
<b>ELCC-TB-KF-60</b>				
8063592 EAMM-A-N48-80P	–	558002 EAMD-42-40-19-16X25	5204317 EAMK-A-N48-80P	–
1456618 EAMM-A-N48-60H	1460111 EAMF-A-48C-60G/H	1377840 EAMD-32-32-14-16X20	1345949 EAMK-A-N48-48C	4984529 EAHM-L5-M6-45
1258793 EAMM-A-N48-80G	1190375 EAMF-A-48C-80G	1781043 EAMD-42-40-20-16X25-U	1345949 EAMK-A-N48-48C	1201874 EAHM-L5-M6-50
<b>ELCC-TB-KF-70</b>				
1201894 EAMM-A-N48-100A	1201924 EAMF-A-48C-100A	558002 EAMD-42-40-19-16X25	1345949 EAMK-A-N48-48C	1201874 EAHM-L5-M6-50
1258793 EAMM-A-N48-80G	1190375 EAMF-A-48C-80G	1781043 EAMD-42-40-20-16X25-U	1345949 EAMK-A-N48-48C	1201874 EAHM-L5-M6-50
<b>ELCC-TB-KF-90</b>				
1201691 EAMM-A-N80-140A	1190796 EAMF-A-80A-140A	558005 EAMD-56-46-24-23X27	1345953 EAMK-A-N80-80A	1201751 EAHM-L5-M8-75
2372096 EAMM-A-N80-80G	2372201 EAMF-A-80A-80G	558004 EAMD-56-46-20-23X27	1345953 EAMK-A-N80-80A	1201712 EAHM-L5-M8-60
<b>ELCC-TB-KF-110</b>				
3660191 EAMM-A-L95-80G-G2	3305700 EAMF-A-95B-80G	3717812 EAMD-67-51-20-32X32-U	3712650 EAMK-A-L95-95A/B-G2	–
3659941 EAMM-A-L95-120G-G2	3659724 EAMF-A-95A-120G-G2	558006 EAMD-67-51-25-32X32-U	3712650 EAMK-A-L95-95A/B-G2	567496 EAHM-L2-M8-70

Accessories

**Switch lug DASI-E21-SL**

For position sensing using a proximity switch SIEN-8MB

Material:  
Galvanised steel  
RoHS-compliant

**Sensor bracket DASI-E21-SR**

For proximity switch SIEN-8MB

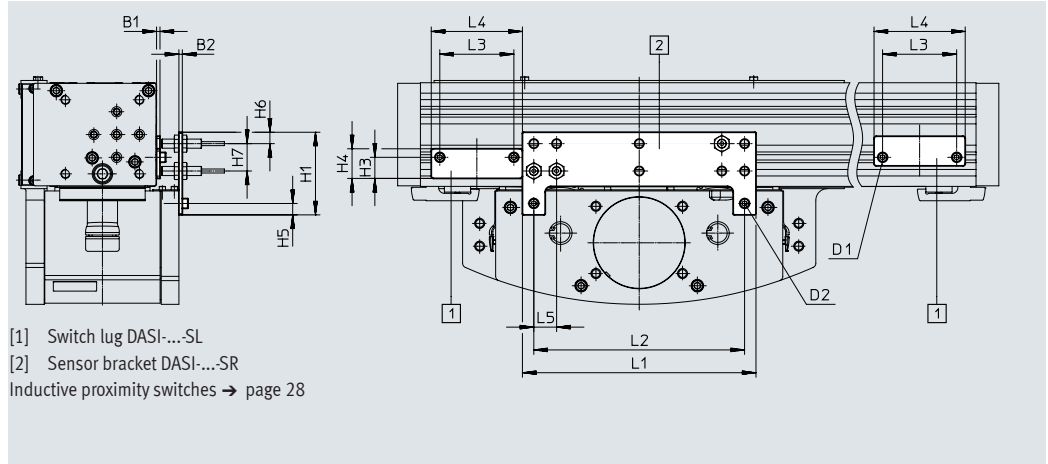
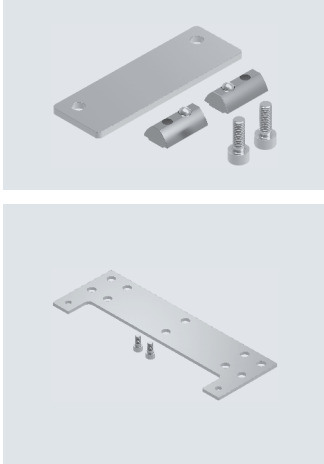

[1] Switch lug DASI-...-SL  
[2] Sensor bracket DASI-...-SR  
Inductive proximity switches → page 28

**Dimensions and ordering data**

For size	B1	B2	D1	D2	H1	H3	H4	H5
60	3	3	M4	M5	77.8	19	24	10
70	3	3	M4	M5	101.5	16	21	10
90	3	3	M5	M5	72.5	18.5	26	10
110	3	3	M5	M5	83.5	18.5	26	10

For size	H6	H7	L1	L2	L3	L4	L5
60	10	28	140	120	50	60	20
70	10	22	140	120	50	60	20
90	10	24	205	185	65	80	20
110	10	24	230	210	65	80	20

**Switch lug**

For size	Weight [g]	Part no.	Type	PE <sup>1)</sup>
60	40	8081324	DASI-E21-60-S8-SL	1
70	36	8081063	DASI-E21-70-S8-SL	
90	77	8081061	DASI-E21-90/110-S8-SL	
110	77	8081061	DASI-E21-90/110-S8-SL	

**Sensor bracket**

For size	Weight [g]	Part no.	Type	PE <sup>1)</sup>
60	132	8081066	DASI-E21-60-S8-SR	1
70	225	8081064	DASI-E21-70-S8-SR	
90	247	8081060	DASI-E21-90-S8-SR	
110	326	8081062	DASI-E21-110-S8-SR	

1) Packaging unit

Accessories

Shock absorber retainer DAYP-E21

Material:  
Retainer, stop: Anodised wrought aluminium alloy  
RoHS-compliant

 **Note**  
The additional length of the profile required for the installation space must be taken into account when ordering the axis (stroke specification).

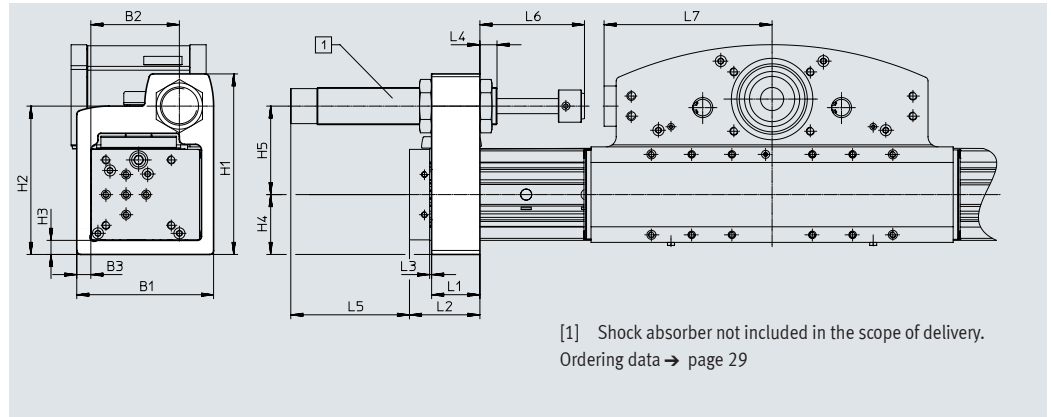

[1] Shock absorber not included in the scope of delivery.  
Ordering data → page 29

Dimensions and ordering data

For size	B1	B2	B3	H1	H2	H3	H4	H5	L1	L2
60	78	46	10	120.5	101.5	10	37.5	64	28	50
70	106	70	10	143.5	118	10	44.5	73.5	32	54
90	136	88	14	179.5	147.5	14	59.5	88	48	70
110	178	113	20	218.5	178.5	20	76.5	102	48	70

For size	L3 Min.	L4 Min.	L5	L6 Min.	L7	Weight [g]	Part no.	Type	PE <sup>1)</sup>
60	2	13	41	58.5	126.5	356	8067058	DAYP-E21-60	1
70	2	23	75	84.5	138.5	586	8067060	DAYP-E21-70	
90	2	17	118	104	167	1552	8067062	DAYP-E21-90	
110	2	17	118	104	191	2323	8067064	DAYP-E21-110	

1) Packaging unit

Accessories

**Adapter kit DHAA-R**

For interface to ISO 9409-1:2004

Material:

Adapter plate: Wrought aluminium alloy

Screws: Galvanised steel

RoHS-compliant

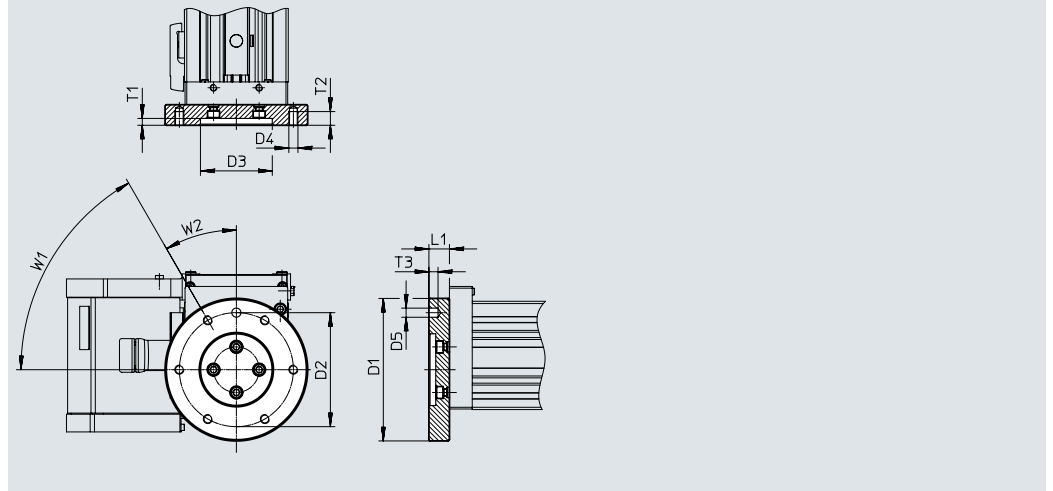
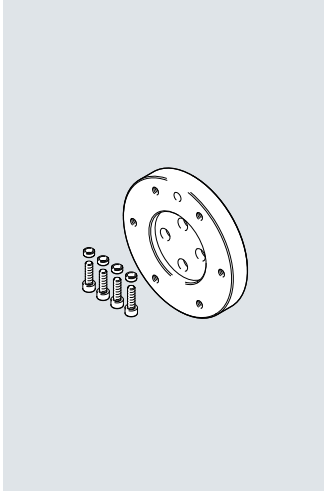







**Dimensions and ordering data**

For size	D1 ∅ h8	D2 ∅	D3 ∅ H7	D4	D5 ∅ H7	L1	T1
70	125	100	63	M8	8	18	6
90							
110							

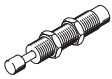
For size	T2	T3	W1	W2	Weight [g]	Part no.	Type	PE <sup>1)</sup>
70	12	8	60°	30°	559	8082459	DHAA-R-E21-70...110RF1-100	1
90								
110								





1) Packaging unit



## Accessories

Ordering data		For size	Description	Part no.	Type	PE <sup>1)</sup>
<b>Shock absorber YSR</b>						
	60	For use in combination with shock absorber retainer DAYP-E21		34574	YSR-20-25-C	1
	70			160273	YSR-25-40-C	
	90, 110			160274	YSR-32-60-C	
<b>Slot nut NST</b>						
	60, 70	For profile slot		150914	NST-5-M5	1
				8047843	NST-5-M5-10	10
				8047878	NST-5-M5-50	50
	90, 110	For profile slot		150915	NST-8-M6	1
				8047868	NST-8-M6-10	10
8047869	NST-8-M6-50	50				
<b>Centring pin/sleeve ZBS/ZBH</b>						
	60	For mounting the drive head		150928	ZBS-5	10
	70, 90			8137184	ZBH-9-B	
	110			8137185	ZBH-12-B	
	60, 70	For centring on the front end		8146544	ZBH-7-B	
	70, 90, 110			8137184	ZBH-9-B	
<b>Slot cover ABP</b>						
	60, 70	• For mounting slot • Every 0.5 m		151681	ABP-5	2
	90, 110			151682	ABP-8	
<b>Drive shaft EAMB</b>						
	60, 70	• Can, if required, be used as an alternative interface • No drive shaft is required for the axis/motor combinations → page 25		558036	EAMB-24-6-15X21-16X20	1
	90			558037	EAMB-34-6-25X26-23X27	
	110			558038	EAMB-44-7-35X30-32X32	
<b>Clamping component EADT</b>						
	60	Tool for retensioning the cover strip		8058451	EADT-S-L5-70	1
	70, 90			8097157	EADT-S-L5-90	
	110			8058450	EADT-S-L5-120	
<b>Connecting shaft KSK</b>						
	60, 70	• For torsion-resistant transmission of torques • For slip-free transmission of feed rates • To operate two cantilever axes in parallel using one motor		562521	KSK-80-	1
	90			562522	KSK-120-	
	110			562523	KSK-185-	

1) Packaging unit

## Accessories

Ordering data – Proximity switches M8 (round design), inductive						Data sheets → Internet: sien
	Electrical connection	LED	Switching output	Cable length [m]	Part no.	Type
<b>N/O contact</b>						
	Cable, 3-wire	■	PNP	2.5	150386	SIEN-M8B-PS-K-L
			NPN	2.5	150384	SIEN-M8B-NS-K-L
	Plug M8x1, 3-pin	■	PNP	–	150387	SIEN-M8B-PS-S-L
			NPN	–	150385	SIEN-M8B-NS-S-L
<b>N/C contact</b>						
	Cable, 3-wire	■	PNP	2.5	150390	SIEN-M8B-PO-K-L
			NPN	2.5	150388	SIEN-M8B-NO-K-L
	Plug M8x1, 3-pin	■	PNP	–	150391	SIEN-M8B-PO-S-L
			NPN	–	150389	SIEN-M8B-NO-S-L

Ordering data – Connecting cables					Data sheets → Internet: nebu
	Electrical connection, left	Electrical connection, right	Cable length [m]	Part no.	Type
	Straight socket, M8x1, 3-pin	Cable, open end, 3-wire	2.5	159420	SIM-M8-3GD-2,5-PU
			2.5	541333	NEBU-M8G3-K-2.5-LE3
			5	541334	NEBU-M8G3-K-5-LE3
	Angled socket, M8x1, 3-pin	Cable, open end, 3-wire	2.5	541338	NEBU-M8W3-K-2.5-LE3
			5	541341	NEBU-M8W3-K-5-LE3

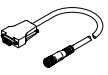
Ordering data – Encoder cables for displacement encoder system, ELCC-...-M1					Data sheets → Internet: nebm
	Electrical connection, left	Electrical connection, right	Cable length [m]	Part no.	Type
	Displacement encoder system ELCC-...-M1	Motor controller CMMP-AS	5	1599105	NEBM-M12G8-E-5-S1G9-V3
			10	1599106	NEBM-M12G8-E-10-S1G9-V3
			15	1599107	NEBM-M12G8-E-15-S1G9-V3
			X <sup>1)</sup>	1599108	NEBM-M12G8-E-...-S1G9-V3

1) Max. cable length 25 m.

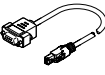
Ordering data – Adapters			
	Description	Part no.	Type
	Required in combination with the servo drive CMMT-AS as adapter between encoder cable NEBM-M12G8-...-V3 and interface X3 (position encoder 2)	8106112	NEFM-S1G9-K-0,5-R3G8