

## Spindle axes ELGT-BS

**FESTO**



## Key features

### At a glance

- Compact design
- Optimised for use in the electronics and automotive industry: materials include less than 1% copper and zinc
- Optimal ratio between installation space and working space due to the optimised axis design
- Simple integration of motors with motor mounting kits
- Position detection with inductive proximity switches SIES-8M and magnetic proximity switches SME/SMT-8M

### Characteristic values of the axes

The specifications shown in the table are maximum values.

The precise values for each of the variants can be found in the relevant data sheet in the catalogue.

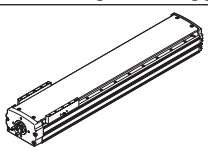
Design	Size	Spindle pitch [mm/rev]	Working stroke [mm]	Max. speed [m/s]	Repetition accuracy [mm]	Max. feed force Fx [N]	Guide characteristics				
							Forces and torques				
							Fy [N]	Fz [N]	Mx [Nm]	My [Nm]	Mz [Nm]
<b>Recirculating ball bearing guide</b>											
	90	10	50 ... 1000	0.5	±0.02	1054	4710	5600	65	51	51
		20	50 ... 1000	1	±0.02	810	4710	5600	65	51	51
	120	10	100 ... 1100	0.5	±0.02	1265	6800	8090	300	310	310
		20	100 ... 1100	1	±0.02	805	6800	8090	300	310	310
	160	10	100 ... 1400	0.5	±0.02	1575	9550	11370	600	560	560
		20	100 ... 1400	1	±0.02	1045	9550	11370	600	560	560

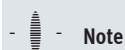

### Note

Engineering software

→ [www.festo.com](http://www.festo.com)

### Complete system comprising spindle axis, motor, motor controller and motor mounting kit

→ Page 44

Spindle axis with recirculating ball bearing guide



#### Motor



Servo motor:  
EMMT-AS, EMME-AS  
Stepper motor:  
EMMS-ST  
Integrated drive:  
EMCA-EC

#### Servo drive



Servo drive:  
CMMT-AS  
Servo drive for extra-low voltage:  
CMMT-ST

#### Motor mounting kit

##### Axial kit



##### Parallel kit

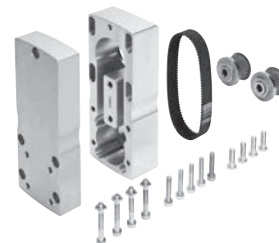

## Type codes

001	Series
<b>ELGT</b>	Gantry axis

002	Drive system
<b>BS</b>	Ball screw drive

003	Size
<b>90</b>	90
<b>120</b>	120
<b>160</b>	160

004	Stroke
<b>50</b>	50
<b>100</b>	100
<b>150</b>	150
<b>200</b>	200
<b>250</b>	250
<b>300</b>	300
<b>350</b>	350
<b>400</b>	400
<b>450</b>	450
<b>500</b>	500
<b>550</b>	550
<b>600</b>	600
<b>650</b>	650
<b>700</b>	700
<b>750</b>	750
<b>800</b>	800
<b>850</b>	850
<b>900</b>	900
<b>950</b>	950
<b>1000</b>	1000
<b>1100</b>	1100
<b>1200</b>	1200
<b>1300</b>	1300
<b>1400</b>	1400

005	Spindle pitch
<b>10P</b>	10 mm
<b>20P</b>	20 mm

006	Additional slide
	None
<b>ZL</b>	1 slide left
<b>ZR</b>	1 slide right

007	Anti-reflection coating
	None
<b>AR</b>	Outer surfaces

Peripherals overview

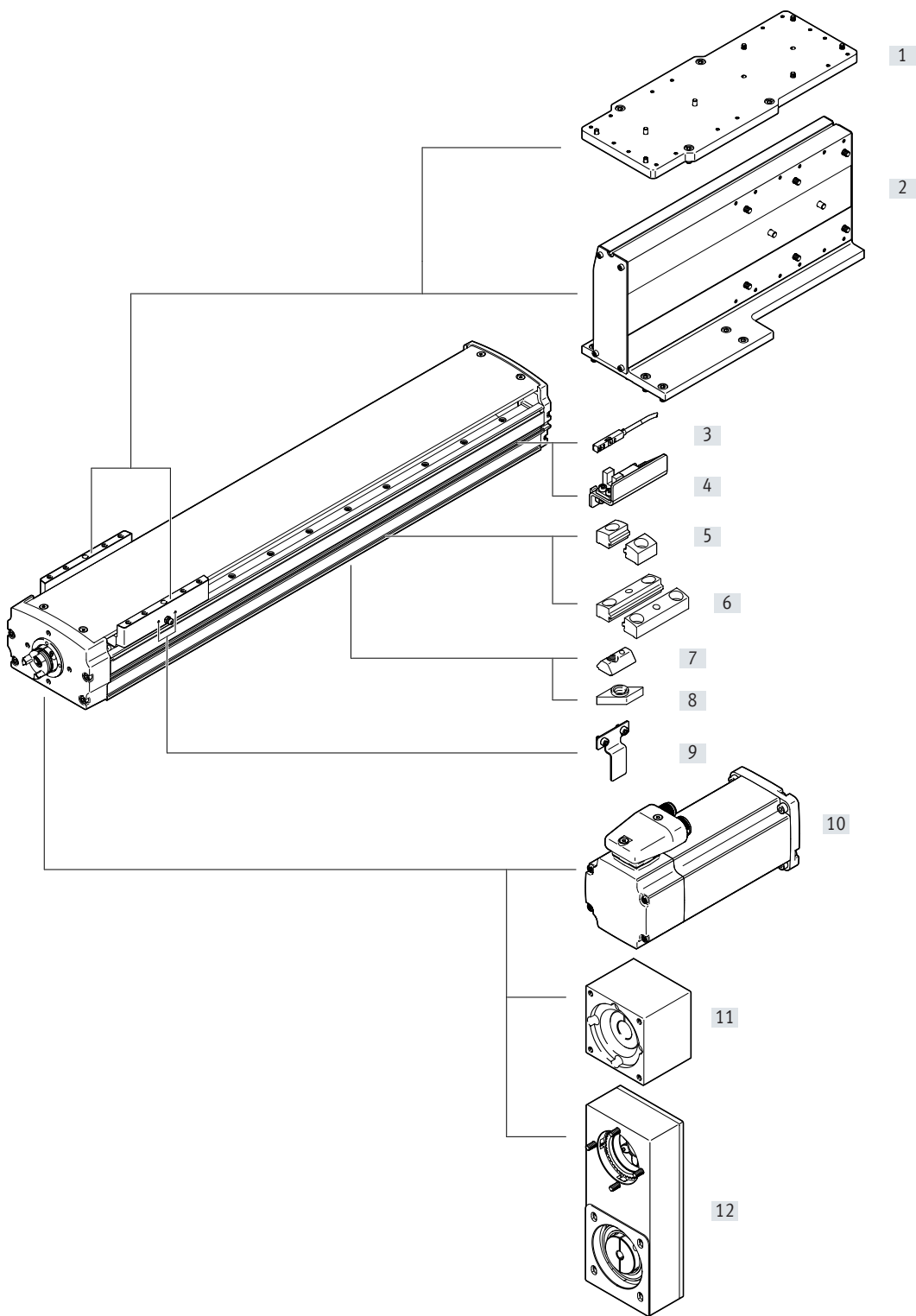



## Peripherals overview

Accessories		
Type/order code	Description	→ Page/Internet
[1] Adapter kit EHAM-MA-L9	<ul style="list-style-type: none"> <li>For axis/axis mounting</li> <li>When motors are mounted using parallel kits, this may lead to interfering contours. In this case, height compensation is required for the adapter plate. (Download CAD data → <a href="http://www.festo.com">www.festo.com</a>)</li> </ul>	34
[2] Angle kit EHAM-AK-L9	For axis/axis mounting	30
[3] Proximity switch SIES-8M	Inductive proximity switches, for T-slot	49
Proximity switch SME/SMT-8M	Magnetic proximity switches, for T-slot	49
[4] Sensor bracket EAPM-L9-SHE	For mounting third-party sensors on the axis	48
[5] Profile mounting EAHF-L2-...-P	For mounting the axis on the side of the profile	45
[6] Profile mounting EAHF-L2-...-P-S	For mounting the axis on the side of the profile	46
[7] Slot nut NST	For mounting attachments	50
[8] Slot nut ABAN	For mounting attachments	50
[9] Switch lug EAPM-L9	For sensing the slide position in conjunction with inductive proximity switches SIES-8M	47
[10] Motor EMCA-EC EMME-AS EMMS-ST EMMT-AS	Motors specially matched to the axis, with or without brake	44
[11] Axial kit EAMM-A	For axial motor mounting	44
[12] Parallel kit EAMM-U	For parallel motor mounting	44

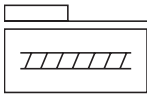
## Data sheet



-  Size  
90 ... 160 mm
-  Stroke length  
50 ... 1400 mm
-  [www.festo.com](http://www.festo.com)



General technical data				
Size		90	120	160
Design		Electromechanical linear axis With ball screw		
Mounting position		Any		
Motor type		Stepper motor Servo motor		
Guide		Recirculating ball bearing guide		
Type of spindle		Ball screw		
Working stroke	[mm]	50 ... 1000	100 ... 1100	100 ... 1400
Stroke reserve	[mm]	0		
Max. feed force F <sub>x</sub>				
[10P]	[N]	1054	1265	1575
[20P]	[N]	810	805	1045
Feed constant				
[10P]	[mm/rev]	10		
[20P]	[mm/rev]	20		
No-load torque at low travel speed				
[10P]	[Nm]	0.08	0.08	0.2
[20P]	[Nm]	0.04	0.08	0.14
No-load torque at max. travel speed				
[10P]	[Nm]	0.3	0.3	0.4
[20P]	[Nm]	0.2	0.3	0.4
Max. radial force on drive shaft				
[10P]	[N]	290		340
[20P]	[N]	290		290
Max. rotational speed <sup>1)</sup>	[rpm]	3000		
Max. speed				
[10P]	[m/s]	0.5		
[20P]	[m/s]	1		
Max. acceleration	[m/s <sup>2</sup> ]	15		
Repetition accuracy	[mm]	±0.02		
Reversing backlash	[mm]	≤ 0.15		

1) Rotational speed and velocity are stroke-dependent

Operating and environmental conditions				
		90	120	160
Ambient temperature <sup>1)</sup>	[°C]	0 ... +50		
Degree of protection		IP20		
Duty cycle	[%]	100		
Maintenance interval		Lifetime lubrication		

1) Note operating range of proximity switches

## Data sheet

Weight [g]						
Size	90		120		160	
Spindle pitch [mm/rev]	10	20	10	20	10	20
Basic weight with 0 mm stroke	4380	4353	5259	5235	9564	9601
Additional weight per 10 mm stroke	104	102	124	122	188	189
Moving load	1628	1645	2019	2036	3835	3842
Additional slide weight	1416	1416	1770	1770	3142	3142

Spindle						
Size	90		120		160	
Spindle pitch [mm/rev]	10	20	10	20	10	20
Diameter [mm]	16	15	16	15	20	

Mass moment of inertia						
Size	90		120		160	
Spindle pitch [mm/rev]	10	20	10	20	10	20
$J_0$ [kg mm <sup>2</sup> ]	12.52	22.91	13.06	26.54	31.75	63.42
$J_H$ per metre stroke [kg mm <sup>2</sup> ]	34.53	25.22	34.53	25.22	80.9	90.27
$J_L$ per kg payload [kg mm <sup>2</sup> ]	2.53	10.13	2.53	10.13	2.53	10.13
$J_W$ Slide [kg mm <sup>2</sup> ]	3.58	14.35	4.48	17.93	8.2	32.84

The mass moment of inertia  $J_A$  of the entire axis is calculated as follows:  $J_A = J_0 + J_W + J_H \times \text{working stroke [m]} + J_L \times m_{\text{payload [kg]}}$

## Homing

Homing can be carried out in two ways:

- Against a fixed stop
- Using a reference switch

The following values must be observed:

Size	90	120	160
Max. impact energy [m]	2		
At max. speed of the homing travel [m/s]	0.01		
With max. payload [kg]	40		

## Materials

Sectional view

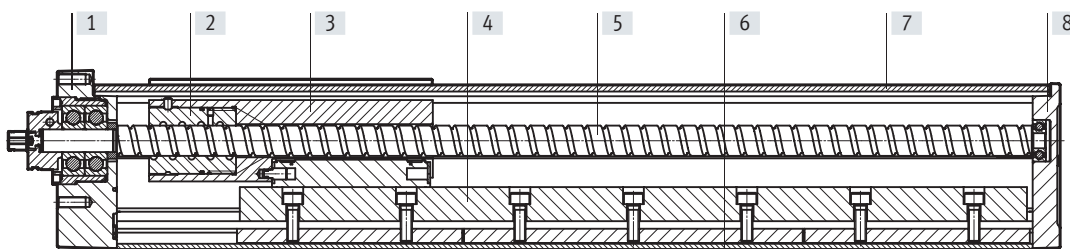

Axis	
[1] Drive cover	Die-cast aluminium, painted
[2] Spindle nut	Steel
[3] Slide	Anodised wrought aluminium alloy
[4] Slide guide	Steel
[5] Spindle	Steel
[6] Profile	Anodised wrought aluminium alloy
[7] Housing	Die-cast aluminium, painted
[8] End cap	Die-cast aluminium, painted
- Note on materials	Contains paint-wetting impairment substances
	RoHS-compliant
	Metals with copper, zinc or nickel as the main constituent are excluded from use. Exceptions are nickel in steel, chemically nickel-plated surfaces, printed circuit boards, cables, electrical plug connectors and coils.

## Data sheet

### Characteristic load values

The indicated forces and torques refer to the centre of the guide. The point of application of force is the point where the centre of the guide and the longitudinal centre of the slide intersect. These values must not be exceeded during dynamic operation. Special attention must be paid to the deceleration phase.

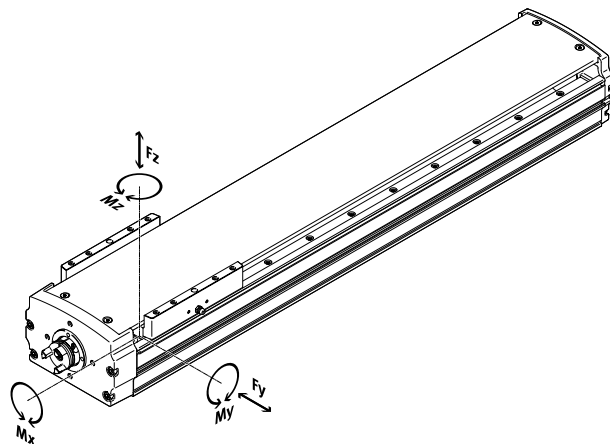

Distance from the slide surface to the centre of the guide

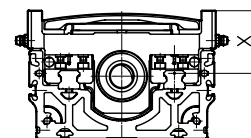

#### Distance from the slide surface to the centre of the guide

Size		90	120	160
Dimension x	[mm]	66	48	57.5

#### Max. permissible forces and torques for a service life of 5000 km

Size		90	120	160
F <sub>y</sub> max.	[N]	4710	6800	9550
F <sub>z</sub> max.	[N]	5600	8090	11370
M <sub>x</sub> max.	[Nm]	65	300	600
M <sub>y</sub> max.	[Nm]	51	310	560
M <sub>z</sub> max.	[Nm]	51	310	560

#### Basic load ratings

Size		90	120	160			
Spindle pitch	[mm/rev]	10	20	10	20	10	20

#### Ball screw

Dynamic C <sub>dyn</sub>	[N]	10700	7100	10700	7100	19400	8200
Static C <sub>0</sub>		22700	14700	22700	14700	50100	18600

#### Note

For a guide system to have a service life of 5000 km, the load comparison factor must have a value of  $f_v \leq 1$ , based on the maximum permissible forces and torques for a service life of 5000 km.

If the axis is subjected to two or more of the indicated forces and torques simultaneously, the following equation must be satisfied in addition to the indicated maximum loads:

Calculating the load comparison factor:

$$f_v = \frac{|F_{y1}|}{F_{y2}} + \frac{|F_{z1}|}{F_{z2}} + \frac{|M_{x1}|}{M_{x2}} + \frac{|M_{y1}|}{M_{y2}} + \frac{|M_{z1}|}{M_{z2}} \leq 1$$

F<sub>1</sub>/M<sub>1</sub> = dynamic value

F<sub>2</sub>/M<sub>2</sub> = maximum value



## Data sheet

## Calculating the service life

The service life of the guide depends on the load. To be able to make a statement as to the service life of the guide, the graph below plots the load comparison factor  $f_v$  against the service life.

These values are only theoretical. You must consult your local Festo contact for a load comparison factor  $f_v$  greater than 1.

Load comparison factor  $f_v$  as a function of service life  $l$ 

Example:

A user wants to move an  $x$  kg load. Using the formula (→ page 8) gives a value of 1.5 for the load comparison factor  $f_v$ . According to the graph, the guide would have a service life of approx. 1 500 km. Reducing the acceleration reduces the  $M_y$  and  $M_z$  values. A load comparison factor  $f_v$  of 1 now gives a service life of 5000 km.

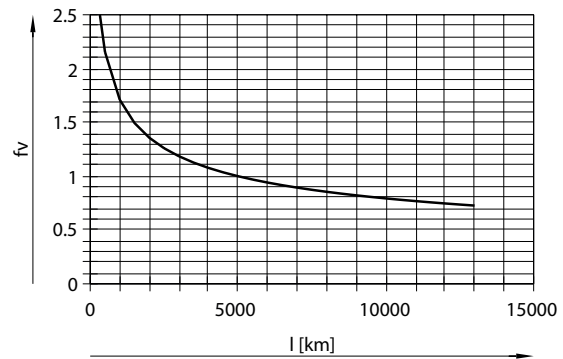

## Comparison of the characteristic load values for 5000 km with dynamic forces and torques of recirculating ball bearing guides

The characteristic load values of the bearing guides are standardised to ISO and JIS using dynamic and static forces and torques. These forces and torques are based on an expected service life of the guide system of 100 km to ISO or 50 km to JIS.

As the characteristic load values are dependent on the service life, the maximum permissible forces and torques for a 5000 km service life cannot be compared with the dynamic forces and torques of bearing guides to ISO/JIS.

To make it easier to compare the guide capacity of linear axes ELGT with bearing guides, the table below lists the theoretically permissible forces and torques for a calculated service life of 100 km. This corresponds to the dynamic forces and torques to ISO.

These 100 km values have been calculated mathematically and are only to be used for comparing with dynamic forces and torques to ISO. The drives must not be loaded with these characteristic values as this could damage the axes.

## Max. permissible forces and torques for a theoretical service life of 100 km (from a guide perspective only)

Size		90	120	160
$F_{y_{max}}$	[N]	17352	25051	35183
$F_{z_{max}}$	[N]	20631	29804	41887
$M_{x_{max}}$	[Nm]	239	1105	2210
$M_{y_{max}}$	[Nm]	188	1142	2063
$M_{z_{max}}$	[Nm]	188	1142	2063

Data sheet

Max. acceleration  $a$  as a function of payload  $m$

Size 90

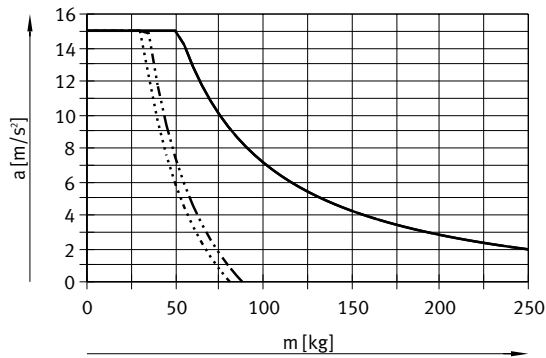

Size 120

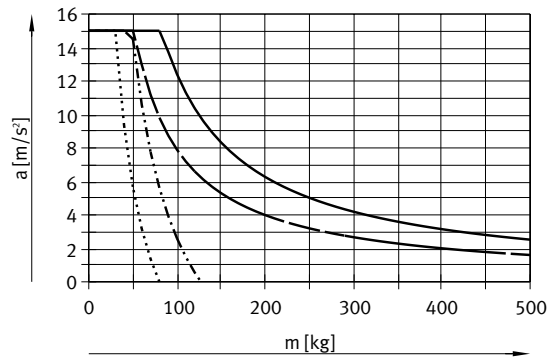

Size 160

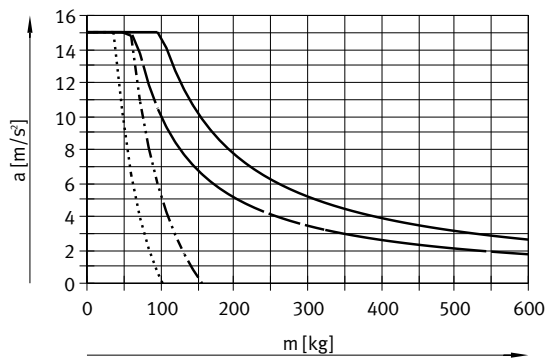

- [10P] and horizontal mounting position
- - - [20P] and horizontal mounting position
- · - · [10P] and vertical mounting position
- [20P] and vertical mounting position

Data sheet

Speed  $v$  as a function of working stroke  $l$

Size 90

[10P]

[20P]

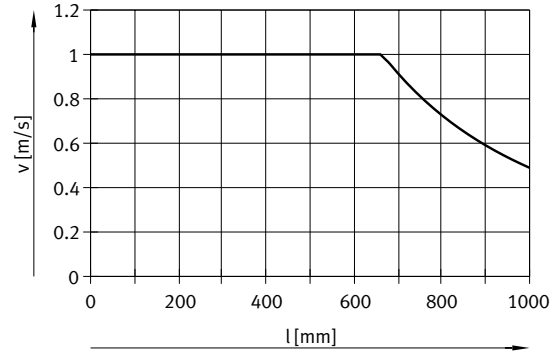
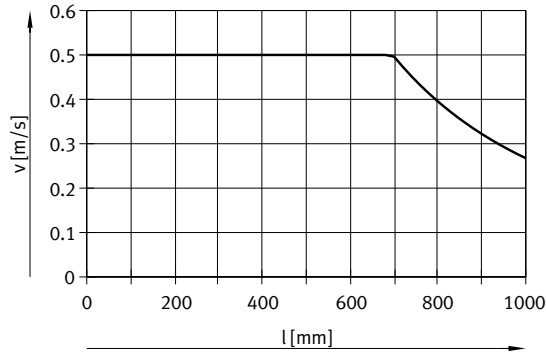

Size 120

[10P]

[20P]

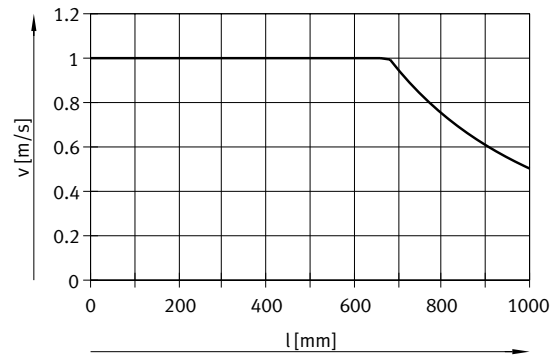
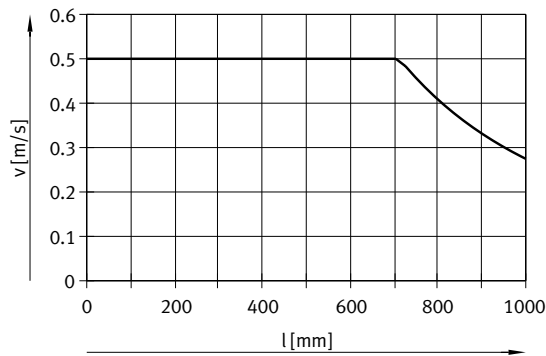

Size 160

[10P]

[20P]

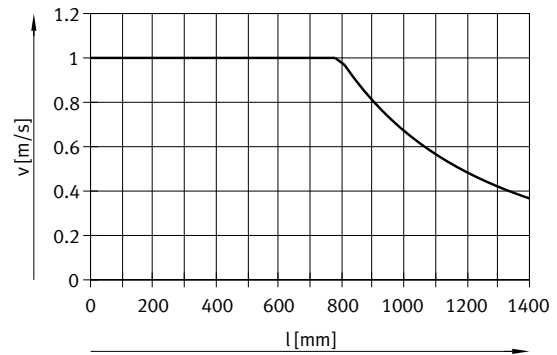
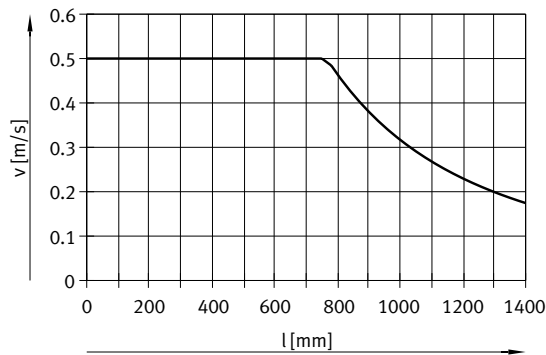

Data sheet

Rotational speed  $n$  as a function of working stroke  $l$

Size 90

[10P]

[20P]

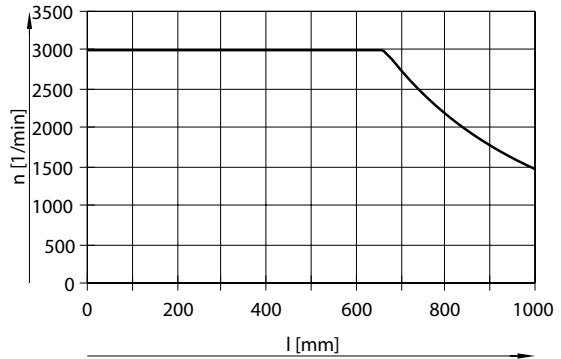
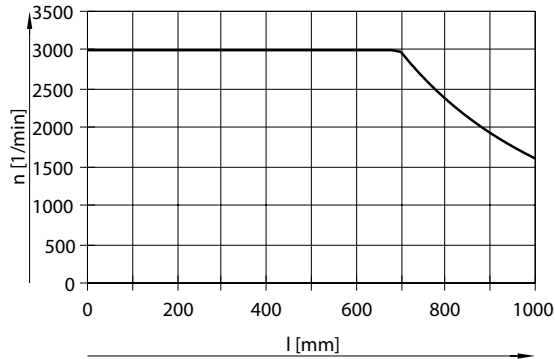

Size 120

[10P]

[20P]

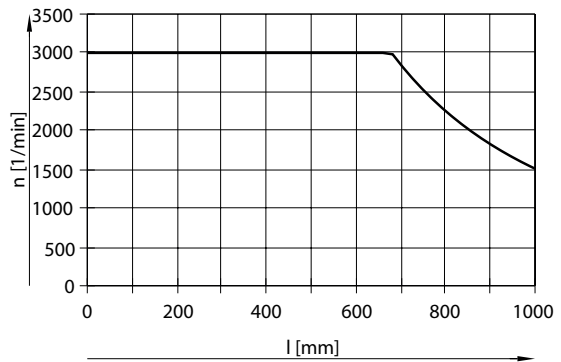
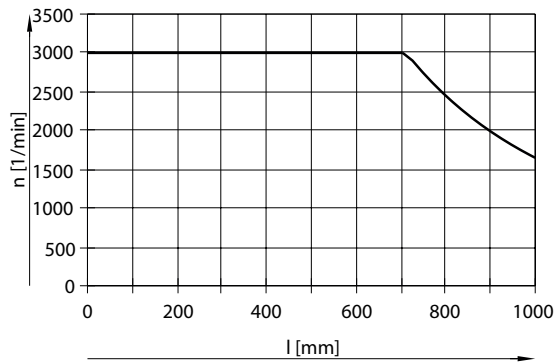

Size 160

[10P]

[20P]

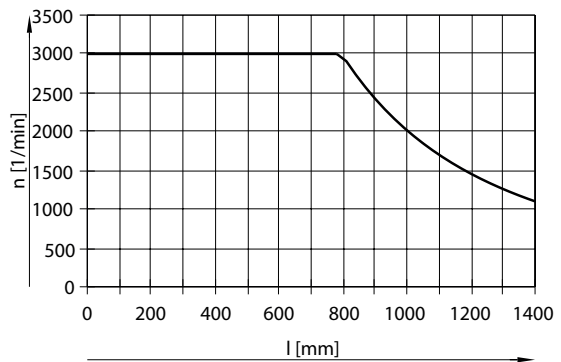
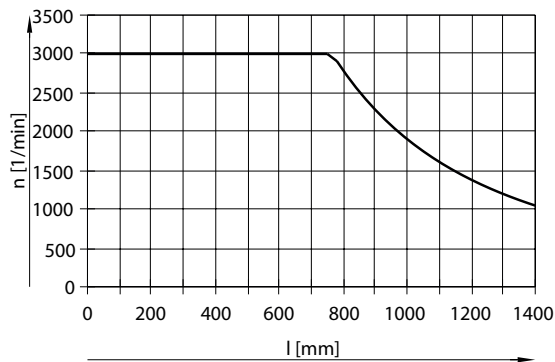

Data sheet

Theoretical feed force F as a function of input torque M

Size 90

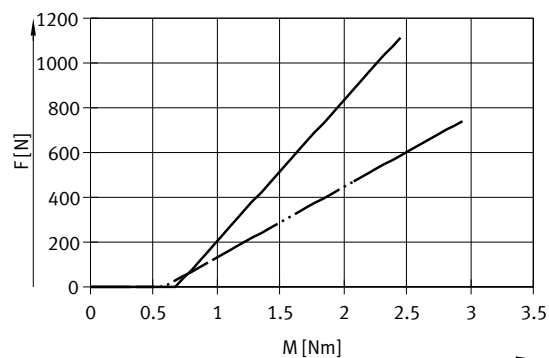

— [10P]  
- · - · - [20P]

Size 120

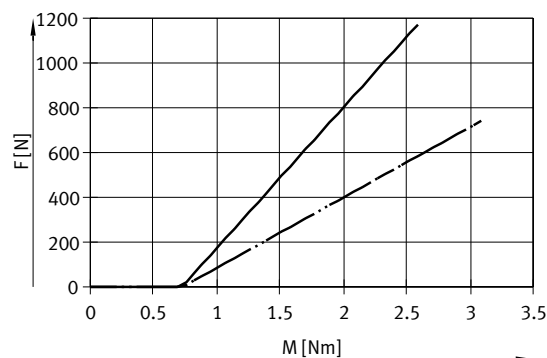

— [10P]  
- · - · - [20P]

Size 160

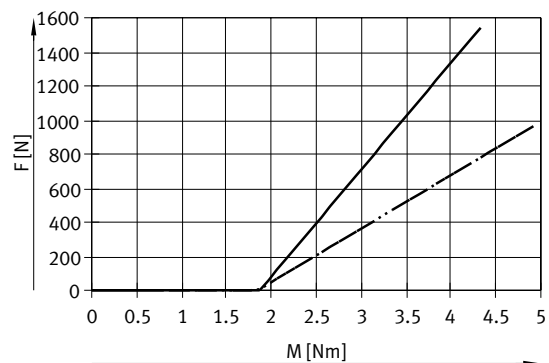

— [10P]  
- · - · - [20P]

Data sheet

Feed force F as a function of service life l

Size 90

[10P]

[20P]

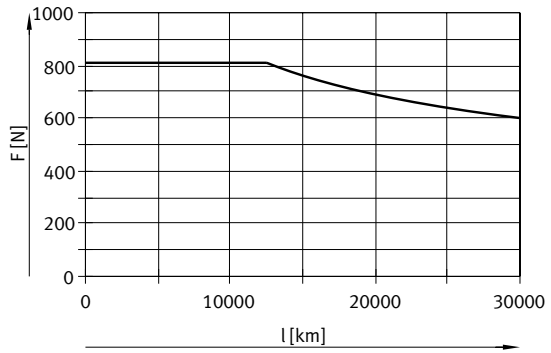
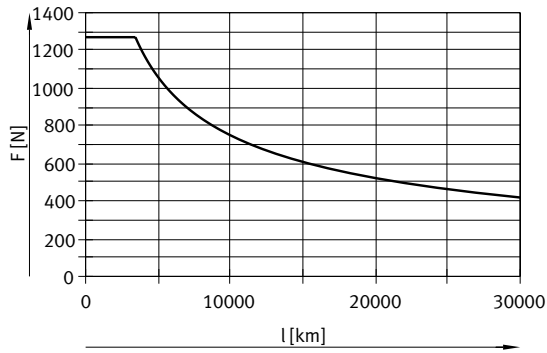

Size 120

[10P]

[20P]

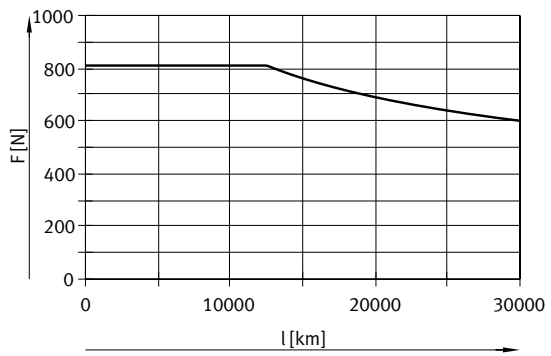
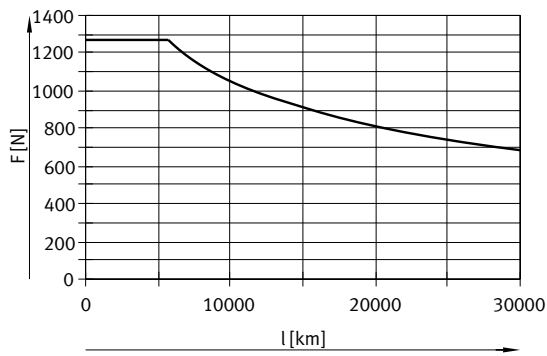

Size 160

[10P]

[20P]

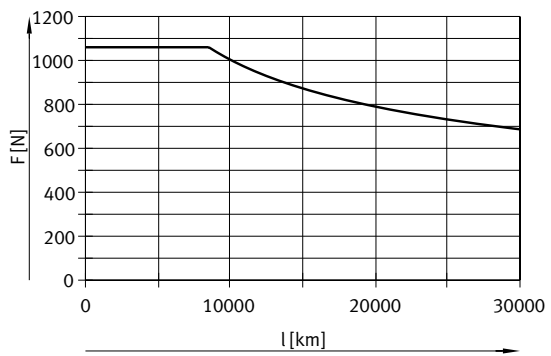
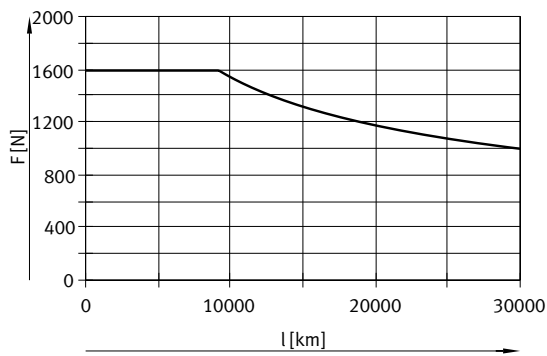

Data sheet

**Working stroke reduction**

For axis ELGT with additional slide ZL/ZR

For a spindle axis with additional slide, the working stroke is reduced by the length of the additional slide and the distance between both slides.

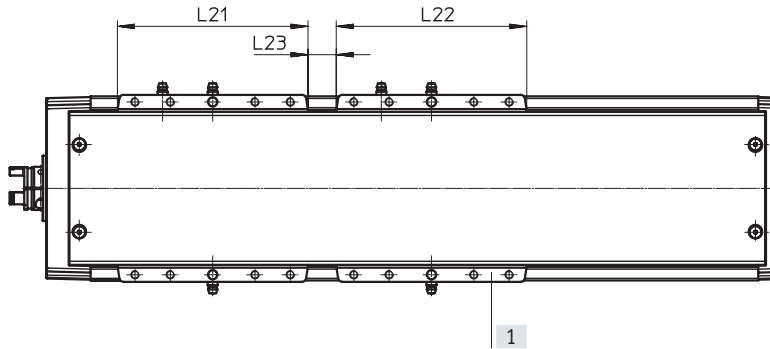

L21 = Slide length

L22 = Additional slide length

L23 = Distance between the two slides

[1] Additional slide

**Example:**

Type ELGT-BS-120-600-10P-ZR

Working stroke without additional slide = 600 mm

L23 = 5 mm

L21, L22 = 135 mm

Working stroke with additional slide = 460 mm  
(600 mm – 5 mm – 135 mm)

**Dimensions – Additional slide**

Size		90	120	160
Length L22	[mm]	150	135	175
Min. distance between the slides L23	[mm]	≥ 5	≥ 5	≥ 5

**Note**

Additional slides are available from a stroke ≥ 200 mm

## Data sheet

## Torsional moment of inertia

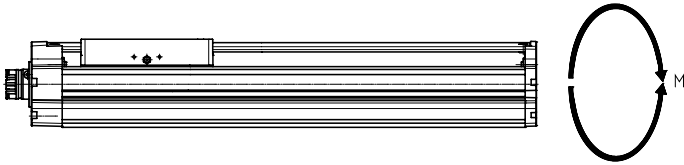

Size		90	120	160
It	[mm <sup>4</sup> ]	151000	506000	726000

## 2nd moments of area

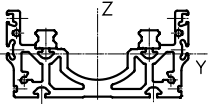

Size		90	120	160
Iy	[mm <sup>4</sup> ]	631000	966000	1411000
Iz	[mm <sup>4</sup> ]	1948000	6011000	15257000



Data sheet

Maximum permissible support spacing L (without profile mounting EAHF) as a function of force F

In order to limit deflection in the case of large strokes, the axis may need to be supported.

The following graphs can be used to determine the maximum permissible support spacing L as a function of force F acting on the axis. The deflection is  $f = 0.5 \text{ mm}$ .

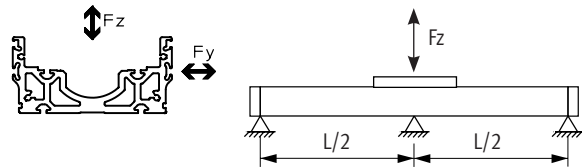

Size 90

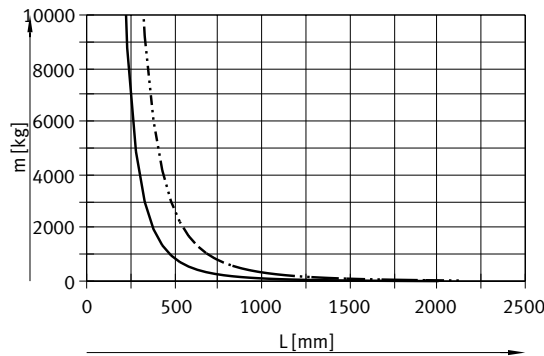

Size 120

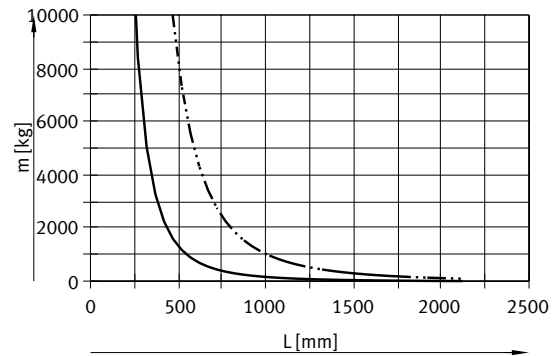

Size 160

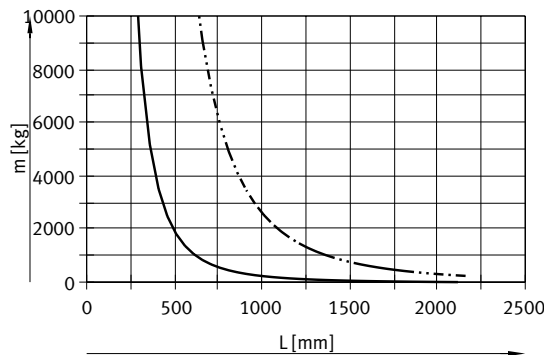

— Fy  
 - - - Fz

Recommended deflection limits

Adherence to the following deflection limits is recommended so as not to impair the functionality of the axes.

Greater deformation can result in increased friction, greater wear and reduced service life.

Size	Dynamic deflection (moving load)	Static deflection (stationary load)
90 ... 160	0.05% of the axis length, max. 0.5 mm	0.1% of the axis length

## Data sheet

## Dimensions

Download CAD data → [www.festo.com](http://www.festo.com)

Size 90

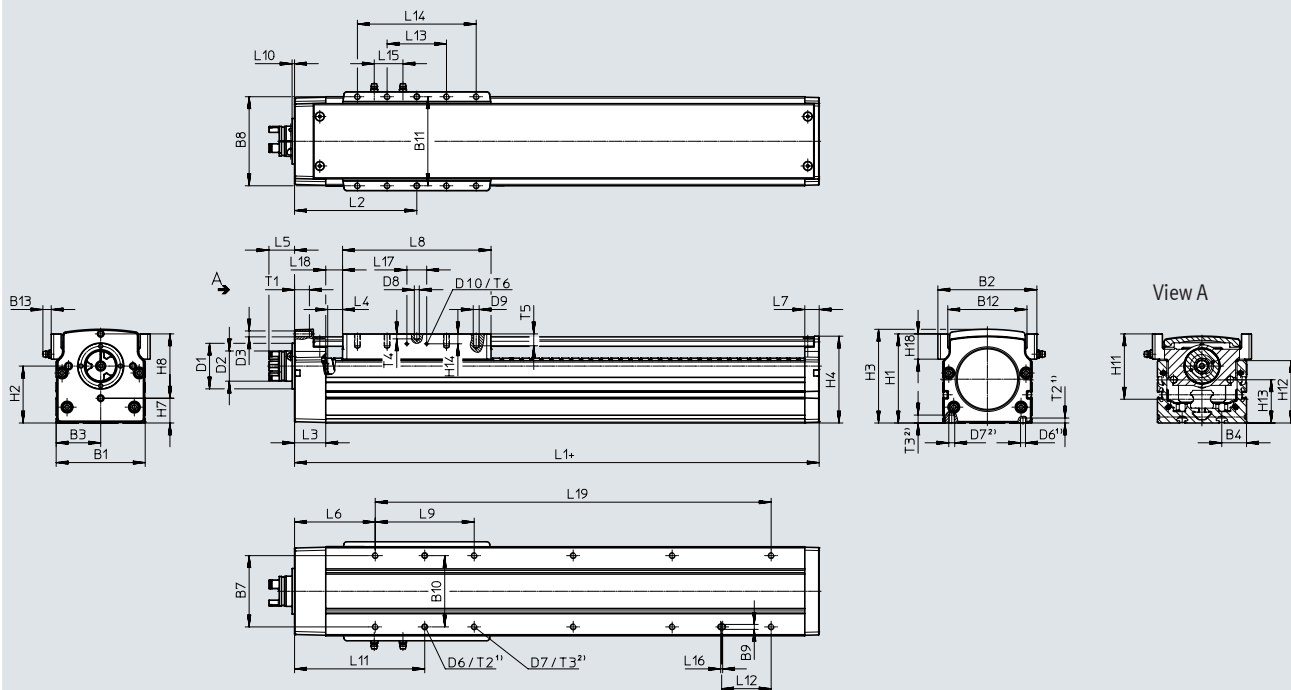

+ = plus stroke length

- 1) There are always 2 centring holes per axis
- 2) The number of threaded holes depends on the stroke → page 19

-  - **Note**

To avoid distortion in the slide, the bearing surfaces of the attachments must maintain a flatness of at least 0.03 mm over 200 mm.

## Data sheet

Size	B1	B2	B3	B4	B7	B8	B9	B10	B11	B12	B13	D1 ∅	D2 ∅	D3	D6 <sup>1)</sup> ∅ H7	D7 <sup>2)</sup>	D8 ∅ H7	D9
[mm]							H7	±0.03	±0.03									
90	90	100	45	25	72	90	5	72	90	80	8.4	46	30.5	M6	5	M6	5	M6

Size	D10	H1	H2	H3	H4	H7	H8	H11	H12	H13	H14	H18	L1	L2	L3	L4	L5	L6
[mm]														min.				
90	M3	90	57.5	95	88	25	65	66	63	43.7	10	25.5	230	123.5	31.5	15	25.9	81.5

Size	L7	L8	L9	L10	L11	L12	L13	L14	L15	L16	L17	L18	T1	T2 <sup>1)</sup>	T3 <sup>2)</sup>	T4	T5	T6
[mm]																		
90	14.5	150	100	2.5	131.5	50	60	120	29	2	20	17	15	5	8	5	12	6

Size	Stroke	Number of threaded holes	Number of spacings L9	L19
[mm]	[mm]			
90	50	4	1	100
	100	6	2	200
	150	6	2	200
	200	8	3	300
	250	8	3	300
	300	10	4	400
	350	10	4	400
	400	12	5	500
	450	12	5	500
	500	14	6	600
	550	14	6	600
	600	16	7	700
	650	16	7	700
	700	18	8	800
	750	18	8	800
	800	20	9	900
850	20	9	900	
900	22	10	1000	
950	22	10	1000	
1000	24	11	1100	

## Data sheet

## Dimensions

Download CAD data → [www.festo.com](http://www.festo.com)

Size 120 ... 160

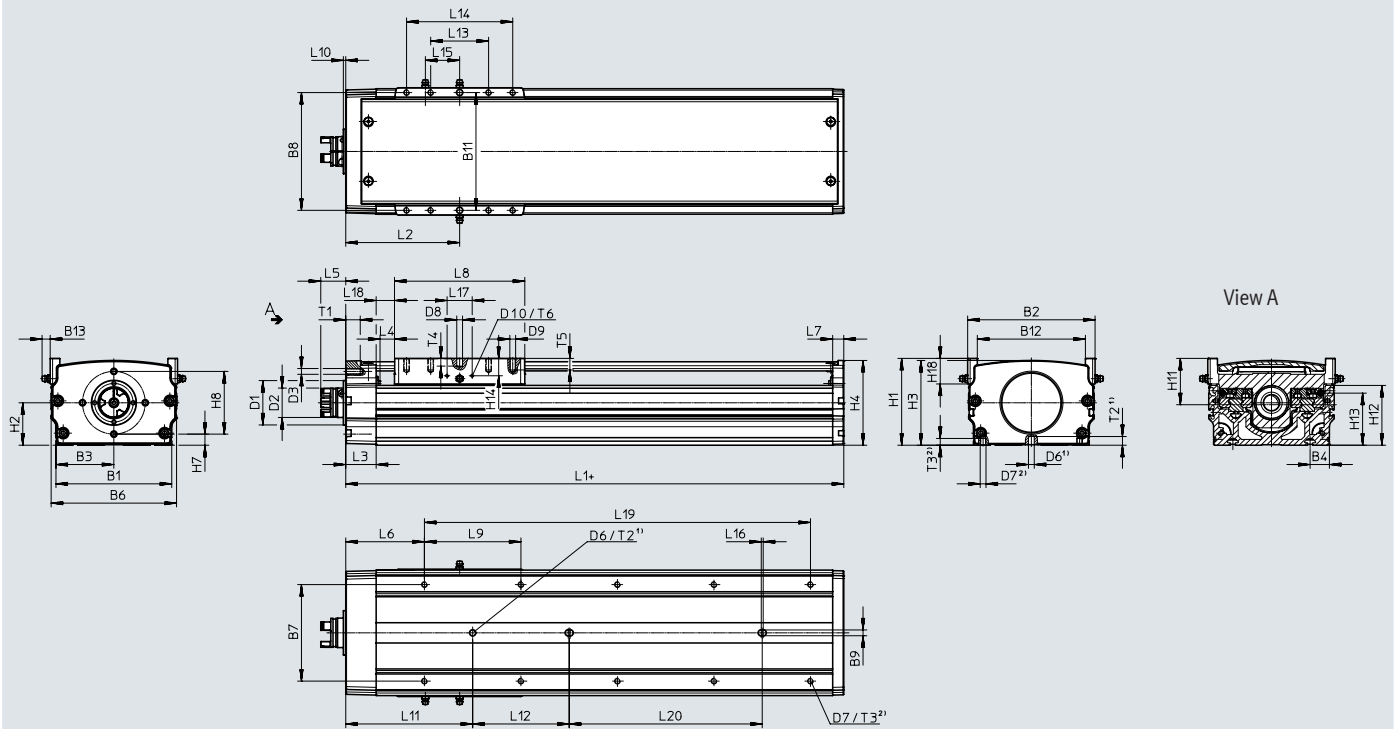

+ = plus stroke length

- 1) There are always 2 centring holes per axis
- 2) The number of threaded holes depends on the stroke → page 21

-  - **Note**

To avoid distortion in the slide, the bearing surfaces of the attachments must maintain a flatness of at least 0.03 mm over 200 mm.

## Data sheet

Size	B1	B2	B3	B4	B6	B7	B8	B9	B11	B12	B13	D1 ∅	D2 ∅	D3	D6 ∅ H7	D7	D8 ∅ H7	D9
[mm]								H7	±0.03									
120	120	132	60	20	130	100	122	6	122	112	8.4	46	30.5	M6	6	M6	6	M6
160	160	178	80	30	170	134	164	8	164	150	8.4	46	31.8	M6	8	M8	8	M8

Size	D10	H1	H2	H3	H4	H7	H8	H11	H12	H13	H14	H18	L1	L2 min.	L3	L4	L5	L6
[mm]																		
120	M3	90	44	88	88	11.5	65	48	62	54	18	26.5	216	118	31.5	15	25.9	81.5
160	M3	100	50	97	97	17.5	65	57.5	65	57.3	25	33	261	141	34.5	15	25.9	84.5

Size	L7	L8	L9	L10	L11	L12	L13	L14	L15	L16	L17	L18	T1	T2	T3	T4	T5	T6
[mm]																		
120	11.5	135	100	2.5	131.5	100	60	110	35.5	2	26	19	15	9	7	8	12	6
160	13.5	175	100	2.5	134.5	100	70	140	51.5	2	26	19	15	10	9	8	15	6

Size	Stroke	Number of threaded holes	Number of spacings L9	L19	L20
[mm]	[mm]				
120	300	10	4	400	200
	350	10	4	400	250
	400	12	5	500	300
	450	12	5	500	350
	500	14	6	600	400
	550	14	6	600	450
	600	16	7	700	500
	650	16	7	700	550
	700	18	8	800	600
	750	18	8	800	650
	800	20	9	900	700
	850	20	9	900	750
	900	22	10	1000	800
160	300	10	4	400	200
	350	12	5	500	250
	400	12	5	500	300
	450	14	6	600	350
	500	14	6	600	400
	550	16	7	700	450
	600	16	7	700	500
	650	18	8	800	550
	700	18	8	800	600
	750	20	9	900	650
	800	20	9	900	700
	850	22	10	1000	750
	900	22	10	1000	800
950	24	11	1100	850	
1000	24	11	1100	900	
1100	26	12	1200	1000	
1200	28	13	1300	1100	
1300	30	14	1400	1200	
1400	32	15	1500	1300	

## Data sheet

## Dimensions

Download CAD data → [www.festo.com](http://www.festo.com)

Profile

Size 90

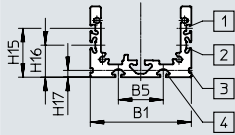

Size 120

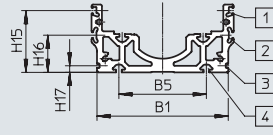

Size 160

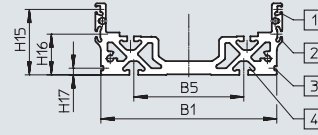

- [1] Slot for proximity switch
- [2] Slot for sensor bracket and proximity switch
- [3] Slot for profile mounting
- [4] Slot for retaining nut

Size	B1	B5	H15	H16	H17
[mm]					
90	90	40	43.5	28.5	6.1
120	120	80	56.5	34	6.1
160	160	100	59.5	37	6.1

## Data sheet

Ordering data					
Size	Spindle pitch	Stroke	Part no.	Type	
90	10	50	8124410	ELGT-BS-90-50-10P	
		100	8124401	ELGT-BS-90-100-10P	
		150	8124402	ELGT-BS-90-150-10P	
		200	8124403	ELGT-BS-90-200-10P	
		250	8124404	ELGT-BS-90-250-10P	
		300	8124405	ELGT-BS-90-300-10P	
		350	8124406	ELGT-BS-90-350-10P	
		400	8124407	ELGT-BS-90-400-10P	
		450	8124408	ELGT-BS-90-450-10P	
		500	8124409	ELGT-BS-90-500-10P	
		550	8124411	ELGT-BS-90-550-10P	
		600	8124412	ELGT-BS-90-600-10P	
		650	8124413	ELGT-BS-90-650-10P	
		700	8124414	ELGT-BS-90-700-10P	
	750	8124415	ELGT-BS-90-750-10P		
	800	8124416	ELGT-BS-90-800-10P		
	900	8124417	ELGT-BS-90-900-10P		
	1000	8124400	ELGT-BS-90-1000-10P		
	20		50	8124418	ELGT-BS-90-50-20P
			100	8124419	ELGT-BS-90-100-20P
			150	8124420	ELGT-BS-90-150-20P
200			8124421	ELGT-BS-90-200-20P	
250			8124422	ELGT-BS-90-250-20P	
300			8124423	ELGT-BS-90-300-20P	
350			8124424	ELGT-BS-90-350-20P	
400			8124425	ELGT-BS-90-400-20P	
450			8124426	ELGT-BS-90-450-20P	
500			8124427	ELGT-BS-90-500-20P	
550			8124428	ELGT-BS-90-550-20P	
600			8124429	ELGT-BS-90-600-20P	
650			8124430	ELGT-BS-90-650-20P	
700			8124431	ELGT-BS-90-700-20P	
750			8124432	ELGT-BS-90-750-20P	
800			8124433	ELGT-BS-90-800-20P	
900	8124434	ELGT-BS-90-900-20P			
1000	8124435	ELGT-BS-90-1000-20P			

## Data sheet

Ordering data					
Size	Spindle pitch	Stroke	Part no.	Type	
120	10	300	8124451	ELGT-BS-120-300-10P	
		350	8124452	ELGT-BS-120-350-10P	
		400	8124453	ELGT-BS-120-400-10P	
		450	8124454	ELGT-BS-120-450-10P	
		500	8124455	ELGT-BS-120-500-10P	
		550	8124456	ELGT-BS-120-550-10P	
		600	8124457	ELGT-BS-120-600-10P	
		650	8124458	ELGT-BS-120-650-10P	
		700	8124459	ELGT-BS-120-700-10P	
		750	8124460	ELGT-BS-120-750-10P	
		800	8124461	ELGT-BS-120-800-10P	
	900	8124462	ELGT-BS-120-900-10P		
	1000	8124463	ELGT-BS-120-1000-10P		
	20		300	8124496	ELGT-BS-120-300-20P
			350	8124497	ELGT-BS-120-350-20P
			400	8124498	ELGT-BS-120-400-20P
			450	8124499	ELGT-BS-120-450-20P
			500	8124500	ELGT-BS-120-500-20P
			550	8124501	ELGT-BS-120-550-20P
			600	8124502	ELGT-BS-120-600-20P
			650	8124503	ELGT-BS-120-650-20P
			700	8124504	ELGT-BS-120-700-20P
750			8124505	ELGT-BS-120-750-20P	
800			8124506	ELGT-BS-120-800-20P	
900	8124507	ELGT-BS-120-900-20P			
1000	8124508	ELGT-BS-120-1000-20P			



## Data sheet

Ordering data					
Size	Spindle pitch	Stroke	Part no.	Type	
160	10	300	8124513	ELGT-BS-160-300-10P	
		350	8124514	ELGT-BS-160-350-10P	
		400	8124515	ELGT-BS-160-400-10P	
		450	8124516	ELGT-BS-160-450-10P	
		500	8124517	ELGT-BS-160-500-10P	
		550	8124518	ELGT-BS-160-550-10P	
		600	8124519	ELGT-BS-160-600-10P	
		650	8124520	ELGT-BS-160-650-10P	
		700	8124521	ELGT-BS-160-700-10P	
		750	8124522	ELGT-BS-160-750-10P	
		800	8124523	ELGT-BS-160-800-10P	
	900	8124524	ELGT-BS-160-900-10P		
	1000	8124525	ELGT-BS-160-1000-10P		
	20		300	8124526	ELGT-BS-160-300-20P
			350	8124527	ELGT-BS-160-350-20P
			400	8124528	ELGT-BS-160-400-20P
			450	8124529	ELGT-BS-160-450-20P
			500	8124530	ELGT-BS-160-500-20P
			550	8124531	ELGT-BS-160-550-20P
			600	8124532	ELGT-BS-160-600-20P
			650	8124533	ELGT-BS-160-650-20P
			700	8124534	ELGT-BS-160-700-20P
			750	8124535	ELGT-BS-160-750-20P
800			8124536	ELGT-BS-160-800-20P	
900			8124537	ELGT-BS-160-900-20P	
1000	8124538	ELGT-BS-160-1000-20P			

## Ordering data – Modular product system

### Orientation guide

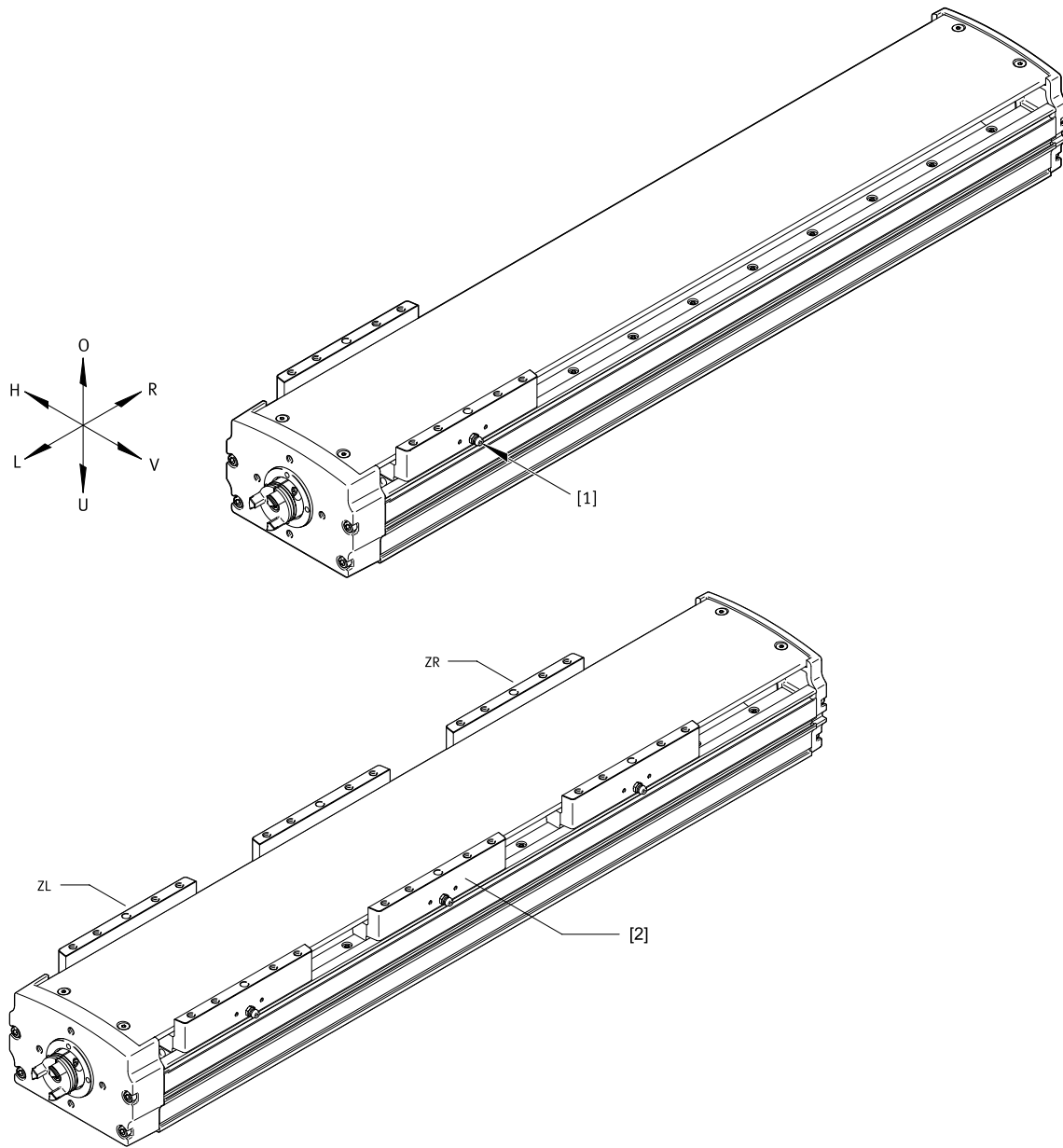

O top  
 U bottom  
 R right  
 L left  
 V front  
 H rear

[1] Lubrication connection  
 Slide:  
 [2] Standard slide  
 ZL 1 additional slide on left  
 ZR 1 additional slide on right

## Ordering data – Modular product system

Ordering table						
Size	90	120	160	Conditions	Code	Enter code
Module no.	8121224	8121225	8121226			
Series	ELGT				ELGT	ELGT
Drive system	Ball screw				-BS	-BS
Size	90	120	160		---	
Stroke	50	-			-50	
	100	100	100		-100	
	150	150	150		-150	
	200	200	200		-200	
	250	250	250		-250	
	300	300	300		-300	
	350	350	350		-350	
	400	400	400		-400	
	450	450	450		-450	
	500	500	500		-500	
	550	550	550		-550	
	600	600	600		-600	
	650	650	650		-650	
	700	700	700		-700	
	750	750	750		-750	
	800	800	800		-800	
	850	850	850		-850	
	900	900	900		-900	
	950	950	950		-950	
	1000	1000	1000		-1000	
-	1100	1100		-1100		
-	-		1200		-1200	
-	-		1300		-1300	
-	-		1400		-1400	
Spindle pitch	10 mm				-10P	
	20 mm				-20P	
Additional slide	Without					
	1 slide left			[1]	-ZL	
	1 slide right			[1]	-ZR	
Anti-reflection coating	Without					
	Outer surfaces				-AR	

[1] ZL, ZR Only with stroke  $\geq 200$  mm

Accessories

**Overview of mounting options**

Mounting of spindle axes ELGT-BS and axes ELGC/mini slide EGSC

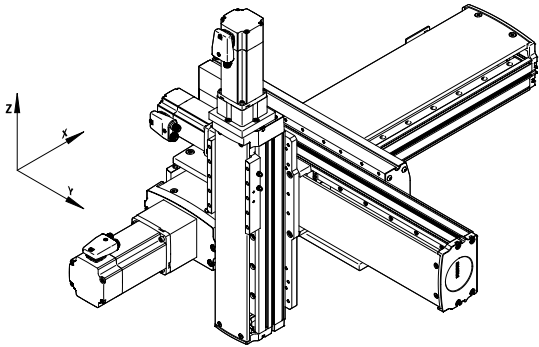

**Angle and adapter kits**

Type A	Type B	Type C	Type D
X-Y: Angle kit for maximum stroke 700 mm in Y direction	Y-Z: Adapter kit for maximum stroke 500 mm in Z direction	Y-Z: Adapter kit for maximum stroke 250 mm in Z direction	Y-Z: Adapter kit for ELGT/ELGC in Z direction

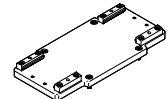
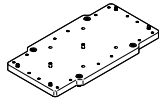
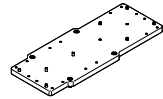
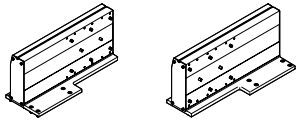

Type A  
ELGT with ELGT

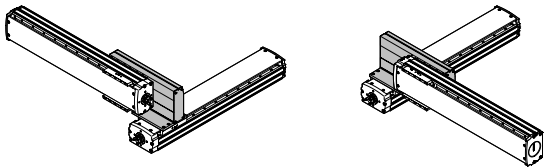

Type B  
ELGT with ELGT

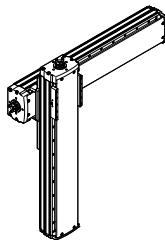

Type C  
ELGT with ELGT

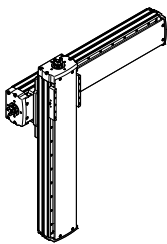

Type D  
ELGT with ELGC/EGSC

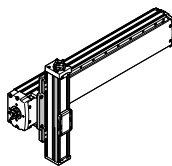

			Y-axis ELGT-BS		
	Size		90	120	160
	X-axis	90	■	-	-
	ELGT-BS	120	■	■	-
		160	-	■	■

			Z-axis ELGT-BS			ELGC		EGSC
	Size		90	120	160	60	80	60
	Y-axis	90	-	-	-	■	■	■
	ELGT-BS	120	■	-	-	-	■	-
		160	-	■	-	-	-	

			Y-axis Working stroke [mm]						
	Size		100	200	300	400	500	600	700
	X-axis/	90/90	A	A	A	A	A	A	-
	Y-axis	120/90	A	A	A	A	A	A	-
		120/120	A	A	A	A	A	A	-
		160/120	A	A	A	A	A	A	-
		160/160	A	A	A	A	A	A	A

			Z-axis Working stroke [mm]				
	Size		100	200	300	400	500
	Y-axis/	90/60	D	D	D	D	D
	Z-axis	90/80	D	D	D	D	D
		120/80	D	D	D	D	D
		120/90	C	B	B	B	B
		160/120	C	C	B	B	B

Accessories

**Angle kit EHAM-AK-L9-...-ML**

Combination matrix – Type A  
X-Y

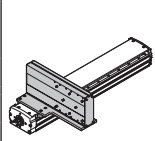

	Size	Y-axis: Assembly axis ELGT-BS		
		90	120	160
X axis:	90	8128210	–	–
Base axis ELGT-BS	120	8128209	8128208	–
	160	–	8128207	8128206

**Angle kit EHAM-AK-L9-...-MR**

Combination matrix – Type A  
X-Y

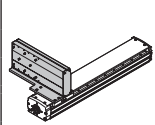

	Size	Y-axis: Assembly axis ELGT-BS		
		90	120	160
X axis:	90	8128215	–	–
Base axis ELGT-BS	120	8128214	8128213	–
	160	–	8128212	8128211

**Adapter kit EHAM-MA-L9-...**

Combination matrix – Type B/C/D  
Y-Z

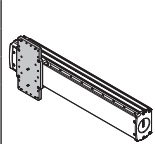

	Size	Z-axis: Assembly axis ELGT-BS						Assembly axis ELGC		Assembly axis EGSC
		Type B		Type C		Type D		60	80	60
		90	120	90	120	60	80			
Y-axis:	90	–	–	–	–	8128230	8128229	8128230	–	
Base axis ELGT-BS	120	8128227	–	8128232	–	–	8128228	–	–	
	160	–	8128226	–	8128231	–	–	–	–	

Accessories

**Angle kit EHAM-AK-L9-...-ML**

Material:

Anodised wrought aluminium alloy

RoHS-compliant

- Mounting option: base axis with the same size or one-size-down assembly axis
- Overview of mounting options → page 28

**Combination matrix – Type A**  
X-Y

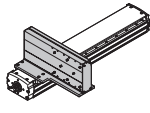
		Size	Y-axis: Assembly axis ELGT-BS	120	160
	X axis:	90	8128210	-	-
	Base axis ELGT-BS	120	8128209	8128208	-
		160	-	8128207	8128206

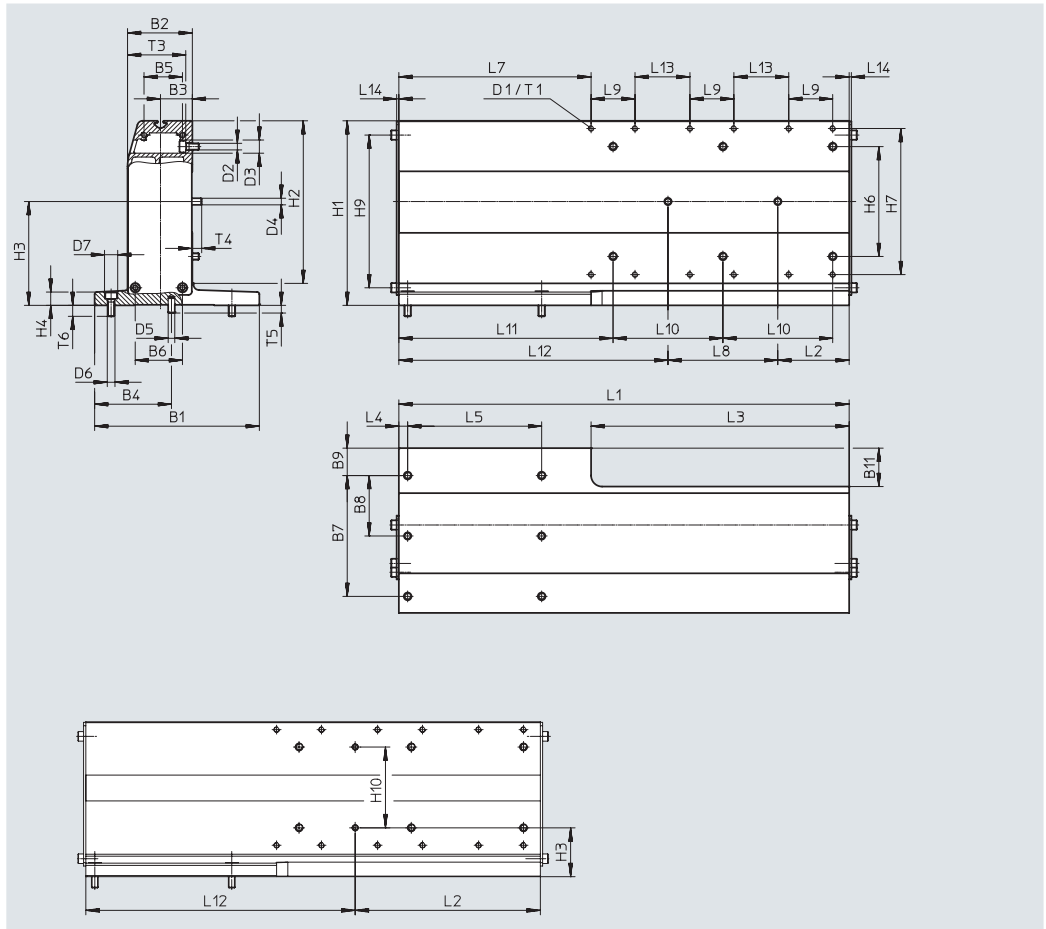
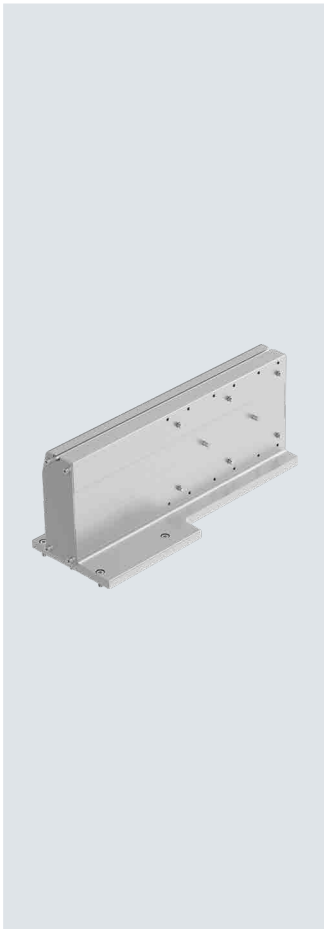

## Accessories

Dimensions and ordering data																	
For combination (size)	B1	B2	B3	B4	B5	B6	B7	B8	B9	B11	D1	D2 ∅	D3 ∅	D4 ∅ h7	D5 ∅ h7	D6 ∅	D7 ∅
90/90	150	44	19	75	22	27	120	60	15	55	M5	7	12	5	5	7	12
120/90	150	44	19	70	22	27	110	55	25	55	M5	7	12	5	6	7	12
120/120	150	59	29	70	35	43	110	55	25	35	M5	7	12	6	6	7	12
160/120	150	59	29	85	35	43	105	35	30	35	M5	7	12	6	8	9	14
160/160	170	69	34	85	43	52	140	70	15	50	M5	9	14	8	8	9	14

For combination (size)	D8	H1	H2	H3	H4	H6	H7	H9	H10 ±0.02	L1	L2	L3	L4	L5	L6	L7	L8 ±0.02
90/90	10	138	118	43.5	12	72	103	109	72	360	165	235	8	90	90	125	–
120/90	10	138	118	43.5	12	72	103	109	72	405	165	235	8	122	122	170	–
120/120	10	168	148	94.5	12	100	133	139	–	410	65	235	8	122	122	175	100
160/120	10	168	148	94.5	12	100	133	139	–	460	65	235	10	164	164	225	100
160/160	10	208	188	114.5	13	134	173	178	–	455	65	235	10	164	164	220	100

For combination (size)	L9	L10	L11	L12	L13	L14	T1	T3	T4	T5	T6	Weight [g]	Part no.	Type
90/90	40	100	145	195	50	2	12	39	5	5	10	3623	8128210	EHAM-AK-L9-90-L9-90-ML
120/90	40	100	190	240	50	2	12	39	5	7	10	4120	8128209	EHAM-AK-L9-120-L9-90-ML
120/120	40	100	195	245	50	2	12	53	8.5	7	10	5313	8128208	EHAM-AK-L9-120-L9-120-ML
160/120	40	100	245	295	50	2	12	53	8.5	7	11	6005	8128207	EHAM-AK-L9-160-L9-120-ML
160/160	40	100	240	290	50	2	12	61.5	9	7	11	7794	8128206	EHAM-AK-L9-160-L9-160-ML

Accessories

**Angle kit EHAM-AK-L9-...-MR**

Material:

Anodised wrought aluminium alloy

RoHS-compliant

- Mounting option: base axis with the same size or one-size-down assembly axis
- Overview of mounting options → page 28

**Combination matrix – Type A**  
X-Y

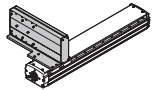

	Size	Y-axis: Assembly axis ELGT-BS		
X axis:	90	8128215	120	160
Base axis	120	8128214	-	-
ELGT-BS	160	-	8128212	8128211

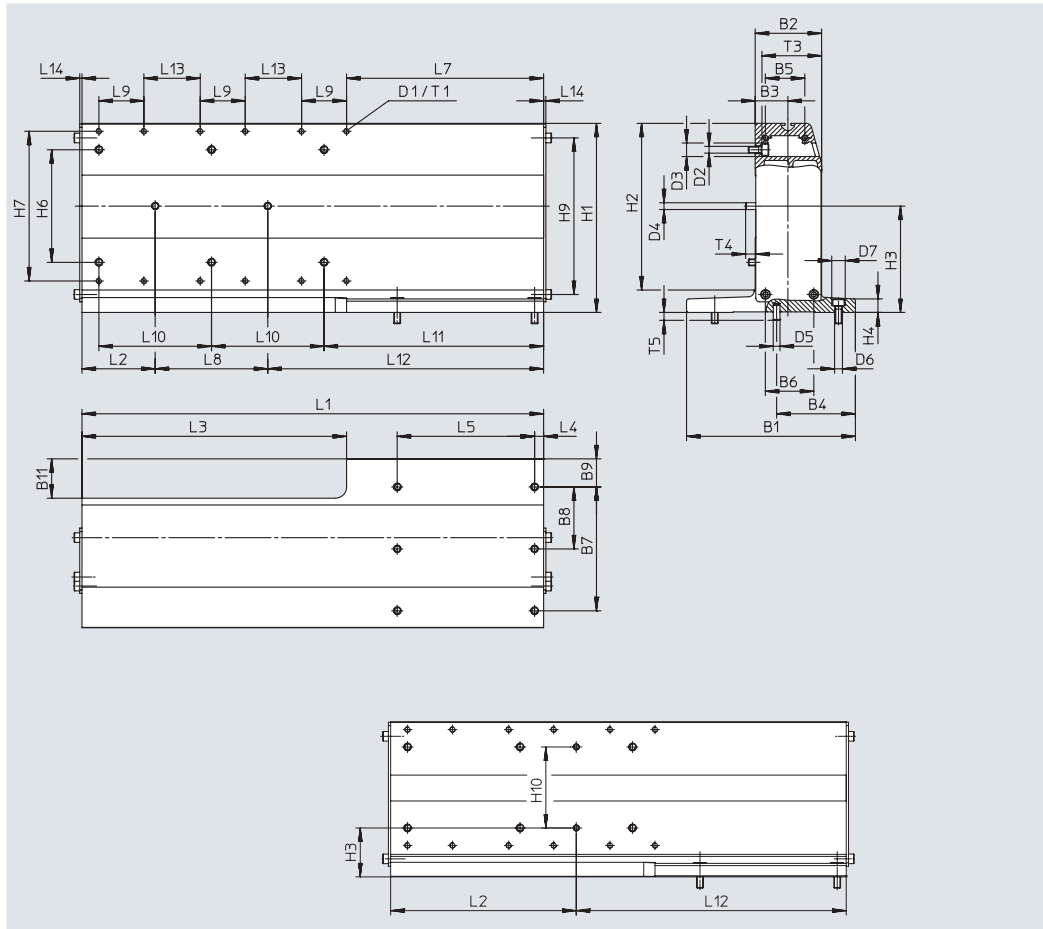
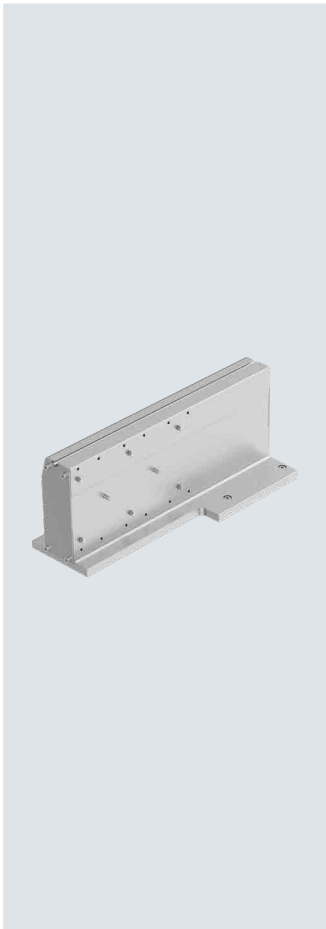



## Accessories

Dimensions and ordering data																	
For combination (size)	B1	B2	B3	B4	B5	B6	B7	B8	B9	B11	D1	D2 ∅	D3 ∅	D4 ∅ h7	D5 ∅ h7	D6 ∅	D7 ∅
90/90	150	44	19	75	22	27	120	60	15	55	M5	7	12	5	5	7	12
120/90	150	44	19	70	22	27	110	55	25	55	M5	7	12	5	6	7	12
120/120	150	59	29	70	35	43	110	55	25	35	M5	7	12	6	6	7	12
160/120	150	59	29	85	35	43	105	35	30	35	M5	7	12	6	8	9	14
160/160	170	69	34	85	43	52	140	70	15	50	M5	9	14	8	8	9	14

For combination (size)	D8	H1	H2	H3	H4	H6	H7	H9	H10 ±0.02	L1	L2	L3	L4	L5	L6	L7	L8 ±0.02
90/90	10	138	118	43.5	12	72	103	109	72	360	165	235	8	90	90	125	–
120/90	10	138	118	43.5	12	72	103	109	72	405	165	235	8	122	122	170	–
120/120	10	168	148	94.5	12	100	133	139	–	410	65	235	8	122	122	175	100
160/120	10	168	148	94.5	12	100	133	139	–	460	65	235	10	164	164	225	100
160/160	10	208	188	114.5	13	134	173	178	–	455	65	235	10	164	164	220	100

For combination (size)	L9	L10	L11	L12	L13	L14	T1	T3	T4	T5	T6	Weight [g]	Part no.	Type
90/90	40	100	145	195	50	2	12	39	5	5	10	3623	8128215	EHAM-AK-L9-90-L9-90-MR
120/90	40	100	190	240	50	2	12	39	5	7	10	4120	8128214	EHAM-AK-L9-120-L9-90-MR
120/120	40	100	195	245	50	2	12	53	8.5	7	10	5313	8128213	EHAM-AK-L9-120-L9-120-MR
160/120	40	100	245	295	50	2	12	53	8.5	7	11	6005	8128212	EHAM-AK-L9-160-L9-120-MR
160/160	40	100	240	290	50	2	12	61.5	9	7	11	7794	8128211	EHAM-AK-L9-160-L9-160-MR

Accessories

Adapter kit EHAM-MA-L9...

Material:

Anodised wrought aluminium alloy

RoHS-compliant

- For axis/axis mounting with adapter plate
- Mounting option: base axis with one-size-down assembly axis
- When motors are mounted using parallel kits, this may lead to interfering contours. In this case, height compensation is required for the adapter plate (download CAD data → [www.festo.com](http://www.festo.com))
- Overview of mounting options → page 28

Combination matrix – Type B  
Y-Z

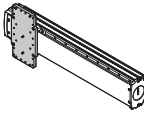

		Z-axis: Assembly axis ELGT-BS
	Size	90
Y-axis: Base axis ELGT-BS	120	8128227

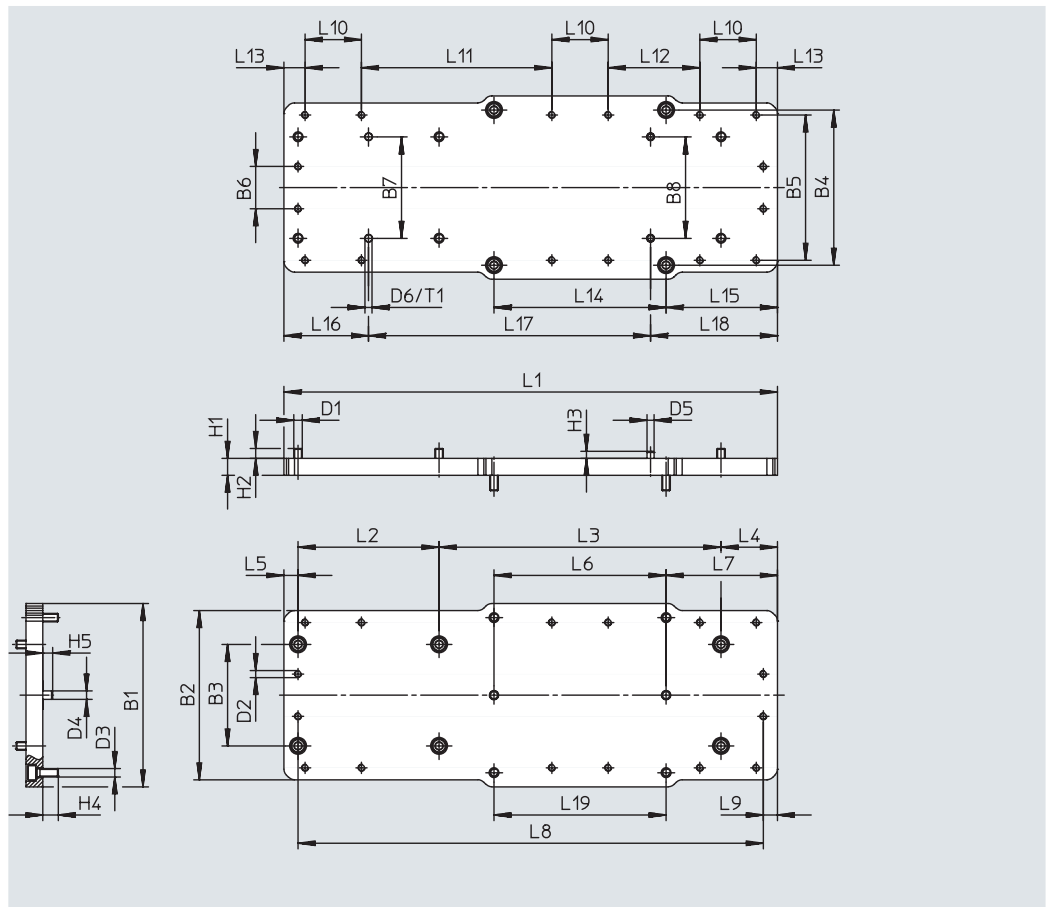
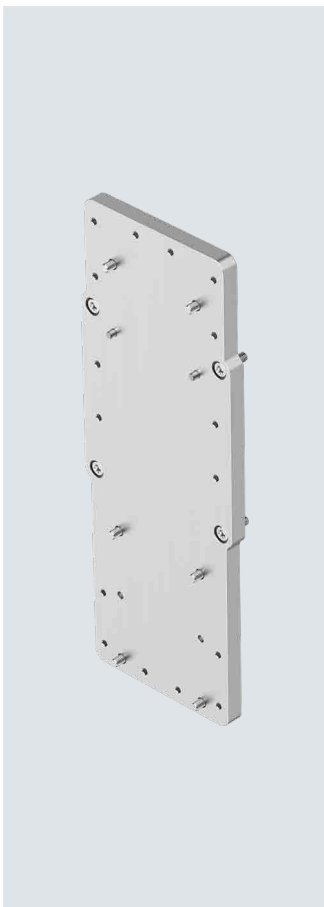

## Accessories

Dimensions and ordering data															
For combination (size)	B1	B2	B3	B4	B5	B6	B7	B8	D1	D2	D3	D4 ∅ h7	D5 ∅ h7	D6 ∅ h7	H1
120/90	130	120	72	110	103	30	72 ±0.02	72 ±0.02	M6	M5	M6	6	5	5	12
For combination (size)	H2	H3	H4	H5	L1	L2	L3	L4	L5	L6	L7	L8	L9	L10	L11
120/90	7	5	11	7	350	100	200	40	10	122	79	330	10	40	135
For combination (size)	L12	L13	L14	L15	L16	L17	L18	L19	T1	Weight [g]	Part no.	Type			
120/90	65	15	122	79	60	200	90	122	5.5	1437	<b>8128227</b>	<b>EHAM-MA-L9-120-L9-90</b>			

Accessories

Adapter kit EHAM-MA-L9-...

Material:

Anodised wrought aluminium alloy

RoHS-compliant

- For axis/axis mounting with adapter plate
- Mounting option: base axis with one-size-down assembly axis
- When motors are mounted using parallel kits, this may lead to interfering contours. In this case, height compensation is required for the adapter plate (download CAD data → [www.festo.com](http://www.festo.com))
- Overview of mounting options → page 28

Combination matrix – Type B  
Y-Z

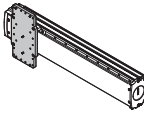

		Z-axis: Assembly axis ELGT-BS
	Size	120
Y-axis: Base axis ELGT-BS	160	8128226

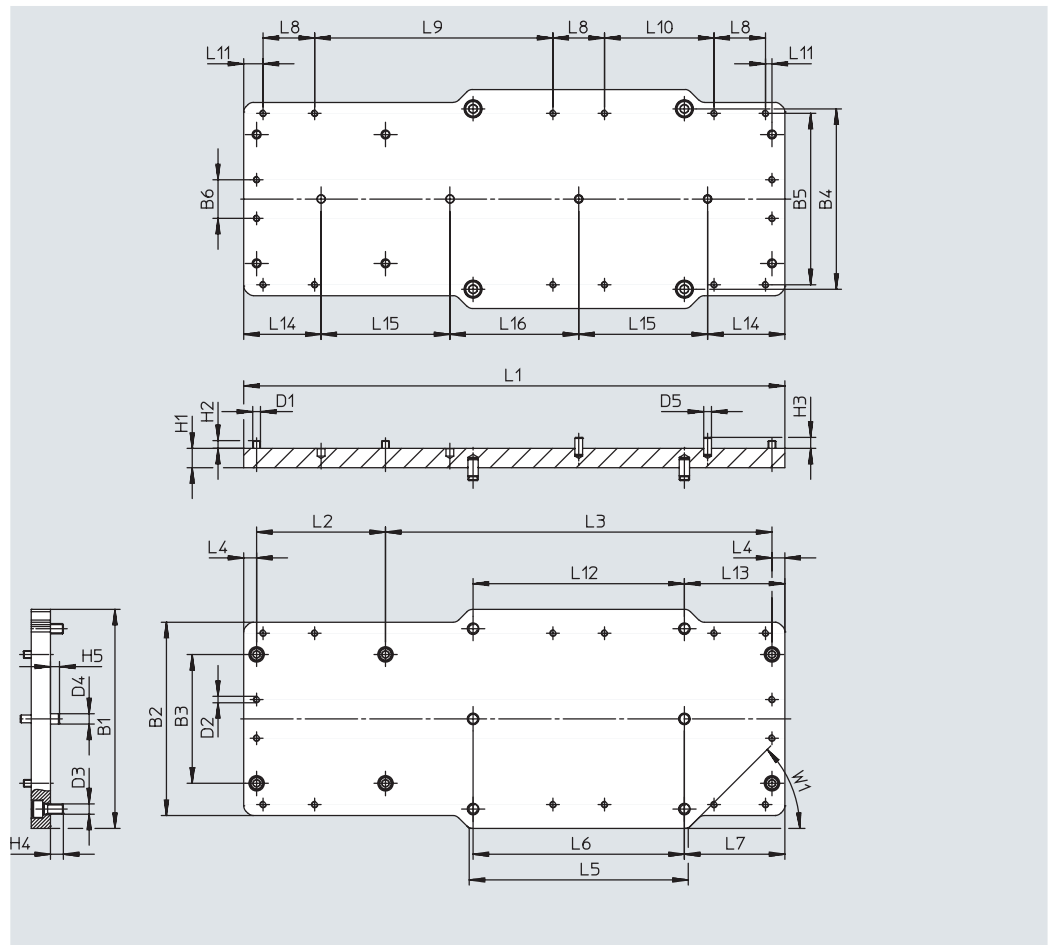

## Accessories

Dimensions and ordering data													
For combination (size)	B1	B2	B3	B4	B5	B6	D1	D2	D3	D4 ∅ h7	D5 ∅ h7	H1	H2
160/120	170	150	100	140	133	30	M6	M5	M8	8	6	15	6

Dimensions and ordering data													
For combination (size)	H3	H4	H5	L1	L2	L3	L4	L5	L6 ±0.02	L7	L8	L9	L10
160/120	8.5	10	7	420	100	300	10	170	164	78	40	185	85

For combination (size)	L11	L12	L13	L14	L15 ±0.02	L16	W1	Weight [g]	Part no.	Type
160/120	15	164	78	60	100	100	45°	2748	<b>8128226</b>	<b>EHAM-MA-L9-160-L9-120</b>

Accessories

Adapter kit EHAM-MA-L9-...-S

Material:  
Anodised wrought aluminium alloy  
RoHS-compliant

- For axis/axis mounting with adapter plate
- Mounting option: base axis with one-size-down assembly axis
- When motors are mounted using parallel kits, this may lead to interfering contours. In this case, height compensation is required for the adapter plate (download CAD data → [www.festo.com](http://www.festo.com))
- Overview of mounting options → page 28

Combination matrix – Type C

Y-Z

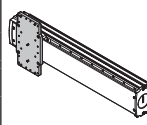
		Z-axis: Assembly axis ELGT-BS
	Size	90
Y-axis: Base axis ELGT-BS	120	8128232

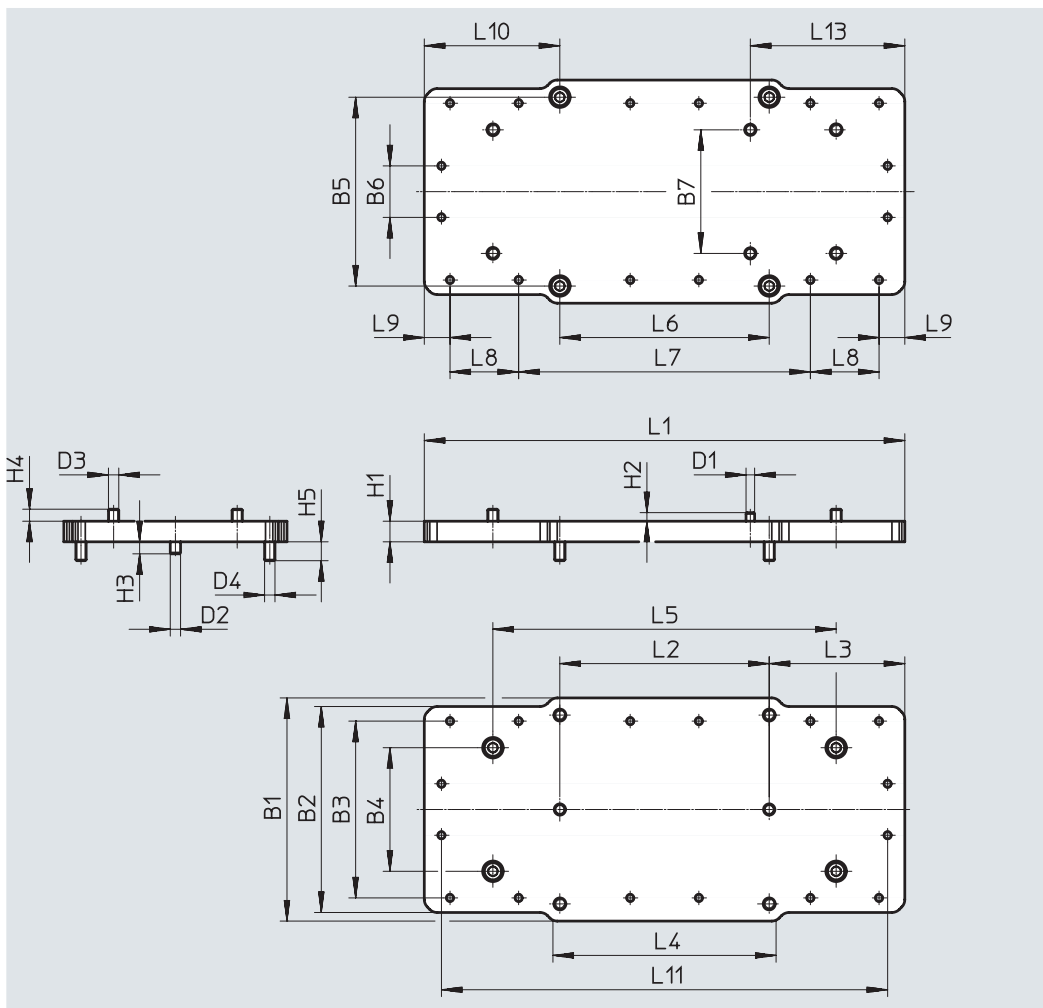

## Accessories

Dimensions and ordering data																		
For combination (size)	B1	B2	B3	B4	B5	B6	B7	D1 ∅ h7	D2 ∅ h7	D3	D4	H1	H2	H3	H4	H5	L1	L2
120/90	130	120	103	72	110	30	72 ±0.02	5	6	M6	M6	12	7	5	7	11	280	122 ±0.02

For combination (size)	L3	L4	L5	L6	L7	L8	L9	L10	L11	L13	Weight [g]	Part no.	Type
120/90	79	135	200	122	170	40	15	79	260	90	1159	<b>8128232</b>	<b>EHAM-MA-L9-120-L9-90-S</b>

Accessories

**Adapter kit EHAM-MA-L9-...-S**

Material:  
Anodised wrought aluminium alloy  
RoHS-compliant

- For axis/axis mounting with adapter plate
- Mounting option: base axis with one-size-down assembly axis
- When motors are mounted using parallel kits, this may lead to interfering contours. In this case, height compensation is required for the adapter plate (download CAD data → [www.festo.com](http://www.festo.com))
- Overview of mounting options → page 28

Combination matrix – Type C

Y-Z

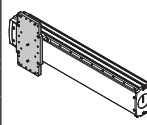
		Z-axis: Assembly axis ELGT-BS
	Size	120
Y-axis: Base axis ELGT-BS	160	8128231

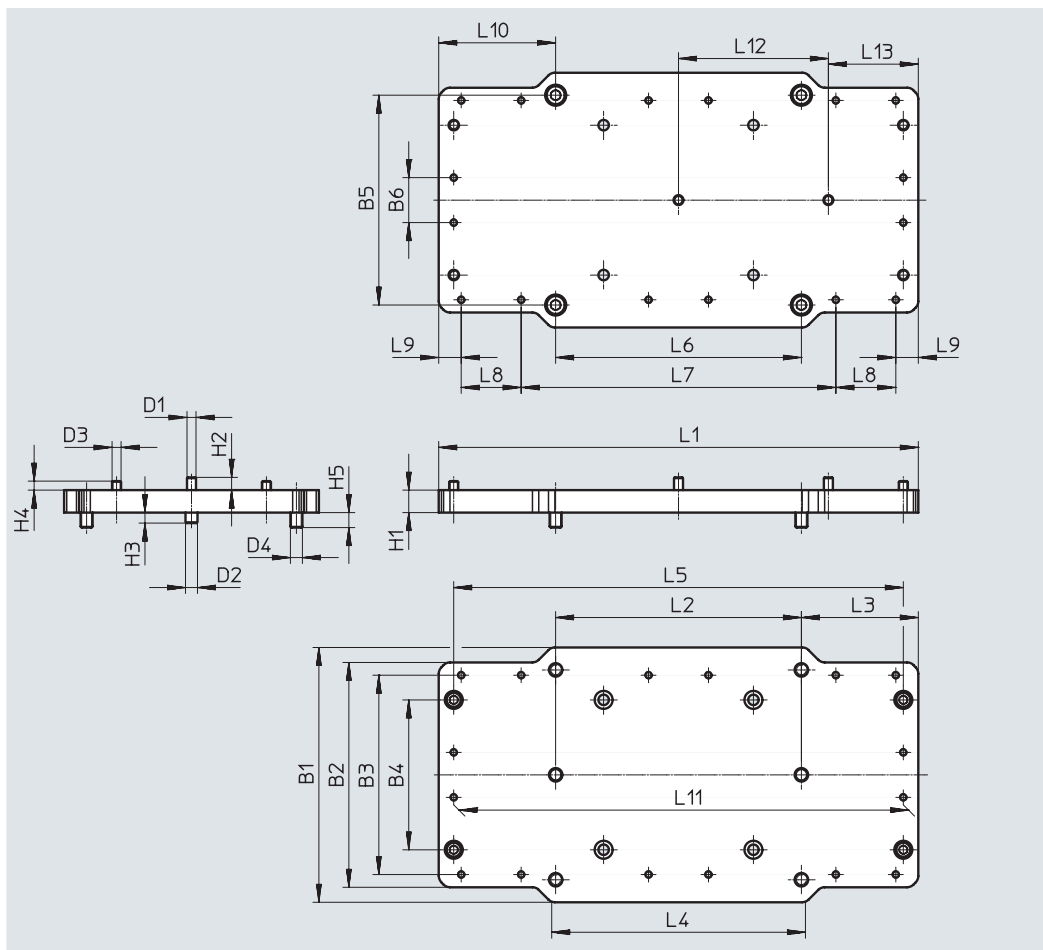



## Accessories

Dimensions and ordering data																		
For combination (size)	B1	B2	B3	B4	B5	B6	D1 ∅ h7	D2 ∅ h7	D3	D4	H1	H2	H3	H4	H5	L1	L2 ±0.02	L3
160/120	170	150	133	100	140	30	6	8	M6	M8	15	8.5	7	6	10	320	164	78

For combination (size)	L4	L5	L6	L7	L8	L9	L10	L11	L12 ±0.02	L13	Weight [g]	Part no.	Type
160/120	173.5	300	164	210	40	15	78	300	100	60	2136	8128231	EHAM-MA-L9-160-L9-120-S

Accessories

Adapter kit EHAM-MA-L9-...-L2-...

Material:

Anodised wrought aluminium alloy

RoHS-compliant

- For axis/axis mounting with adapter plate
- Mounting option: base axis with one-size-down assembly axis
- When motors are mounted using parallel kits, this may lead to interfering contours. In this case, height compensation is required for the adapter plate (download CAD data → [www.festo.com](http://www.festo.com))
- Overview of mounting options → page 28

Combination matrix – Type D  
Y-Z

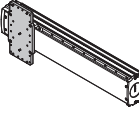
		Z-axis:		
		Assembly axis ELGC	80	Assembly axis EGSC
	Size	60	80	60
Y-axis:	90	8128230	8128229	8128230
Base axis ELGT-BS	120	-	8128228	-

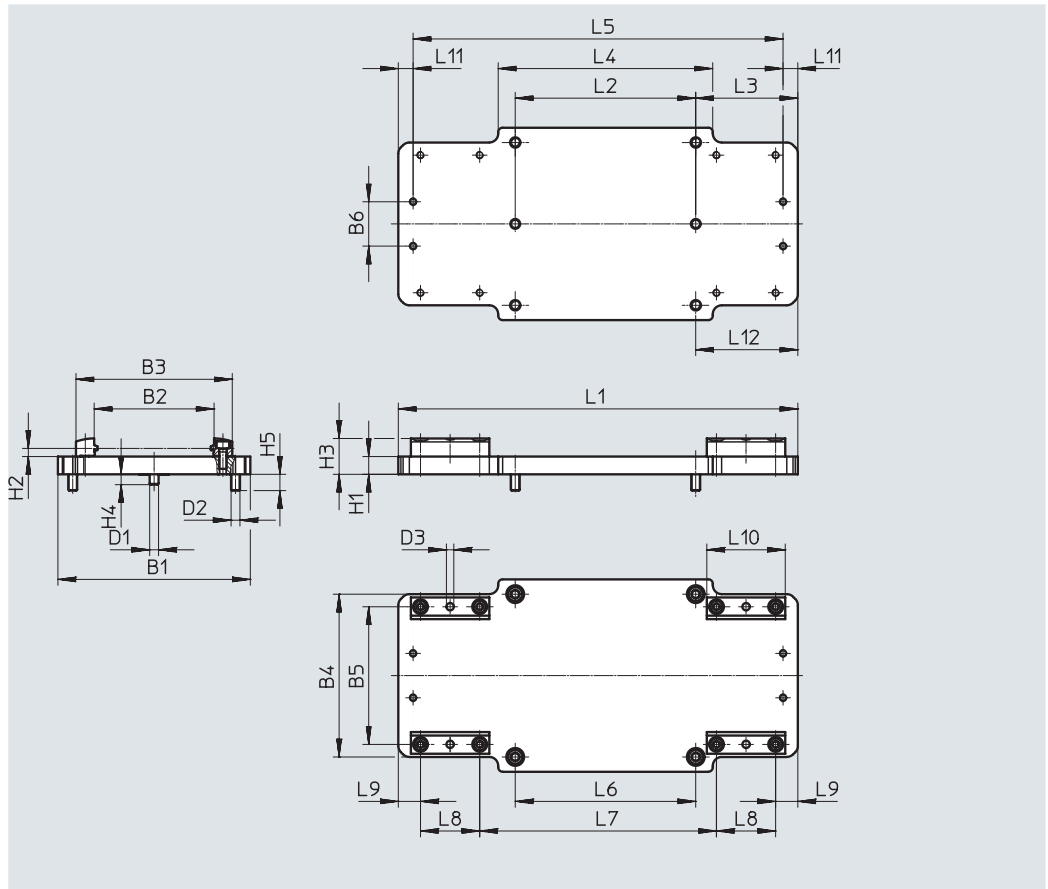
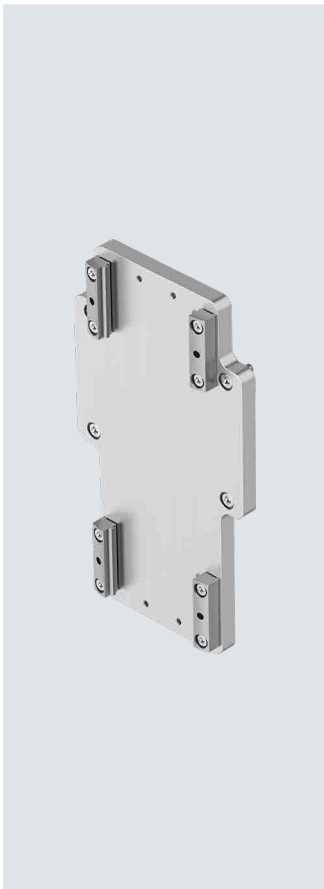

## Accessories

Dimensions and ordering data																	
For combination (size)	B1	B2	B3	B4	B5	B6	D1 ∅ h7	D2	D3 ∅	H1	H2 ±0.1	H3	H4	H5	L1	L2 ±0.02	L3
90/60	150	61	85.6	90	73	30	5	M6	5	12	5.5	24.2	5	11	250	90	55
90/80	150	81	105.6	110	93	30	5	M6	5	12	5.5	24.2	5	11	270	90	55
120/80	130	81	105.6	110	93	30	6	M6	5	12	5.5	24.2	7	11	270	122	69

For combination (size)	L4	L5	L6	L7	L8	L9	L10	L11	L12	Weight [g]	Part no.	Type
90/60	110	230	90	140	40	15	53	10	55	1053	<b>8128230</b>	<b>EHAM-MA-L9-90-L2-60</b>
90/80	110	250	90	160	40	15	53	10	55	1215	<b>8128229</b>	<b>EHAM-MA-L9-90-L2-80</b>
120/80	145	250	122	160	40	15	53	10	69	1170	<b>8128228</b>	<b>EHAM-MA-L9-120-L2-80</b>

## Accessories

-  - Note

Depending on the combination of motor and drive, it may not be possible to reach the maximum feed force of the drive.

When using parallel kits, the no-load driving torque of the particular kit must be taken into consideration.

## Permissible axis/motor combinations with axial kit – Without gear unit

Data sheets → Internet: eamm-a

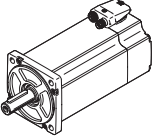
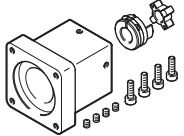
Motor <sup>1)</sup>	Axial kit	
	 <ul style="list-style-type: none"> <li>Kits for third-party motors → Internet: eamm-a</li> </ul>	
Type	Part no.	Type
<b>ELGT-BS-90 ... 160</b>		
<b>With servo motor</b>		
EMMT-AS-60-...	4824833	EAMM-A-T46-60P
EMME-AS-60-...	4824833	EAMM-A-T46-60P
EMME-AS-80-...	4624170	EAMM-A-T46-80P
EMME-AS-100-...	4624227	EAMM-A-T46-100A
<b>With stepper motor</b>		
EMMS-ST-87-...	4048771	EAMM-A-T46-87A
<b>With integrated drive</b>		
EMCA-EC-67-...	8084495	EAMM-A-T46-67A

1) The input torque must not exceed the maximum permissible transferable torque of the axial kit.

## Permissible axis/motor combinations with parallel kit

Data sheets → Internet: eamm-u

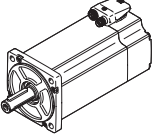
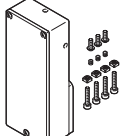
Motor/gear unit <sup>1)</sup>	Parallel kit	
	 <ul style="list-style-type: none"> <li>The kit can be mounted in all directions</li> <li>Kits for third-party motors → Internet: eamm-u</li> </ul>	
Type	Part no.	Type
<b>ELGT-BS-90 ... 120</b>		
<b>With servo motor</b>		
EMMT-AS-60-...	4824069	EAMM-U-87-T46-60P-114
EMME-AS-60-...	4824069	EAMM-U-87-T46-60P-114
EMME-AS-80-...	4822696	EAMM-U-87-T46-80P-114
<b>With stepper motor</b>		
EMMS-ST-87-...	4819278	EAMM-U-87-T46-87A-114
<b>With integrated drive</b>		
EMCA-EC-67-...	8084496	EAMM-U-87-T46-67A-114
<b>ELGT-BS-160</b>		
<b>With servo motor</b>		
EMME-AS-60-...	8126161	EAMM-U-87-T46-60P-147
EMME-AS-80-...	8126167	EAMM-U-87-T46-80P-147
<b>With stepper motor</b>		
EMMS-ST-87-...	8126170	EAMM-U-87-T46-87A-147
<b>With integrated drive</b>		
EMCA-EC-67-...	8126164	EAMM-U-87-T46-67A-147

1) The input torque must not exceed the max. permissible transferable torque of the parallel kit.

## Accessories

### Profile mounting EAHF-L2-...-P

Material:

Anodised wrought aluminium alloy

RoHS-compliant

- For mounting the axis on the side of the profile.

The profile mounting can be attached to the mounting surface using the drilled hole in the centre.

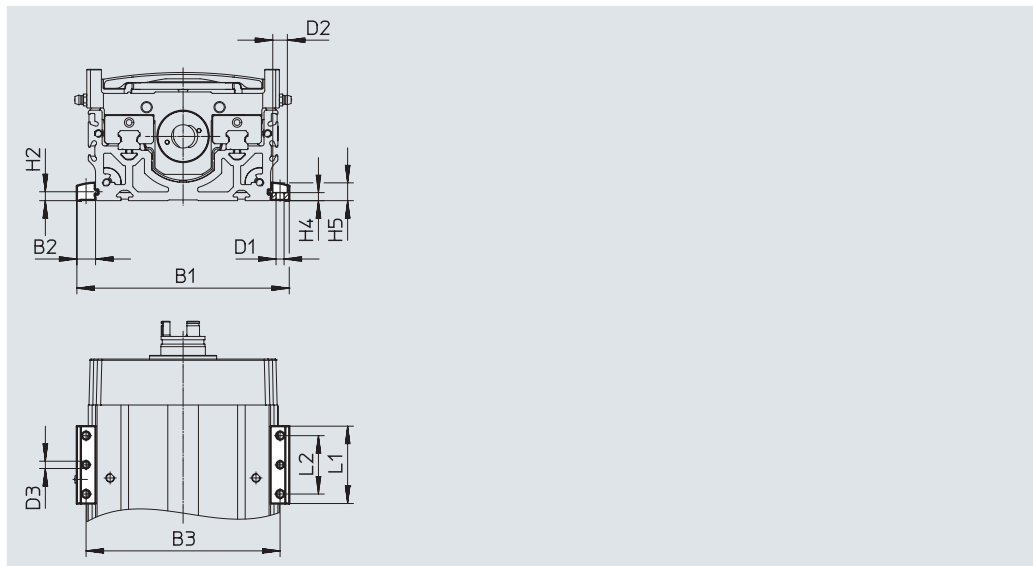

#### Dimensions and ordering data

For size	B1	B2	B3	D1 ∅ H13	D2 ∅ H13	D3 ∅	H2	H4
90	115.6	12.8	103	5.5	10	5	6.1	5.5
120	145.6	12.8	133	5.5	10	5	6.1	5.5
160	185.6	12.8	173	5.5	10	5	6.1	5.5

For size	H5	L1	L2	Weight [g]	Part no.	Type
90	12.2	53	40	35	4835728	EAHF-L2-45-P
120	12.2	53	40	35	4835728	EAHF-L2-45-P
160	12.2	53	40	35	4835728	EAHF-L2-45-P

## Accessories

### Profile mounting EAHF-L2-...-P-S

Material:

Anodised wrought aluminium alloy

RoHS-compliant

- For mounting the axis on the side of the profile

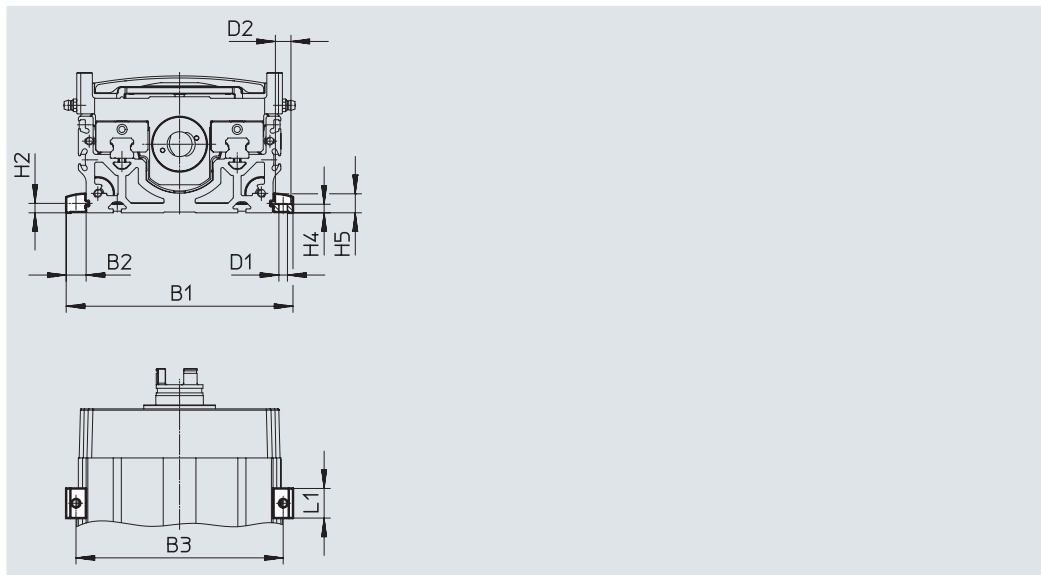
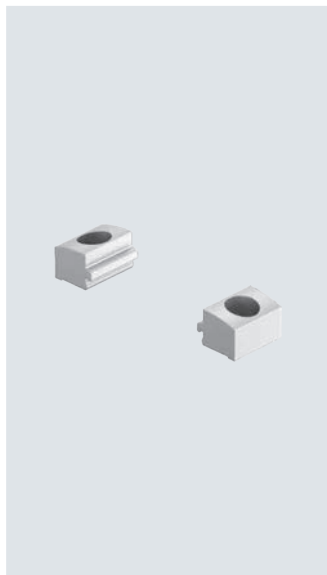

#### Dimensions and ordering data

For size	B1	B2	B3	D1 ∅ H13	D2 ∅ H13	H2 ±0.1
90	115.6	12.8	103	5.5	10	6.1
120	145.6	12.8	133	5.5	10	6.1
160	185.6	12.8	173	5.5	10	6.1

For size	H4	H5	L1	Weight [g]	Part no.	Type
90	5.5	12.2	19	6	5184133	EAHF-L2-45-P-S
120	5.5	12.2	19	6	5184133	EAHF-L2-45-P-S
160	5.5	12.2	19	6	5184133	EAHF-L2-45-P-S

## Accessories

### Switch lug EAPM-L9-...-SLS

For sensing using inductive proximity switches SIES-8M

Material:

High-alloy steel

RoHS-compliant

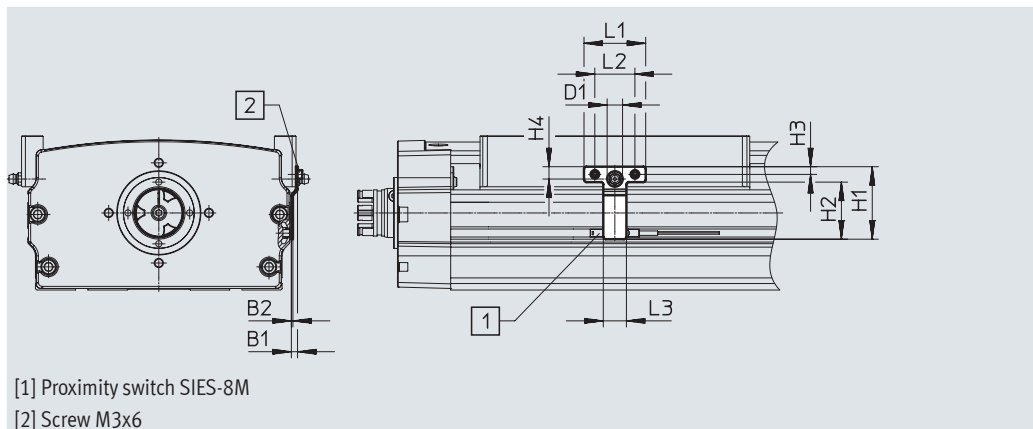

[1] Proximity switch SIES-8M

[2] Screw M3x6

#### Dimensions and ordering data

For size	B1	B2	B3	D1	H1	H2	H3
				∅			
90	5	1	5	–	61	51	5
120	–	1	5	10	48	38	5
160	4	1	5	10	47	37	5

For size	H4	L1	L2	L3	Weight [g]	Part no.	Type
90	–	32	20	15	6	<b>8119853</b>	<b>EAPM-L9-90-SLS</b>
120	8	40	26	15	10	<b>8119854</b>	<b>EAPM-L9-120-SLS</b>
160	8	40	26	15	10	<b>8119855</b>	<b>EAPM-L9-160-SLS</b>

Accessories

Switch lug EAPM-L9-...-SLE

Sensor bracket EAPM-L9-SHE

For sensing with third-party sensors  
(OMRON, series EE-SX674)

Material:

High-alloy steel

RoHS-compliant

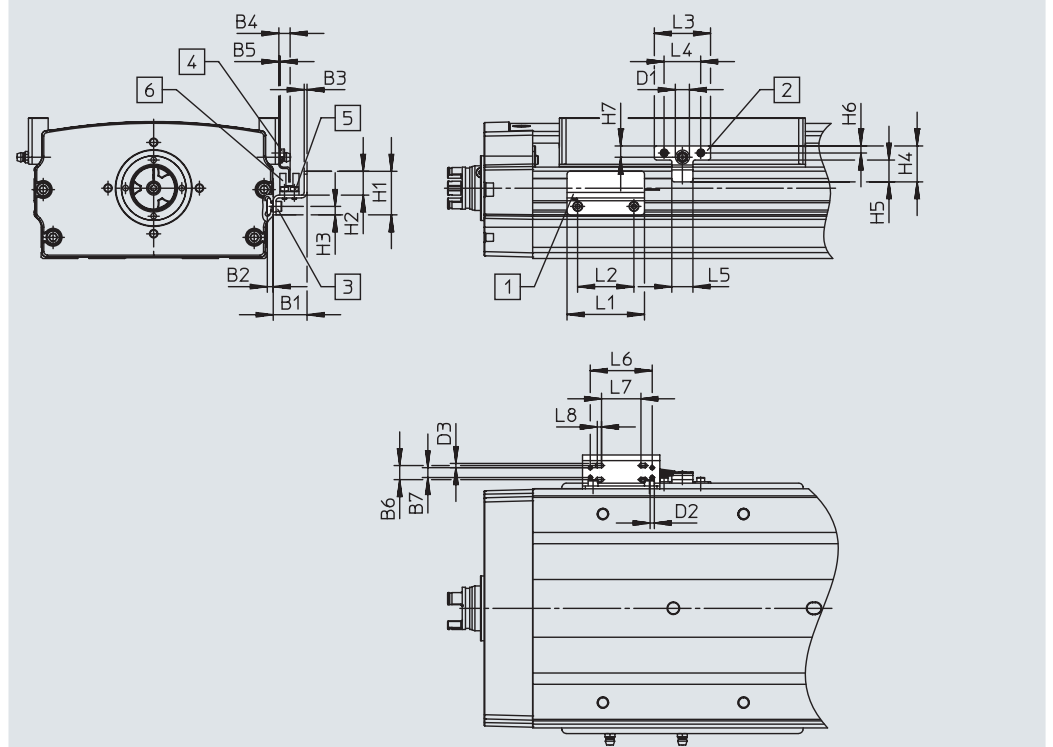
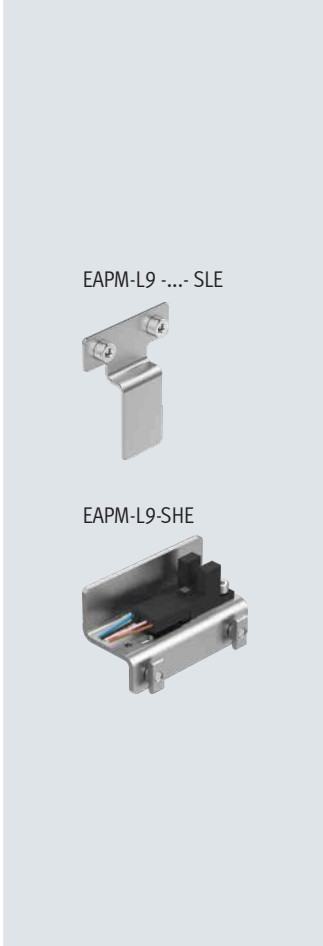

- [1] Sensor bracket EAPM-L9-SHE
- [2] Switch lug EAPM-L9-...-SLE
- [3] Screw M4x6
- [4] Screw M3x6
- [5] Screw M3x6
- [6] Optical sensor OMRON, series EE-SX674



Dimensions and ordering data

For size	B1	B2	B3	B4	B5	B6	B7	D1 ∅	D2	D3 ∅	H1	H2	H3	H4	H5	H6
90	24	4.2	2	7	1	10	7	-	M3	3	31	17	6	39	29	5
120	24	4.2	2	11	1	40	7	10	M3	3	31	17	6	25.5	15.5	5
160	24	4.2	2	8	1	40	7	10	M3	3	31	17	6	25.5	15.5	5
90... 160	24	4.2	2	-	1	-	7	-	M3	3	31	17	6	-	-	5



For size	H7	L1	L2	L3	L4	L5	L6	L7	L8	Weight	Part no.	Type
90	-	55	40	32	20	15	44	28	3	10	8120123	EAPM-L9-90-SLE
120	8	55	40	40	26	15	44	28	3	9	8120124	EAPM-L9-120-SLE
160	8	55	40	40	26	15	44	28	3	8	8120125	EAPM-L9-160-SLE
90... 160	-	55	40	-	-	15	44	28	3	55	8119255	EAPM-L9-SHE

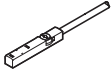
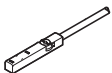
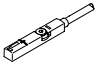
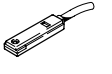
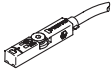
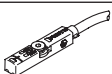

## Accessories

Ordering data – Proximity switches for T-slot, inductive							Data sheets → Internet: sies
	Type of mounting	Switching output	Electrical connection	Cable length [m]	Part no.	Type	
<b>N/O</b>							
	Inserted in the slot from above, flush with the cylinder profile	PNP	Cable, 3-wire	7.5	551386	SIES-8M-PS-24V-K-7.5-OE	
			Plug M8x1, 3-pin	0.3	551387	SIES-8M-PS-24V-K-0.3-M8D	
		NPN	Cable, 3-wire	7.5	551396	SIES-8M-NS-24V-K-7.5-OE	
			Plug M8x1, 3-pin	0.3	551397	SIES-8M-NS-24V-K-0.3-M8D	
<b>N/C</b>							
	Inserted in the slot from above, flush with the cylinder profile	PNP	Cable, 3-wire	7.5	551391	SIES-8M-PO-24V-K-7.5-OE	
			Plug M8x1, 3-pin	0.3	551392	SIES-8M-PO-24V-K-0.3-M8D	
		NPN	Cable, 3-wire	7.5	551401	SIES-8M-NO-24V-K-7.5-OE	
			Plug M8x1, 3-pin	0.3	551402	SIES-8M-NO-24V-K-0.3-M8D	
<b>Ordering data – Proximity switches for T-slot, magnetic reed</b>							Data sheets → Internet: sme
	Type of mounting	Switching output	Electrical connection	Cable length [m]	Part no.	Type	
<b>N/O</b>							
	Inserted in the slot from above, flush with the cylinder profile	Contacting	Cable, 3-wire	2.5	543862	SME-8M-DS-24V-K-2.5-OE	
				5.0	543863	SME-8M-DS-24V-K-5.0-OE	
			Cable, 2-wire	2.5	543872	SME-8M-ZS-24V-K-2.5-OE	
				Plug M8x1, 3-pin	0.3	543861	SME-8M-DS-24V-K-0.3-M8D
<b>N/C</b>							
	Inserted in the slot lengthwise, flush with the cylinder profile	Contacting	Cable, 3-wire	7.5	160251	SME-8-O-K-LED-24	
<b>Ordering data – Proximity switch for T-slot, magneto-resistive</b>							Data sheets → Internet: smt
	Type of mounting	Switching output	Electrical connection	Cable length [m]	Part no.	Type	
<b>N/O</b>							
	Inserted in the slot from above, flush with the cylinder profile, short design	PNP	Cable, 3-wire	2.5	574335	SMT-8M-A-PS-24V-E-2.5-OE	
			Plug M8x1, 3-pin	0.3	574334	SMT-8M-A-PS-24V-E-0.3-M8D	
<b>N/C</b>							
	Inserted in the slot from above, flush with the cylinder profile, short design	PNP	Cable, 3-wire	7.5	574340	SMT-8M-A-PO-24V-E-7.5-OE	
<b>Ordering data – Connecting cables</b>							Data sheets → Internet: nebu
	Electrical connection, left	Electrical connection, right	Cable length [m]	Part no.	Type		
	Straight socket, M8x1, 3-pin	Cable, open end, 3-wire	2.5	541333	NEBU-M8G3-K-2.5-LE3		
			5	541334	NEBU-M8G3-K-5-LE3		
	Angled socket, M8x1, 3-pin	Cable, open end, 3-wire	2.5	541338	NEBU-M8W3-K-2.5-LE3		
			5	541341	NEBU-M8W3-K-5-LE3		

## Accessories

Ordering data – Slot nuts					
	For size	Description	Part no.	Type	PU <sup>1)</sup>
Slot nut NST					
	90 ... 120	For mounting slot	150914	NST-5-M5	1
			8047843	NST-5-M5-10	10
			8047878	NST-5-M5-50	50
	160	For mounting slot	150915	NST-8-M6	1
			8047868	NST-8-M6-10	10
			8047869	NST-8-M6-50	50
	90 ... 160	Inserted in the slot from above, thread M4	8028500	ABAN-8-1M4-5-P2	2
			8028501	ABAN-8-1M4-5-P100	100

1) Packaging unit

# Festo - Your Partner in Automation



**1 Festo Inc.**  
5300 Explorer Drive  
Mississauga, ON L4W 5G4  
Canada

**Festo Customer Interaction Center**  
Tel: 1 877 463 3786  
Fax: 1 877 393 3786  
Email: [customer.service.ca@festo.com](mailto:customer.service.ca@festo.com)

**2 Festo Pneumatic**  
Av. Ceylán 3,  
Col. Tequesquináhuac  
54020 Tlalneantla,  
Estado de México

**Multinational Contact Center**  
01 800 337 8669  
[ventas.mexico@festo.com](mailto:ventas.mexico@festo.com)

**3 Festo Corporation**  
1377 Motor Parkway  
Suite 310  
Islandia, NY 11749

**Festo Customer Interaction Center**  
1 800 993 3786  
1 800 963 3786  
[customer.service.us@festo.com](mailto:customer.service.us@festo.com)

**4 Regional Service Center**  
7777 Columbia Road  
Mason, OH 45040

Connect with us



[www.festo.com/socialmedia](http://www.festo.com/socialmedia)



[www.festo.com](http://www.festo.com)

Subject to change