

Servo motors EMMB-AS

FESTO



Key features

Everything from a single source

Motors EMMB-AS

→ Page 4



- Brushless, permanently excited synchronous servo motors
- Reliable, dynamic, precise
- Digital absolute displacement encoder with single turn, multi-turn optional
- Optimised connection technology
- Winding variants
 - For single-phase motor controller
 - Optimised for rotational speed
- Holding brake

Gear unit EMGA-EAS/-SAS

→ Page 10



- Low-backlash planetary gear
- Gear ratio $i = 3$ and 5 , available from stock
- Life-time lubrication
- Degree of protection: IP54
- Other gear unit types, ratios, designs and versions on request

Servo drive CMMT-AS

→ Internet: cmm



- Universal servo drive for synchronous servo motors
- Integrated EMC filters
- Integrated brake chopper
- Integrated braking resistor
- Integrated safety functions
- Position controller
- Speed controller
- Force controller
- Range of control functions
- Interfaces:
 - EtherCAT
 - PROFINET

Motor, encoder and connecting cables NEBM

→ Page 11

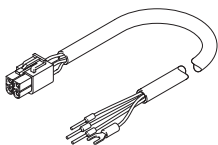

- Suitable for energy chains
- Connection technology on motor side with degree of protection to IP20
- Can be used in a wide temperature range

Axial and parallel kits EAMM

→ Internet: eamm



- Specific kits for all electromechanical axes from Festo
- Each kit includes the relevant necessary coupling housing, couplings and motor flange as well as all screws
- Optionally with degree of protection IP65

Type codes

001	Series	
EMMB	Motor	

002	Motor type	
AS	AC synchronous	

003	Flange size, motors	
40	40	
60	60	
80	80	

004	Performance class	
01	100 W	
02	200 W	
04	400 W	
07	750 W	

005	Output shaft	
	Smooth shaft	
K	Shaft to DIN 6885	

006	Electrical connection	
S	Straight plug	

007	Cable length [cm]	
30	30 cm	

008	Measuring unit	
S	Absolute encoder, single turn	
M	Absolute encoder, multi-turn	

009	Brake	
	None	
B	With brake	

Data sheet



Note
Motors and motor controllers from Festo have been specially designed to be used together. Trouble-free operation cannot be guaranteed in combination with third-party controllers.



Technical data					
Flange size		40	60	80	
Performance class		01	02	04	07
Motor					
Nominal voltage	[V DC]	300	300	300	300
Nominal current	[A]	1.3	1.4	2.4	3.8
Continuous stall current	[A]	1.43	1.5	2.6	4.2
Peak current	[A]	3.9	4.2	7.2	11.4
Nominal power	[W]	100	200	400	750
Nominal torque	[Nm]	0.32	0.64	1.27	2.39
Peak torque	[Nm]	0.96	1.92	3.81	7.17
Stall torque	[Nm]	0.352	0.7	1.4	2.63
Nominal rotary speed	[rpm]	3000	3000	3000	3000
Max. rotational speed	[rpm]	6000	6000	6000	5000
Motor constant	[Nm/A]	0.265	0.48	0.562	0.662
Voltage constant (phase-to-phase)	[mV/min]	16.2	29	34	40
Number of pole pairs		5	3	3	3
Winding resistance	[Ω]	7.9	11.2	5.8	2.1
Winding inductance	[mH]	10.5	20.9	11.5	10.5
Total output moment of inertia					
Without brake	[kgcm ²]	0.059	0.214	0.405	0.942
With brake	[kgcm ²]	0.063	0.234	0.425	0.978
Shaft load at nominal rotary speed					
Radial	[N]	120	180	180	335
Axial	[N]	60	90	90	167.5
Brake					
Operating voltage	[V DC]	24	24	24	24
Power	[W]	5.9	7.2	7.2	11.5
Holding torque	[Nm]	0.32	1.3	1.3	3.2
Mass moment of inertia	[kgcm ²]	0.004	0.004	0.004	0.012
Weights [kg]					
Flange size		40	60	80	
Performance class		01	02	04	07
Without brake		0.8	1.1	1.6	2.8
With brake		1	1.6	2.1	3.5

Data sheet

Technical data – Encoder			
Measuring unit		Absolute, single turn	Absolute, multi-turn
Interface/protocol		Nikon A format	
Operating voltage	[V DC]	5 (±5%)	
Operating voltage range	[V DC]	4.75 ... 5.25	
Measuring principle		Optical	
Position values per revolution		1048576	
Resolution	[bit]	20	
Absolute detectable revolutions		1	65536, 16 bits
System accuracy of angle measurement	[arcsec]	±120	
Operating and environmental conditions			
Flange size		40	60 80
Conforms to standard		IEC60034	
Degree of protection			
Motor shaft (without rotary shaft seal)		IP40	
Motor shaft (with rotary shaft seal) ¹⁾		IP54	
Motor housing (without connection technology)		IP65	
Ambient temperature	[°C]	-15 ... +40	
Note on ambient temperature		Up to 60 °C with derating of -1.5% per degree Celsius	
Storage temperature	[°C]	-20 ... +55	
Max. setup altitude	[m]	4000	
Note on max. setup altitude		As of 1000 m only with derating of -1.0% per 100 m	
Insulation class		F (up to 155 °C)	
Temperature monitoring		Digital motor temperature transmission via Nikon A format	
Rating class to EN 60034-1		S1 (continuous operation)	
Relative humidity	[%]	0 ... 90 (non-condensing)	
Vibration resistance		Transport application test with severity level 2 to FN 942017-4 and EN 60068-2-6	
Shock resistance		Shock test with severity level 2 to FN 942017-5 and EN 60068-2-27	
CE marking (see declaration of conformity)		To EU Low Voltage Directive To EU-EMC Directive ²⁾ To EU RoHS Directive	
UKCA marking (see declaration of conformity)		To UK instructions for EMC To UK RoHS instructions To UK regulations for electrical equipment	
Certification		c UL us - Recognized (OL)	
Note on materials		RoHS-compliant Contains paint-wetting impairment substances	

1) The rotary shaft seal is included in the scope of delivery of the motor.

2) For information about the area of use, see the EC declaration of conformity at: www.festo.com/sp → Certificates.

If the devices are subject to usage restrictions in residential, commercial or light-industrial environments, further measures for the reduction of the emitted interference may be necessary.

Data sheet

Pin allocation – Motor side

Motor Brake

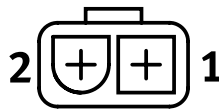
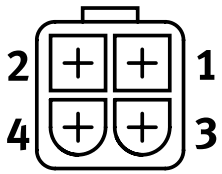

PIN	Function
1	U Phase
2	V Phase
3	W Phase
4	PE Protective earthing

PIN	Function
1	BR+
2	BR-

Encoder

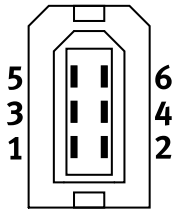

PIN	Function
1	Vcc
2	GND
3	BAT+
4	BAT-
5	SD+
6	SD-

Data sheet

Torque M as a function of rotational speed n

Flange size 40

Performance class 01

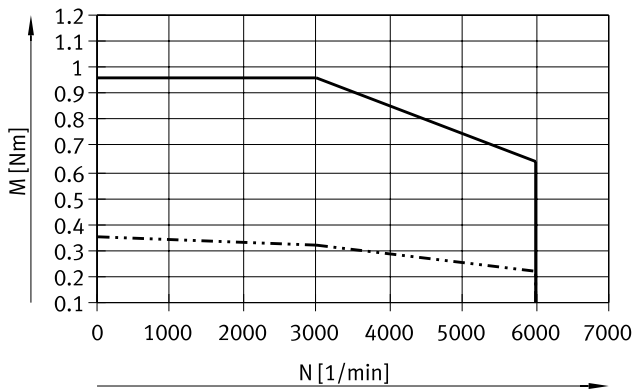

Flange size 60

Performance class 02

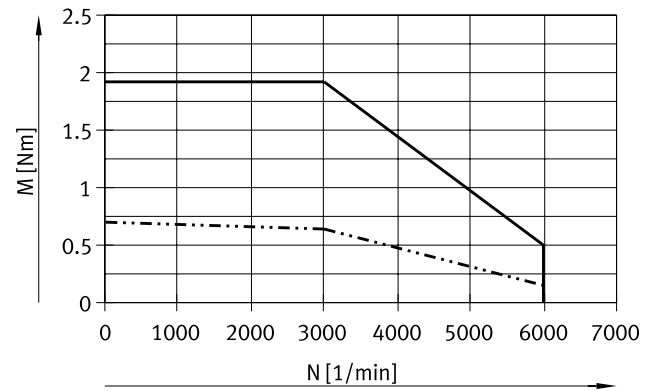

Flange size 60

Performance class 04

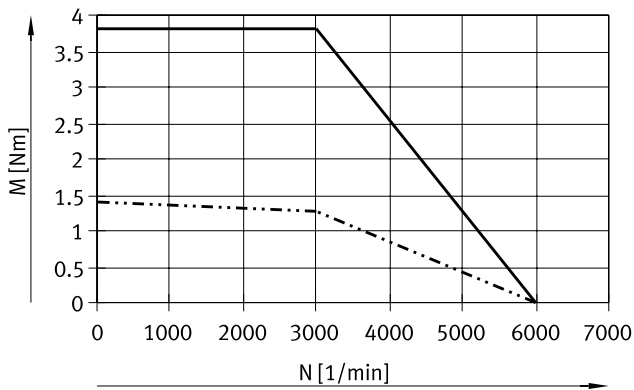

Flange size 80

Performance class 07

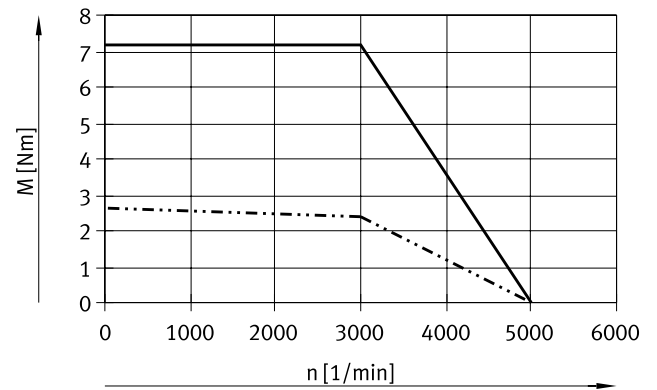

- Peak torque
- - - - - Nominal torque

Note
Typical motor characteristic curve with nominal voltage and optimal motor controller.

Data sheet

Dimensions

Download CAD data → www.festo.com

EMMB-AS-40

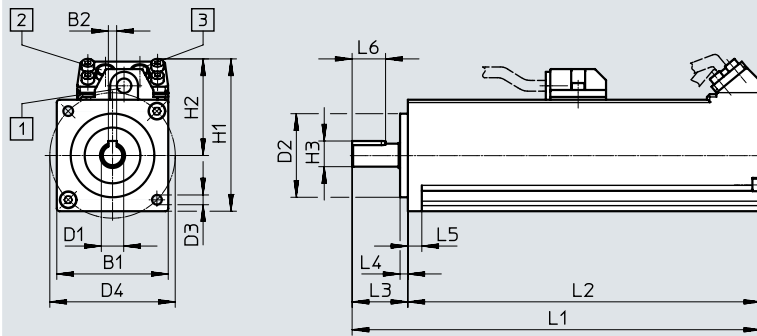

- [1] Electrical connection for motor
- [2] Electrical connection for brake
- [3] Electrical connection for encoder

Type	Featherkey	B1	B2	D1 ∅	D2 ∅	D3 ∅	D4 ∅
EMMB-AS-40	Without	40	-	8	30	3.5	45
	With		3				

Type	Featherkey	H1 max.	H2 max.	H3	L1		L2	
					Without brake +1.5/-1.7	With brake +1.5/-1.7	Without brake ±1	With brake ±1
EMMB-AS-40	Without	70	50	-	116.6	146.6	96.6	126.6
	With			9.7				

Type	Featherkey	L3	L4	L5	L6
EMMB-AS-40	Without	20	2.8	5	-
	With				12

Data sheet

Dimensions

EMMB-AS-60/-80

Download CAD data → www.festo.com

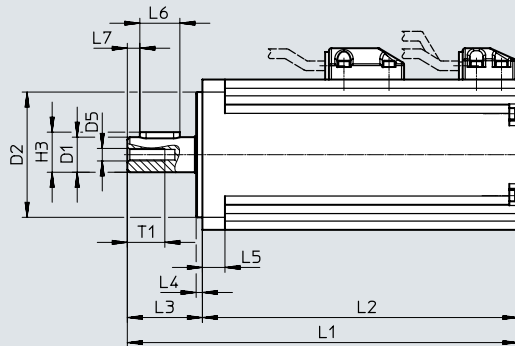
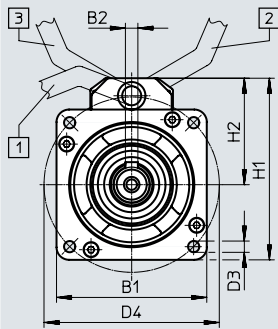

EMMB-AS-80

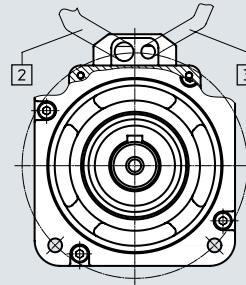

- [1] Electrical connection for motor
- [2] Electrical connection for encoder
- [3] Electrical connection for brake

Type	Featherkey	B1	B2	D1 ∅	D2 ∅	D3 ∅	D4 ∅ ±0.1	D5 ∅
EMMB-AS-60-02	Without	60	-	14 _{-0.011}	50 _{-0.016}	4.5	70	5
	With		5					
EMMB-AS-60-04	Without	60	-	14 _{-0.011}	50 _{-0.016}	4.5	70	5
	With		5					
EMMB-AS-80-07	Without	80	-	19 _{-0.013}	70 _{-0.02}	5.5	90	6
	With		6					

Type	Featherkey	H1	H2	H3 -0.13	L1		L2	
					Without brake	With brake	Without brake ±1.5	With brake ±1.5
EMMB-AS-60-02	Without	72.5	42.5	16	124 _{+2.5}	156 _{+2.5}	94	126
	With							
EMMB-AS-60-04	Without	72.5	42.5	16	150 _{+2.5}	182 _{+2.5}	120	152
	With							
EMMB-AS-80-07	Without	94	54	21.5	164 _{+2.4/-2}	193.5 _{+2.4/-2}	129.5	159
	With							

Type	Featherkey	L3	L4	L5 ±1	L6	L7	T1
EMMB-AS-60-02	Without	30 _{±1}	2.5	9	-	-	15
	With				16	5	
EMMB-AS-60-04	Without	30 _{±1}	2.5	9	-	-	15
	With				16	5	
EMMB-AS-80-07	Without	34.5 _{+0.9/-0.5}	3	10	-	-	15
	With				22	4	

Data sheet

Ordering data				Measuring unit		Variant		Part no.	Type
Nominal power [W]				Encoder, single turn	Encoder, multi-turn	With featherkey	With brake		
100	200	400	750						
Flange size 40									
■				■				8097163	EMMB-AS-40-01-S30S
■				■			■	8097164	EMMB-AS-40-01-S30SB
■				■		■		8097165	EMMB-AS-40-01-K-S30S
■				■		■	■	8097166	EMMB-AS-40-01-K-S30SB
■					■			8097167	EMMB-AS-40-01-S30M
■					■		■	8097168	EMMB-AS-40-01-S30MB
■					■	■		8097169	EMMB-AS-40-01-K-S30M
■					■	■	■	8097170	EMMB-AS-40-01-K-S30MB
Flange size 60									
	■			■				8097171	EMMB-AS-60-02-S30S
	■			■			■	8097172	EMMB-AS-60-02-S30SB
	■			■		■		8097173	EMMB-AS-60-02-K-S30S
	■			■		■	■	8097174	EMMB-AS-60-02-K-S30SB
	■				■			8097175	EMMB-AS-60-02-S30M
	■				■		■	8097176	EMMB-AS-60-02-S30MB
	■				■	■		8097177	EMMB-AS-60-02-K-S30M
	■				■	■	■	8097178	EMMB-AS-60-02-K-S30MB
		■		■				8097179	EMMB-AS-60-04-S30S
		■		■			■	8097180	EMMB-AS-60-04-S30SB
		■		■		■		8097181	EMMB-AS-60-04-K-S30S
		■		■		■	■	8097182	EMMB-AS-60-04-K-S30SB
		■			■			8097183	EMMB-AS-60-04-S30M
		■			■		■	8097184	EMMB-AS-60-04-S30MB
		■			■	■		8097185	EMMB-AS-60-04-K-S30M
		■			■	■	■	8097186	EMMB-AS-60-04-K-S30MB
Flange size 80									
			■	■				8097187	EMMB-AS-80-07-S30S
			■	■			■	8097188	EMMB-AS-80-07-S30SB
			■	■		■		8097189	EMMB-AS-80-07-K-S30S
			■	■		■	■	8097190	EMMB-AS-80-07-K-S30SB
			■		■			8097191	EMMB-AS-80-07-S30M
			■		■		■	8097192	EMMB-AS-80-07-S30MB
			■		■	■		8097193	EMMB-AS-80-07-K-S30M
			■		■	■	■	8097194	EMMB-AS-80-07-K-S30MB

Accessories

Ordering data – Gear unit

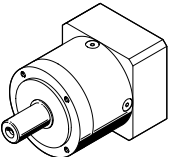
	For motor flange size	Gear ratio	Part no.	Type
		40P	3	2297684
5			2297685	EMGA-40-P-G5-EAS-40
60P		3	2297686	EMGA-60-P-G3-EAS-60
		5	2297687	EMGA-60-P-G5-EAS-60
80P		3	2297690	EMGA-80-P-G3-EAS-80
		5	2297691	EMGA-80-P-G5-EAS-80

Accessories

Technical data – Cables			
Designation		Motor cable	Encoder cable
Type		NEBM-H6G4-E...	NEBM-REG6-E...
Cable composition		4x 0.79 mm ²	2x 0.51 mm ² + 4x 0.205 mm ²
Cable diameter	[mm]	7.3	7.4
Pollution degree		3	3
Bending radius			
Fixed cable installation	[mm]	≥ 55	≥ 55
Flexible cable installation	[mm]	≥ 55	≥ 55
Ambient temperature			
Standard	[°C]	-25 ... +90	-40 ... +80
Flexible cable installation	[°C]	-25 ... +90	-10 ... +80
Cable characteristic		Suitable for energy chains	Suitable for energy chains
Degree of protection		IP20 (in mounted state)	IP20 (in mounted state)
CE marking (see declaration of conformity)		To EU Low Voltage Directive	To EU Low Voltage Directive
Material		PVC	PVC
Note on materials		RoHS-compliant	RoHS-compliant
		Contains paint-wetting impairment substances	Contains paint-wetting impairment substances

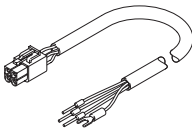
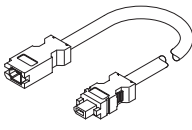
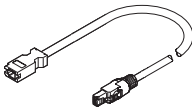
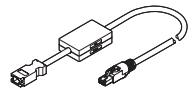
Ordering data			
	Cable length [m]	Part no.	Type
Motor cable			
	2.5	5219197	NEBM-H6G4-E-2.5-Q13N-LE4
	5	5219198	NEBM-H6G4-E-5-Q13N-LE4
	7.5	5219199	NEBM-H6G4-E-7.5-Q13N-LE4
	10	5219200	NEBM-H6G4-E-10-Q13N-LE4
	15	8097203	NEBM-H6G4-E-15-Q13N-LE4
	20	8097204	NEBM-H6G4-E-20-Q13N-LE4
	25	8097205	NEBM-H6G4-E-25-Q13N-LE4
Encoder cable			
	2.5	5219213	NEBM-REG6-E-2.5-Q14N-REG6
	5	5219214	NEBM-REG6-E-5-Q14N-REG6
	7.5	5219215	NEBM-REG6-E-7.5-Q14N-REG6
	10	5219216	NEBM-REG6-E-10-Q14N-REG6
	15	8097200	NEBM-REG6-E-15-Q14N-REG6
	20	8097201	NEBM-REG6-E-20-Q14N-REG6
	25	8097202	NEBM-REG6-E-25-Q14N-REG6
Adapter for encoder cable (absolutely essential)			
	For single turn with CMMT-AS		
	0.5	8097197	NEFM-REG6-K-0.5-R3G8
	For multi-turn with CMMT-AS ¹⁾		
	0.5	8097195	NEFM-REG6-K-0.5-B-R3G8
	For multi-turn with CMM-B-AS ¹⁾		
0.5	8097196	NEFM-REG6-K-0.5-B-REG6	

1) The battery is not included in the scope of delivery

Accessories

Technical data – Cables		
Designation	Connecting cable for brake	
Type	NEBM-H7G2-E-...	
Cable composition	2x 0.51 mm ²	
Cable diameter [mm]	5.1	
Pollution degree	3	
Bending radius		
Fixed cable installation [mm]	≥ 21	
Flexible cable installation [mm]	≥ 51	
Ambient temperature		
Standard [°C]	-40 ... +80	
Flexible cable installation [°C]	-10 ... +80	
Cable characteristic	Suitable for energy chains	
Degree of protection	IP20 (in mounted state)	
CE marking (see declaration of conformity)	To EU Low Voltage Directive	
Material	PVC	
Note on materials	RoHS-compliant	
	Contains paint-wetting impairment substances	

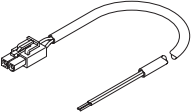
Ordering data			
	Cable length [m]	Part no.	Type
Connecting cable for brake			
	2.5	5219205	NEBM-H7G2-E-2.5-Q14N-LE2
	5	5219206	NEBM-H7G2-E-5-Q14N-LE2
	7.5	5219207	NEBM-H7G2-E-7.5-Q14N-LE2
	10	5219208	NEBM-H7G2-E-10-Q14N-LE2
	15	8097206	NEBM-H7G2-E-15-Q14N-LE2
	20	8097207	NEBM-H7G2-E-20-Q14N-LE2
	25	8097208	NEBM-H7G2-E-25-Q14N-LE2

Festo - Your Partner in Automation



1 Festo Inc.
5300 Explorer Drive
Mississauga, ON L4W 5G4
Canada

Festo Customer Interaction Center
Tel: 1 877 463 3786
Fax: 1 877 393 3786
Email: customer.service.ca@festo.com

2 Festo Pneumatic
Av. Ceylán 3,
Col. Tequesquináhuac
54020 Tlalnepantla,
Estado de México

Multinational Contact Center
01 800 337 8669
ventas.mexico@festo.com

3 Festo Corporation
1377 Motor Parkway
Suite 310
Islandia, NY 11749

Festo Customer Interaction Center
1 800 993 3786
1 800 963 3786
customer.service.us@festo.com

4 Regional Service Center
7777 Columbia Road
Mason, OH 45040

Connect with us



www.festo.com/socialmedia



www.festo.com

Subject to change