

## Rotary modules ERMB, electric

**FESTO**

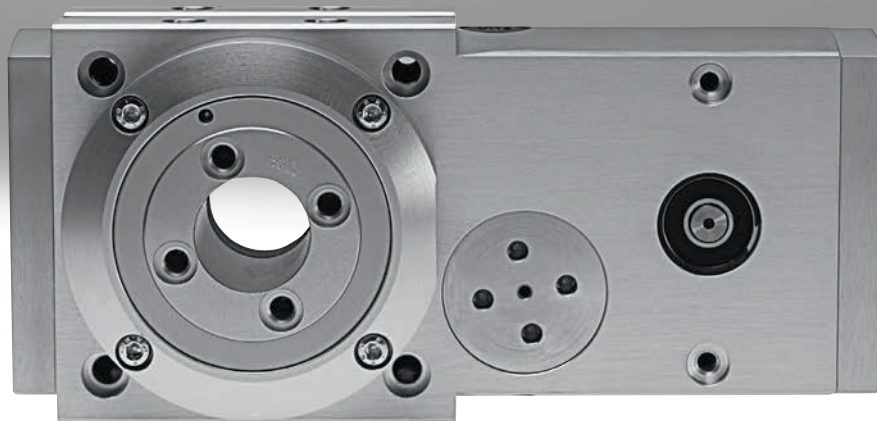

## Characteristics

### At a glance

The rotary module ERMB facilitates unlimited and flexible rotation angles. The motor's power is transmitted to the output pinion via a recirculating toothed belt with a specific transmission ratio. The drive and output pinions run on separate bearings. The toothed belt is pretensioned at the factory using an eccentric tensioning roller.

### Advantages:

- Stable output shaft bearings
- Pretensioned toothed belt means low backlash
- Compact design

### The technology in detail

- [1] Interface with the motor, via axial kit
- [2] Interface for mounting
- [3] Mounting for proximity switches SIEN in the retaining ring
- [4] Output interface

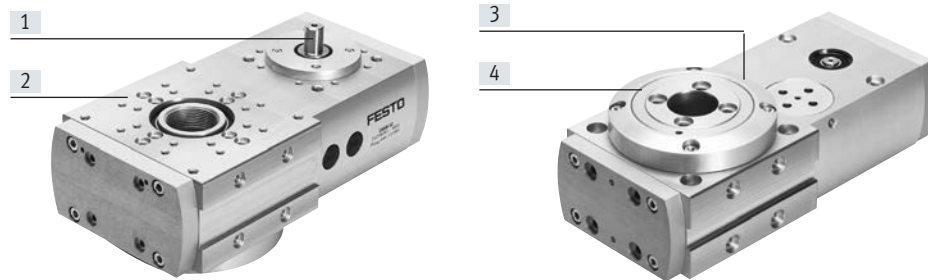

### Sensing kit EAPS as an accessory

→ Page 23

With the sensing kit, the angle of rotation can be monitored using adjustable cams. The kit can also be used for reference checking.

- [1] Trip cam support
- [2] Proximity switches SIEN
- [3] Sensor bracket
- [4] Housing

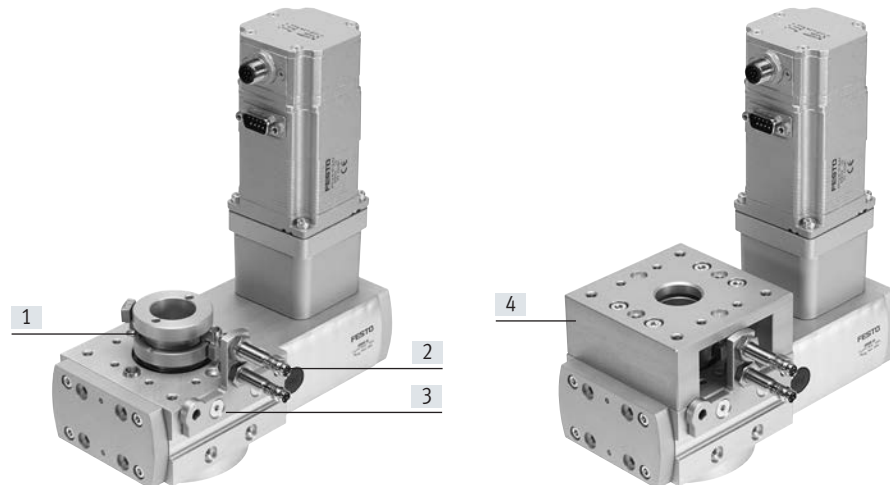

### Mounting and installation options

#### Mounting option

The rotary module can be mounted on 6 sides.

#### Installation option

As a front unit

As a rotary table in a plate

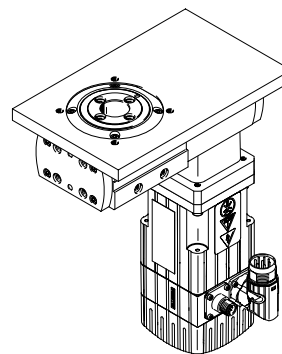
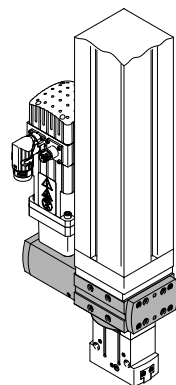
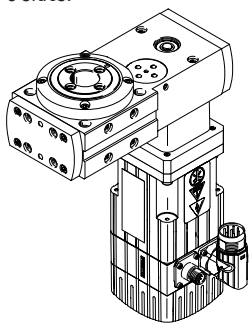

## Characteristics

### Total system comprising rotary module, motor and axial kit

Rotary module

→ Page 6

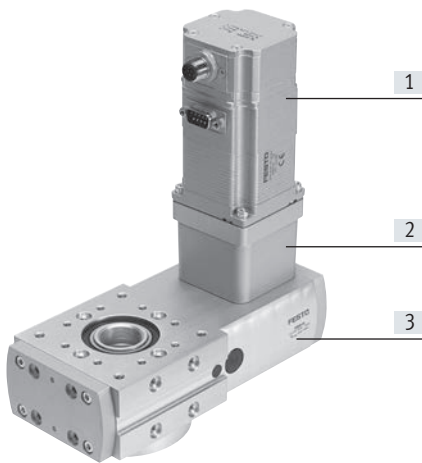

- [1] Motor
- [2] Axial kit
- [3] Rotary module

### Motors

→ Page 18



- Servo motor EMME-AS, EMMS-AS
- Stepper motor EMMS-ST
- Integrated drive EMCA



#### Note

A range of specially adapted and matching complete solutions is available for the rotary module ERMB and the motors.

### Motor controllers

Data sheets → Internet: motor controller



- Servo motor controller CMMP-AS
- Stepper motor controller CMMT-ST

### Axial kit

→ Page 18



Kit comprising:

- Motor flange
- Coupling housing
- Coupling
- Screws

Peripherals overview

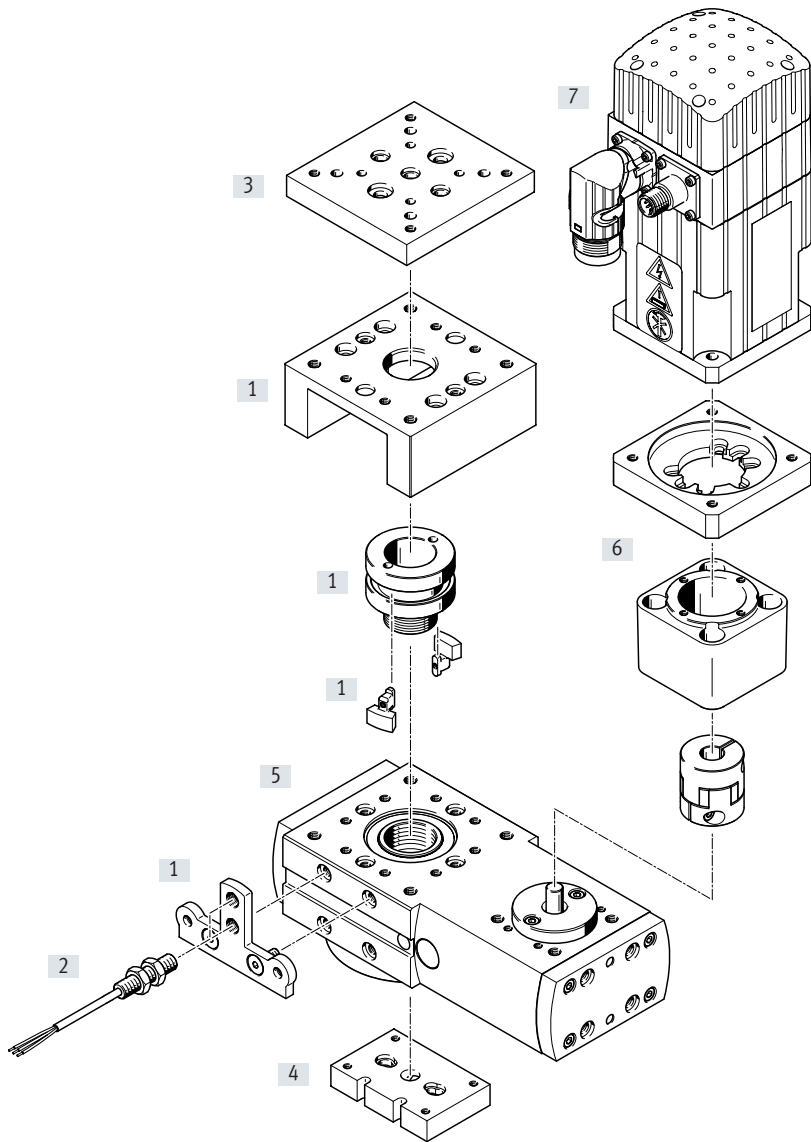

## Peripherals overview and type codes

Accessories			
	Type	Description	→ Page/Internet
[1]	Sensing kit EAPS	For indicating impermissible angles of rotation, i.e. obstacles or areas that cannot be approached can be sensed using proximity switches (comprising: housing, trip cam support, 2 cams and sensor bracket)	23
[2]	Proximity switch SIEN	For use as a signal or safety check	23
[3]	Adapter kit	Interface between the rotary module and drive (the rotary module can be mounted on a drive with or without a sensing kit)	adapter kit
[4]	Adapter kit	Interface between the rotary module and gripper	adapter kit
[5]	Rotary module ERMB	Facilitates unlimited and flexible rotation angles	23
[6]	Axial kit EAMM-A	For axial motor mounting (consisting of: coupling, coupling housing and motor flange)	18
[7]	Motor EMMS, EMME, EMCA	<ul style="list-style-type: none"> <li>• Motors specially matched to the axis, with or without brake</li> <li>• The motor can be turned 90° when mounting, depending on the requirement. This means the connection side can be freely selected</li> </ul>	18

## Type codes

001	Series
ERMB	Rotary module

002	Size
20	20
25	25
32	32

Data sheet

Size  
20, 25, 32

 www.festo.com

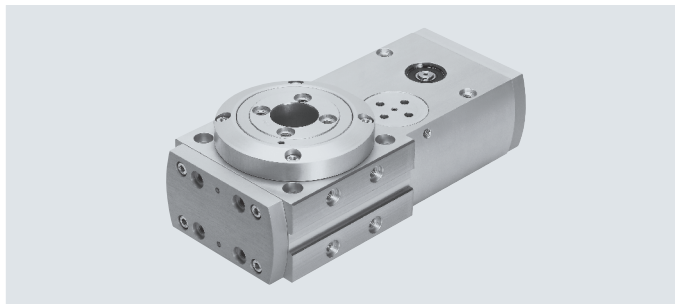

General technical data			
Size	20	25	32
Design	Electromechanical rotary module with toothed belt		
Drive pinion diameter [mm]	6	8	12
Rotation angle	Infinite		
Repetition accuracy <sup>1)</sup>			
with servo motor EMMT-AS, EMMS-AS [°]	±0.03		
with stepper motor EMMS-ST <sup>2)</sup> [°]	±0.08		
with integrated drive EMCA [°]	±0.05		
Positioning times	→ Page 9		
Transmission ratio	4.5:1	4:1	3:1
Position sensing	Via proximity switch		
Mounting position	Any		
Product weight [g]	850	1460	3250

- 1) As per FN 942 027. The specifications apply only when the motor is directly mounted. If a gear unit is also installed, the repetition accuracy will be different  
 2) Dependent on the encoder resolution

Mechanical data			
Size	20	25	32
Max. driving torque [Nm]	0.7	2.2	8.5
Max. output torque <sup>1)</sup> [Nm]	3.15	8.8	25.5
Average no-load driving torque <sup>2)</sup> [Nm]	<0.07	<0.18	≤ 0.5
Max. input speed [rpm]	1350	1200	900
Max. output speed [rpm]	300	300	300
Toothed belt pitch	2	3	5
Hollow shaft diameter [mm]	20	24	28

- 1) Output torque minus friction is dependent on rotational speed  
 2) At maximum rotational speed

Operating and environmental conditions			
Size	20	25	32
Ambient temperature [°C]	-10 ... +60		
Degree of protection	IP20		
Corrosion resistance CRC <sup>1)</sup>	2		
Sound pressure level <sup>2)</sup> [dB (A)]	32	49	53

- 1) Corrosion resistance class CRC 2 to Festo standard FN 940070  
 Moderate corrosion stress. Indoor applications in which condensation can occur. External visible parts with primarily decorative surface requirements which are in direct contact with a normal industrial environment.  
 2) In combination with servo motor EMMS-AS

## Data sheet

Mechanical data				
Size		20	25	32
Max. mass moment of inertia <sup>1)</sup>	[kgcm <sup>2</sup> ]	1000	5000	10000
Max. inertia factor <sup>2)</sup>				
for servo motor EMMT-AS/EMME-AS		45		
for stepper motor EMMS-ST		30		
for integrated drive EMCA		16		

1) These values specify the upper limit independently of what is determined using the inertia factor.

2) The inertia factor represents the maximum controllable ratio between the inertia of the load and the intrinsic inertia of the motor with brake.

Example:

Rotary lifting module ERMB-20 → transmission ratio  $i = 4.5$

Motor EMME-AS-40-S with brake → intrinsic inertia  $0.055 \text{ kgcm}^2$

Gear unit EMGA-40-P-G3-40 → transmission ratio  $i = 3$

Limit for inertia of the load (+ intrinsic inertia) on the output side:

$$0.055 \text{ kgcm}^2 \times 45 \times 3^2 \times 4.5^2 = 451 \text{ kgcm}^2$$

## Materials

## Sectional view

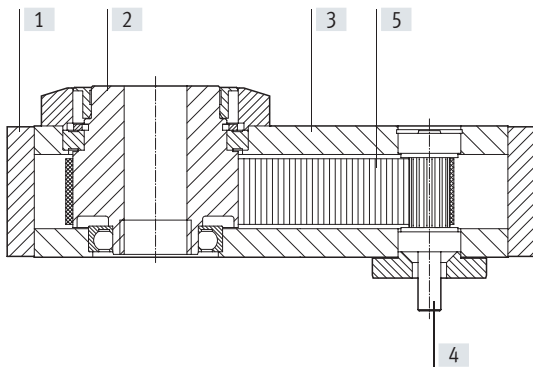

Rotary module	
[1] Cover	Anodised aluminium
[2] Output shaft	Anodised wrought aluminium alloy
[3] Housing	Anodised wrought aluminium alloy
[4] Drive shaft	High-alloy stainless steel
[5] Toothed belt	Polychloroprene with glass fibre
Note on materials	Contains paint-wetting impairment substances

## Data sheet

### Maximum radial and axial force Fx/Fy on the output shaft as a function of the distance y/z

If the rotary module is simultaneously subjected to several forces, the following equation must be satisfied in addition to the maximum loads indicated below.

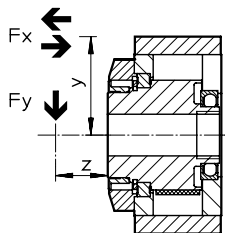

$$\frac{F_{y(z)}}{F_{y \max. (z)}} + \frac{F_{1x(v)}}{F_{1x \max. (v)}} + \frac{F_{2x(v)}}{F_{2x \max. (v)}} \leq 1$$

F1x = pushing

F2x = pulling

Max. radial force Fy, static

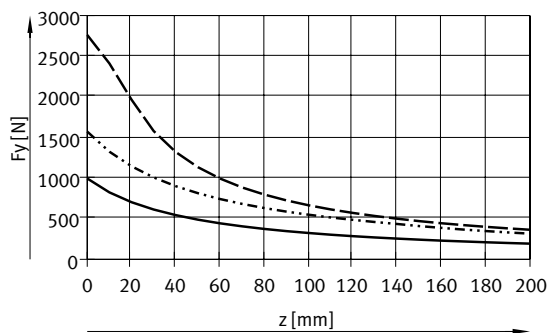

Max. radial force Fy, dynamic

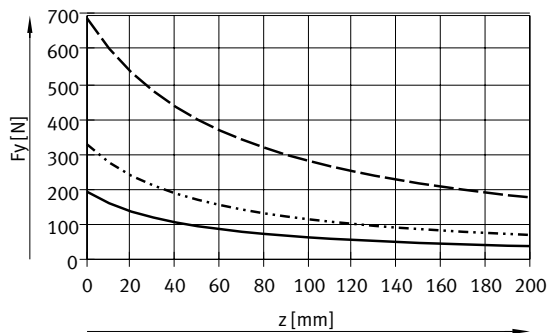

Max. axial force Fx, static, pushing and pulling

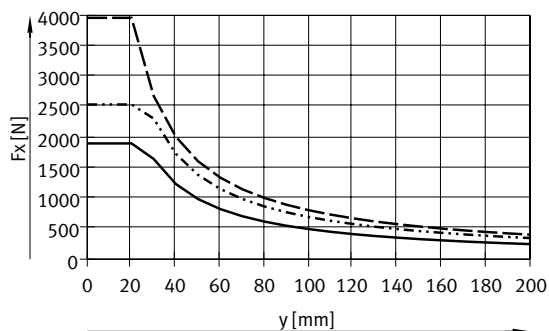

Max. axial force Fx, dynamic, pushing and pulling

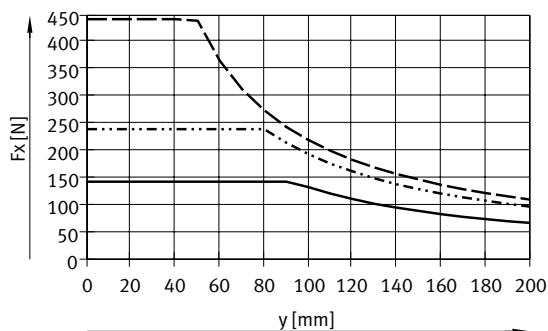

- ERMB-20
- ERMB-25
- - - ERMB-32







## Data sheet

Positioning time  $t$  as a function of the rotation angle  $\alpha$ 

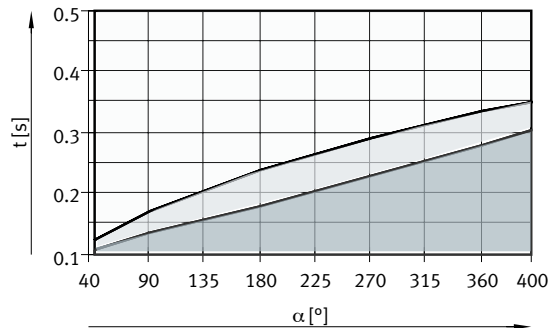
Size 20



With servo motor EMMS-AS

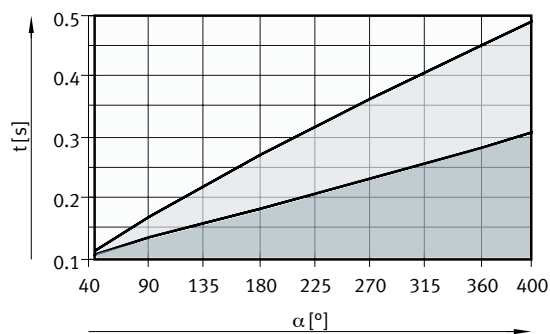

-  Extended operating range
-  Typical operating range, depending on the size of the motor and the inertia of the load
-  Non-viable range

With stepper motor EMMS-ST



-  Extended operating range
-  Typical operating range, depending on the size of the motor and the inertia of the load
-  Non-viable range

 **Note**

The positioning time  $t$  ends with the controller signal MC (motion complete), i.e. on the drive side.

Increased positioning times are to be expected at the output shaft depending on the motor type and eccentricity of the moving load.

For servo motor: 50 ... 100 ms

For stepper motor: 100 ... 200 ms

The engineering software "Electric Motion Sizing" compiles the optimum combination of rotary module and motor according to the application with regard to mass moment of inertia, positioning time, and positioning accuracy

→ [www.festo.com/x/electric-motion-sizing](http://www.festo.com/x/electric-motion-sizing)

## Data sheet

### Positioning time $t$ as a function of the rotation angle $\alpha$

Size 25

With servo motor EMMS-AS

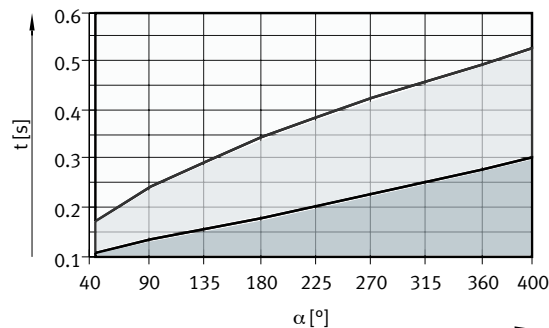

- Extended operating range
- Typical operating range, depending on the size of the motor and the inertia of the load
- Non-viable range

With stepper motor EMMS-ST

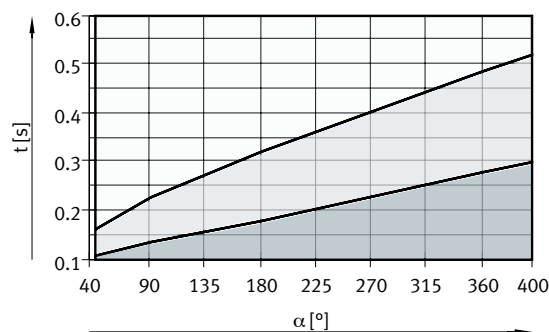

- Extended operating range
- Typical operating range, depending on the size of the motor and the inertia of the load
- Non-viable range

#### Note

The positioning time  $t$  ends with the controller signal MC (motion complete), i.e. on the drive side.

Increased positioning times are to be expected at the output shaft depending on the motor type and eccentricity of the moving load.

For servo motor: 50 ... 100 ms

For stepper motor: 100 ... 200 ms

The engineering software "Electric Motion Sizing" compiles the optimum combination of rotary module and motor according to the application with regard to mass moment of inertia, positioning time, and positioning accuracy

→ [www.festo.com/x/electric-motion-sizing](http://www.festo.com/x/electric-motion-sizing)



## Data sheet

Positioning time  $t$  as a function of the rotation angle  $\alpha$ 

Size 32

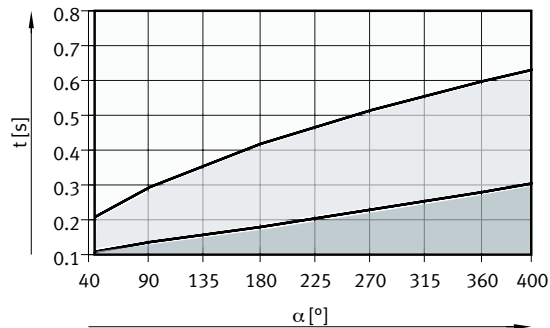

With servo motor EMMS-AS

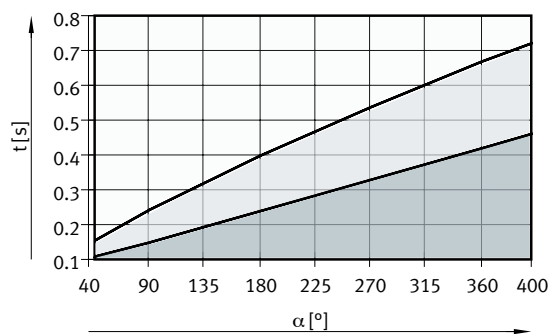

-  Extended operating range
-  Typical operating range, depending on the size of the motor and the inertia of the load
-  Non-viable range

With stepper motor EMMS-ST



-  Extended operating range
-  Typical operating range, depending on the size of the motor and the inertia of the load
-  Non-viable range

**Note**

The positioning time  $t$  ends with the controller signal MC (motion complete), i.e. on the drive side.

Increased positioning times are to be expected at the output shaft depending on the motor type and eccentricity of the moving load.

For servo motor: 50 ... 100 ms

For stepper motor: 100 ... 200 ms

The engineering software "Electric Motion Sizing" compiles the optimum combination of rotary module and motor according to the application with regard to mass moment of inertia, positioning time, and positioning accuracy

→ [www.festo.com/x/electric-motion-sizing](http://www.festo.com/x/electric-motion-sizing)

## Data sheet

**Information on service life values**

Within the scope of the product qualification, the specified static stress cycles/switching cycles were reached using 3 test objects.

**Definition of stress cycle/switching cycle:**

One switching cycle corresponds to two stress cycles: Position A to Position B and back.

Size		20	25	32
Stress cycle reference value	[million]	30	40	40
Switching cycle reference value	[million]	15	20	20
Mass moment of inertia on output	[kgcm <sup>2</sup> ]	24	80	400
Average angular acceleration on output	[°/sec <sup>2</sup> ]	28000	20000	12000
Maximum angular velocity on output	[°/sec]	1800	1800	1800

The static stress cycles/switching cycles specified above were achieved under the following, defined operating conditions: horizontal, hanging installation, 180° swivel angle, frequency 2 Hz, mass moment of inertia, acceleration (vibration-free) and max. angular velocity according to the table, room temperature (23 ±5) °C. Under deviating operating conditions, a shorter or longer service life may be achieved.

In addition, the working conditions and safety regulations specified in the product documentation must be observed.

Data sheet

Dimensions

Download CAD data → [www.festo.com](http://www.festo.com)

Size 20

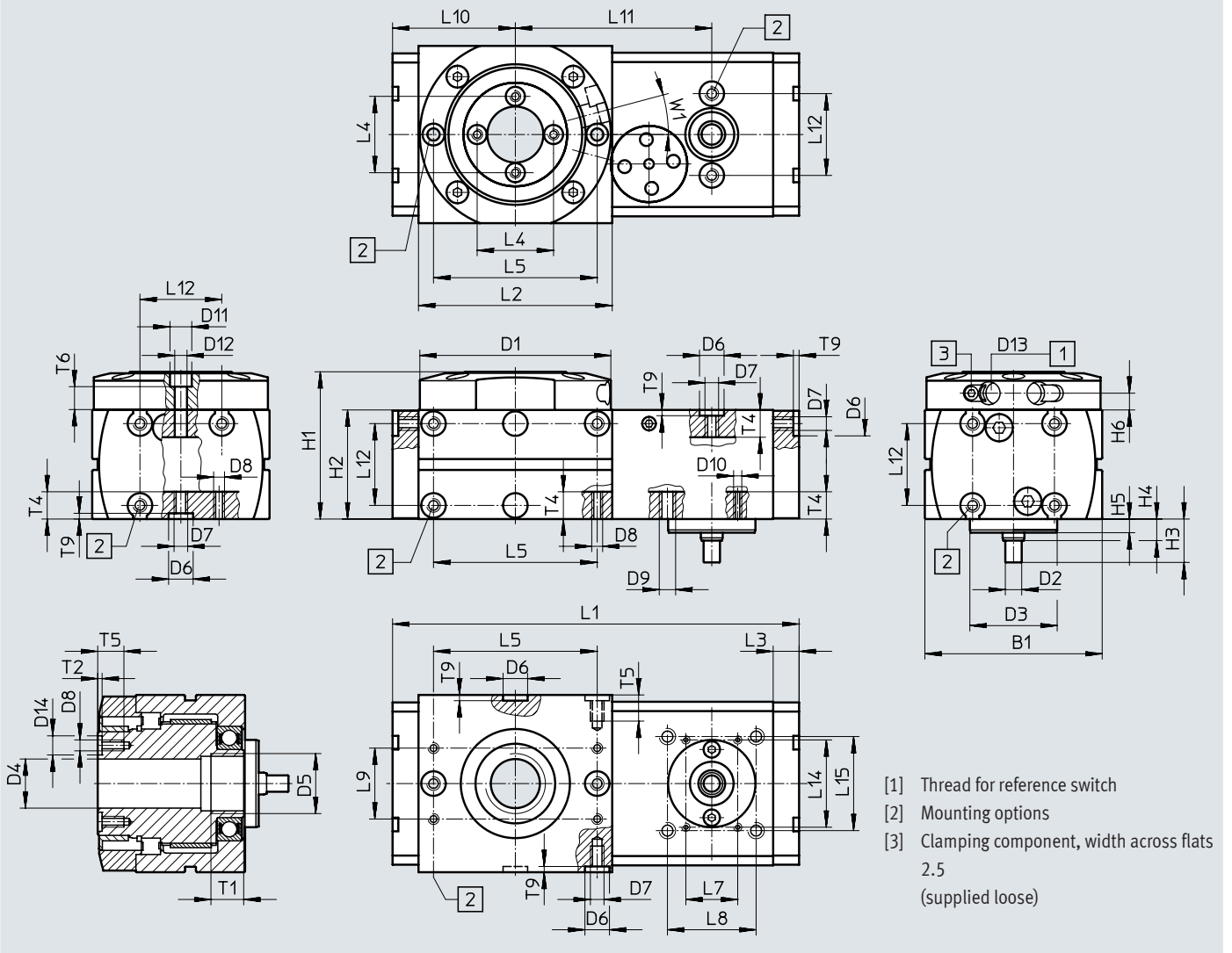

- [1] Thread for reference switch
- [2] Mounting options
- [3] Clamping component, width across flats 2.5 (supplied loose)

Size	B1	D1	D2	D3	D4	D5	D6	D7	D8	D9	D10	D11	D12	D13
	±0.2	∅ f9	∅ h6	∅ g7	∅ H7		∅ H7					∅	∅	
20	65	70	6	32	20	M22x1	9	M5	M4	M6	M3	8	4.5	M8x1

Size	D14	H1	H2	H3	H4	H5	H6	L1	L2	L3	L4 <sup>1)</sup>	L5 <sup>1)</sup>	L7	L8
	∅ H7	±0.5	±0.1					±0.5	±0.2	±0.1			±0.15	±0.15
20	7	54	40	15.9	7.9	5	6.15	149	71	9.5	28	60	19	32.5

Size	L9 <sup>1)</sup>	L10	L11	L12 <sup>1)</sup>	L14	L15	T1	T2	T4	T5	T6	T9	W1
			±0.05		±0.15	±0.15		+0.1		min		+0.2	
20	26	45	72	30	32	32.5	12	1.6	10	9.6	8.4	2.1	15°

1) Tolerance for centring hole ±0.02 mm  
Tolerance for thread ±0.1 mm

Data sheet

Dimensions

Download CAD data → [www.festo.com](http://www.festo.com)

Size 25/32

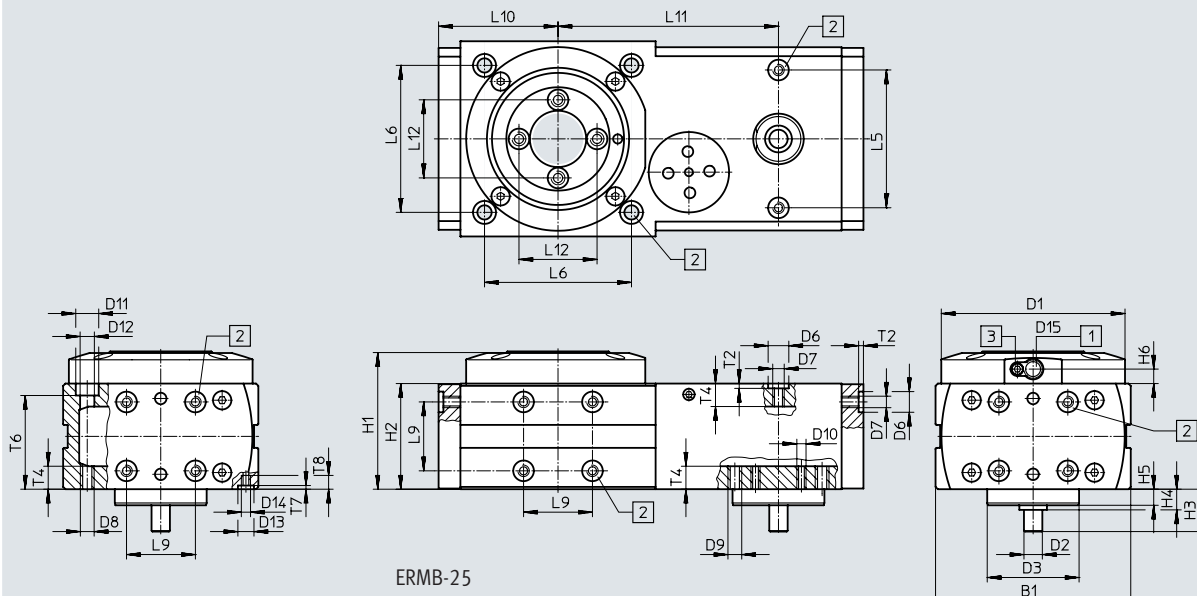

ERMB-25

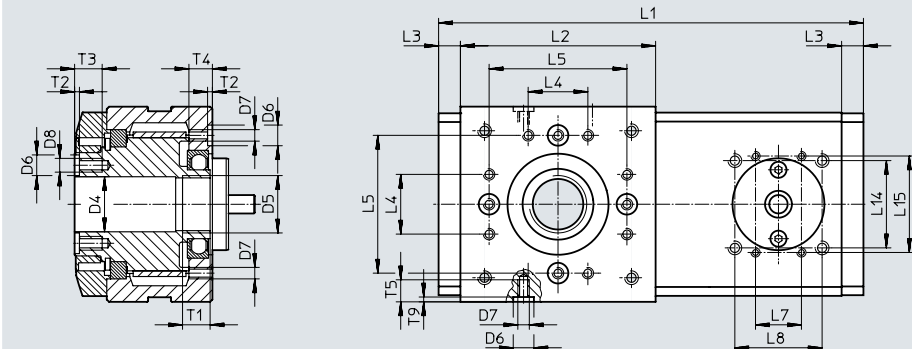

ERMB-32

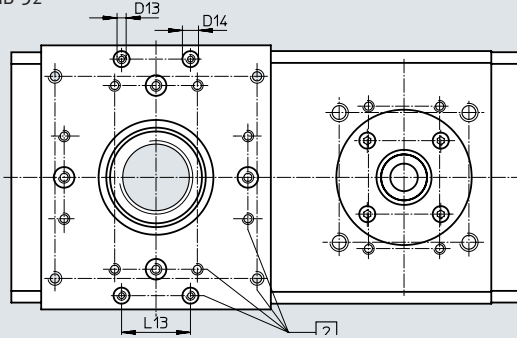

- 1] Thread for reference switch
- 2] Mounting options
- 3] Clamping component, width across flats 2.5 (supplied loose)

## Data sheet

Size	B1 ±0.2	D1 ∅ f9	D2 ∅ h6	D3 ∅ g7	D4 ∅ H7	D5	D6 ∅ H7	D7	D8	D9	D10
25	85	80	8	40	24	M25x1	9	M5	M6	M6	M4
32	115	112	12	60	28	M32x1.5	9	M5	M6	M8	M5

Size	D11 ∅	D12 ∅	D13 ∅ H7	D14	H1 ±0.5	H2 ±0.1	H3	H4	H5	H6	L1 ±0.5
25	10	6.2	–	–	60	46	18.45	–	7	6.45	185
32	10	6.2	7	M4	76.05	60	23.5	6.5	6	9.4	222

Size	L2 ±0.2	L3 ±0.1	L4 ±0.1	L5 <sup>1)</sup> ±0.1	L6	L7 ±0.15	L8 ±0.15	L9 <sup>1)</sup> ±0.1	L10	L11 ±0.05	L12 <sup>1)</sup> ±0.1	L13 <sup>1)</sup> ±0.1
25	85	9.5	26	60	64 ±0.15	20	38	30	52	96	34	–
32	100	13	36	80	88 ±0.1	31	56.5	40	63	108	45	30

Size	L14 ±0.15	L15 ±0.15	L16 +0.2	T1	T2 +0.1	T3 min	T4	T5 min	T6	T7 +0.1	T8 min	T9 +0.2
25	38	42	–	12	2.1	12	10	9.6	40.8±0.2	–	–	2.1
32	56.5	62	103	12	2.1	12	10	10	54.3	1.6	7.6	2.1

1) Tolerance for centring hole ±0.02 mm  
Tolerance for thread ±0.1 mm

Data sheet

Dimensions

Download CAD data → [www.festo.com](http://www.festo.com)

Sensing kit EAPS-R1-20-S for size 20

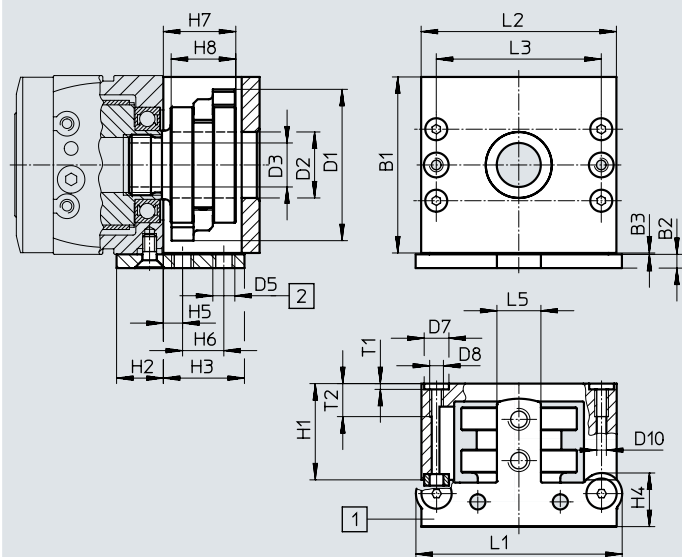

- \* Tolerance between the centring holes  $\pm 0.02$  mm
- [1] Sensor bracket for proximity switches SIEN-M8B
- [2] Thread for proximity switch SIEN-M8B

Sensing kit EAPS-R1-25-S for size 25

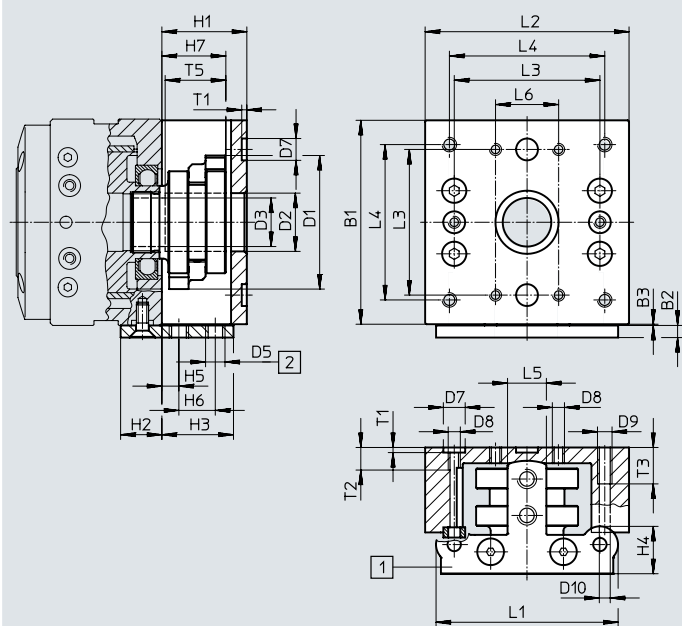

- \* Tolerance between the centring holes  $\pm 0.02$  mm
- [1] Sensor bracket for proximity switches SIEN-M8B
- [2] Thread for proximity switch SIEN-M8B



## Data sheet

## Dimensions

Download CAD data → [www.festo.com](http://www.festo.com)

Sensing kit EAPS-R1-32-S for size 32

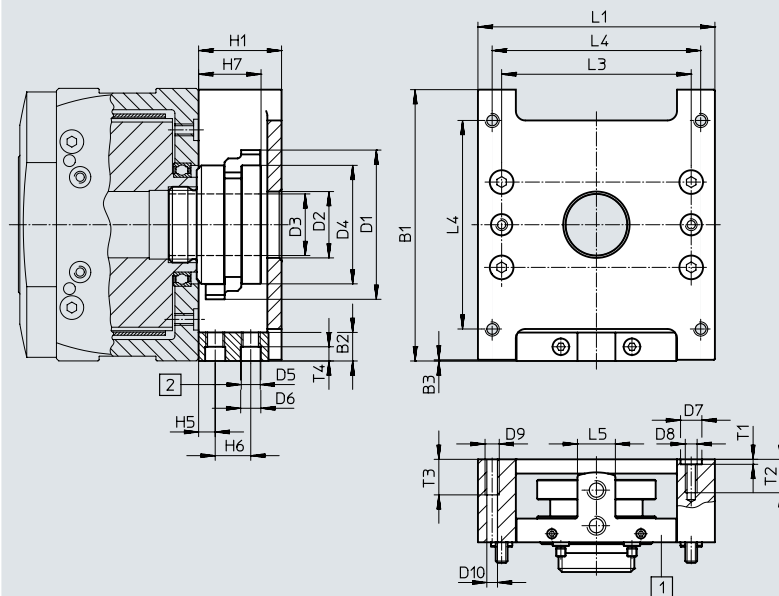

\* Tolerance between the centring holes  $\pm 0.02$  mm

[1] Sensor bracket for proximity switches SIEN-M8B

[2] Thread for proximity switch SIEN-M8B

Size	B1	B2	B3	D1 ∅	D2 ∅	D3 ∅	D4 ∅	D5	D6 ∅	D7 ∅ H7
20	64	5	0.5	55	24	16	–	M8x1	–	9
25	84	5	0.5	55	24	20	–	M8x1	–	9
32	114.5	12	0.5	63	28	26	50	M8x1	8.5	9

Size	D8	D9	D10 ∅	H1	H2	H3	H4	H5	H6	H7
20	M5	–	4.2	35	17	29.5	19.5	7	15	26.35
25	M5	M6	5.2	35	17	29.5	19.5	7	15	26.35
32	M5	M6	5.2	35	–	–	–	7	15	26.35

Size	H8	L1	L2	L3 <sup>1)</sup>	L4 $\pm 0.1$	L5 $\pm 0.1$	T1 $\pm 0.1$	T2	T3	T4	T5
20	23.5	75	71	60	–	16	2.1	12	–	–	–
25	–	75	84	60	–	16	2.1	9.3	15	–	25
32	–	100	–	80	88	16	2.1	14.1	15	6	–

1) Tolerance for centring hole  $\pm 0.02$  mm  
Tolerance for thread  $\pm 0.1$  mm

## Data sheet and accessories

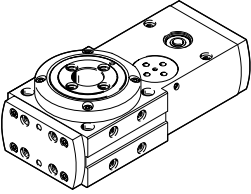
Ordering data	Size	Part no.	Type
	20	552706	ERMB-20
	25	552707	ERMB-25
	32	552708	ERMB-32

### Accessories

 **Note**

Depending on the combination of motor and drive, it may not be possible to reach the maximum feed force of the drive

#### Permissible axis/motor combinations with axial kit – Without gear unit

Data sheets → Internet: eamm-a

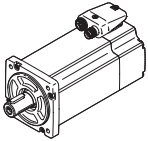
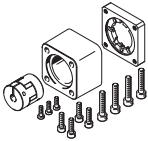
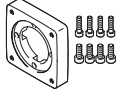
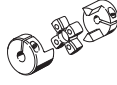
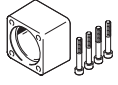
Motor <sup>1)</sup>	Axial kit	Axial kit comprises:		
Type	Part no. Type	Motor flange Part no. Type	Coupling Part no. Type	Coupling housing Part no. Type
				
<b>ERMB-20</b>				
<b>With servo motor</b>				
EMME-AS-40-...	2207441 EAMM-A-D32-35A-40P	–	533708 EAMC-30-32-6-8	2207509 EAMK-A-D32-35A-40P
EMMT-AS-60-..., EMME-AS-60-...	1956054 EAMM-A-D32-60P	1956846 EAMF-A-44C-60P	1233256 EAMC-30-32-6-14	551006 EAMK-A-D32-44A/C
<b>With stepper motor</b>				
EMMS-ST-42-...	543148 EAMM-A-D32-42A	552164 EAMF-A-28B-42A	543419 EAMC-16-20-5-6	552155 EAMK-A-D32-28B
EMMS-ST-57-...	550980 EAMM-A-D32-57A	530081 EAMF-A-44A/B-57A	551002 EAMC-30-32-6-6.35	551006 EAMK-A-D32-44A/C
<b>With integrated drive</b>				
EMCA-EC-67-...	1454239 EAMM-A-D32-67A	1476305 EAMF-A-44A/B/C-67A-S1	551003 EAMC-30-32-6-9	551006 EAMK-A-D32-44A/C

1) The input torque must not exceed the maximum permissible transferable torque of the axial kit.

## Accessories

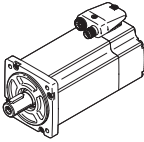
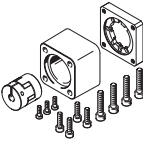
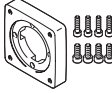
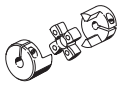
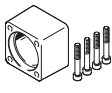
Permissible axis/motor combinations with axial kit – Without gear unit					Data sheets → Internet: eamm-a
Motor <sup>1)</sup>	Axial kit	Axial kit comprises:			
Type	Part no. Type	Part no. Type	Part no. Type	Part no. Type	
					
<b>ERMB-25</b>					
<b>With servo motor</b>					
EMMT-AS-60-..., EMME-AS-60-...	1977000 EAMM-A-D40-60P	1956846 EAMF-A-44C-60P	562682 EAMC-30-32-8-14	552157 EAMK-A-D40-44A/C	
<b>With stepper motor</b>					
EMMS-ST-57-...	543154 EAMM-A-D40-57A	530081 EAMF-A-44A/B-57A	543421 EAMC-30-32-6.35-8	552157 EAMK-A-D40-44A/C	
EMMS-ST-87-...	550982 EAMM-A-D40-87A	530082 EAMF-A-44A/B-87A	551004 EAMC-30-32-8-11	552157 EAMK-A-D40-44A/C	
<b>With integrated drive</b>					
EMCA-EC-67-...	1454243 EAMM-A-D40-67A	1476305 EAMF-A-44A/B/C-67A-S1	543423 EAMC-30-32-8-9	552157 EAMK-A-D40-44A/C	
<b>ERMB-32</b>					
<b>With servo motor</b>					
EMMT-AS-80-..., EMME-AS-80-...	1977073 EAMM-A-D60-80P	1977113 EAMF-A-64A/C-80P	551005 EAMC-42-50-12-19	551007 EAMK-A-D60-64C	
EMMT-AS-100-..., EMME-AS-100-...	550983 EAMM-A-D60-100A	529947 EAMF-A-64A/C/D-100A	551005 EAMC-42-50-12-19	551007 EAMK-A-D60-64C	
<b>With stepper motor</b>					
EMMS-ST-87-...	543162 EAMM-A-D60-87A	533140 EAMF-A-64A/B-87A	543424 EAMC-42-50-11-12	552160 EAMK-A-D60-64B	

1) The input torque must not exceed the maximum permissible transferable torque of the axial kit.

Accessories

Data sheets → Internet: eamm-a

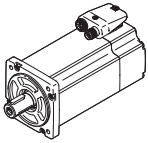
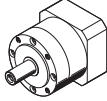
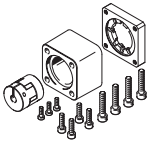
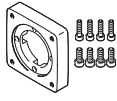
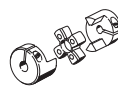
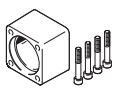
Permissible axis/motor combinations with axial kit – With gear unit					
Motor <sup>1)</sup>	Gear unit	Axial kit	Axial kit comprises:		
Type	Type	Part no. Type	Motor flange Part no. Type	Coupling Part no. Type	Coupling housing Part no. Type
					
<b>ERMB-20</b>					
<b>With servo motor</b>					
EMME-AS-40-...	EMGA-40-P-G...-EAS-40	1454238 EAMM-A-D32-40G	1460095 EAMF-A-44C-40G-S1	562681 EAMC-30-32-6-10	551006 EAMK-A-D32-44A/C
EMMT-AS-60-..., EMME-AS-60-...	EMGA-60-P-G...-EAS-60	2946760 EAMM-A-D32-60H	1460105 EAMF-A-44C-60G/H-S1	1233256 EAMC-30-32-6-14	551006 EAMK-A-D32-44A/C
<b>With stepper motor</b>					
EMMS-ST-42-...	EMGA-40-P-G...-SST-42	1454238 EAMM-A-D32-40G	1460095 EAMF-A-44C-40G-S1	562681 EAMC-30-32-6-10	551006 EAMK-A-D32-44A/C
EMMS-ST-57-...	EMGA-60-P-G...-SST-57	2946758 EAMM-A-D32-60G	1460105 EAMF-A-44C-60G/H-S1	3187577 EAMC-30-32-6-11	551006 EAMK-A-D32-44A/C
<b>With integrated drive</b>					
EMCA-EC-67-...	EMGC-40-...	1454238 EAMM-A-D32-40G	1460095 EAMF-A-44C-40G-S1	562681 EAMC-30-32-6-10	551006 EAMK-A-D32-44A/C
	EMGC-60-...	2946760 EAMM-A-D32-60H	1460105 EAMF-A-44C-60G/H-S1	1233256 EAMC-30-32-6-14	551006 EAMK-A-D32-44A/C

1) The input torque must not exceed the maximum permissible transferable torque of the axial kit.

## Accessories

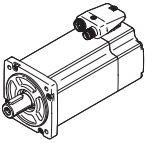
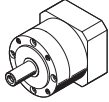
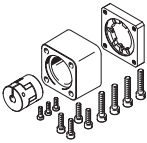
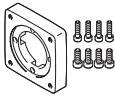
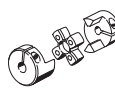
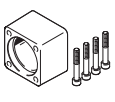
Permissible axis/motor combinations with axial kit – With gear unit						Data sheets → Internet: eamm-a
Motor <sup>1)</sup>	Gear unit	Axial kit	Axial kit comprises:			
Type	Type	Part no. Type	Motor flange Part no. Type	Coupling Part no. Type	Coupling housing Part no. Type	
						
<b>ERMB-25</b>						
<b>With servo motor</b>						
EMME-AS-40-...	EMGA-40-P-G...-EAS-40	560282 EAMM-A-D40-40G	550986 EAMF-A-44A/B-40G	558029 EAMC-30-32-8-10	552157 EAMK-A-D40-44A/C	
		2256398 EAMM-A-D40-40G-G2 <sup>2)</sup>	1460095 EAMF-A-44C-40G-S1	558029 EAMC-30-32-8-10	552157 EAMK-A-D40-44A/C	
EMMT-AS-60-..., EMME-AS-60-...	EMGA-60-P-G...-EAS-60	1454242 EAMM-A-D40-60H	1460105 EAMF-A-44C-60G/H-S1	562682 EAMC-30-32-8-14	552157 EAMK-A-D40-44A/C	
<b>With stepper motor</b>						
EMMS-ST-42-...	EMGA-40-P-G...-SST-42	560282 EAMM-A-D40-40G	550986 EAMF-A-44A/B-40G	558029 EAMC-30-32-8-10	552157 EAMK-A-D40-44A/C	
EMMS-ST-57-...	EMGA-60-P-G...-SST-57	2256400 EAMM-A-D40-60G	1460105 EAMF-A-44C-60G/H-S1	551004 EAMC-30-32-8-11	552157 EAMK-A-D40-44A/C	
<b>With integrated drive</b>						
EMCA-EC-67-...	EMGC-40-...	560282 EAMM-A-D40-40G	550986 EAMF-A-44A/B-40G	558029 EAMC-30-32-8-10	552157 EAMK-A-D40-44A/C	
		2256398 EAMM-A-D40-40G-G2 <sup>2)</sup>	1460095 EAMF-A-44C-40G-S1	558029 EAMC-30-32-8-10	552157 EAMK-A-D40-44A/C	
	EMGC-60-...	1454242 EAMM-A-D40-60H	1460105 EAMF-A-44C-60G/H-S1	562682 EAMC-30-32-8-14	552157 EAMK-A-D40-44A/C	

1) The input torque must not exceed the maximum permissible transferable torque of the axial kit.

2) The axial kit can be retrofitted from IP40 to IP65 with the help of a seal set EADS-F. Additional information → eamm-a

Accessories

Data sheets → Internet: eamm-a

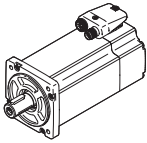
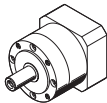
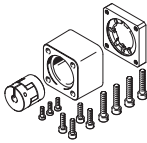
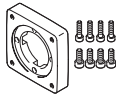
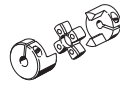
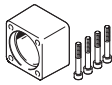
Permissible axis/motor combinations with axial kit – With gear unit					
Motor <sup>1)</sup>	Gear unit	Axial kit	Axial kit comprises:		
Type	Type	Part no. Type	Motor flange Part no. Type	Coupling Part no. Type	Coupling housing Part no. Type
					
<b>ERMB-32</b>					
<b>With servo motor</b>					
EMMT-AS-60-..., EMME-AS-60-...	EMGA-60-P-G...-EAS-60	1454245 EAMM-A-D60-60H	2256289 EAMF-A-64B-60G/H-S1	1455671 EAMC-42-50-12-14	552160 EAMK-A-D60-64B
EMMT-AS-80-..., EMME-AS-80-...	EMGA-80-P-G...-EAS-80	1499402 EAMM-A-D60-80G	2843290 EAMF-A-64C-80G-S1	2138701 EAMC-42-50-12-20	551007 EAMK-A-D60-64C
EMMT-AS-100-..., EMME-AS-100-...	EMGA-80-P-G...-SAS-100	1499402 EAMM-A-D60-80G	2843290 EAMF-A-64C-80G-S1	2138701 EAMC-42-50-12-20	551007 EAMK-A-D60-64C
<b>With stepper motor</b>					
EMMS-ST-57-...	EMGA-60-P-G...-SST-57	560283 EAMM-A-D60-60G	550987 EAMF-A-64A/B-60G	543424 EAMC-42-50-11-12	552160 EAMK-A-D60-64B
		2256696 EAMM-A-D60-60G-G2 <sup>2)</sup>	2256289 EAMF-A-64B-60G/H-S1	543424 EAMC-42-50-11-12	552160 EAMK-A-D60-64B
EMMS-ST-87-...	EMGA-80-P-G...-SST-87	1499402 EAMM-A-D60-80G	2843290 EAMF-A-64C-80G-S1	2138701 EAMC-42-50-12-20	551007 EAMK-A-D60-64C
<b>With integrated drive</b>					
EMCA-EC-67-...	EMGC-60-...	1454245 EAMM-A-D60-60H	2256289 EAMF-A-64B-60G/H-S1	1455671 EAMC-42-50-12-14	552160 EAMK-A-D60-64B

1) The input torque must not exceed the maximum permissible transferable torque of the axial kit.  
 2) The axial kit can be retrofitted from IP40 to IP65 with the help of a seal set EADS-F. Additional information → eamm-a

 - **Note**  
 Note the maximum permissible driving torque of the ERMB.  
 The motor current may need to be limited.

## Accessories

Ordering data – Centring sleeves						
	For size	Brief description	Number	Part no.	Type	PU <sup>1)</sup>
	20	For centring loads and attachments (centring sleeves are included in the scope of delivery of the rotary module)	2	8146544	ZBH-7-B	10
			2	8137184	ZBH-9-B	
	25, 32		4			

1) Packaging unit

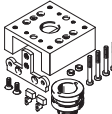
Ordering data						
	For size	Brief description	Weight [g]	Part no.	Type	PU <sup>1)</sup>
<b>Sensing kit EAPS-...-S</b>						
	20	Kit with housing (trip cam support, 2 cams, sensor bracket)	258	558392	EAPS-R1-20-S	1
	25		406	558393	EAPS-R1-25-S	
	32		560	558394	EAPS-R1-32-S	

<b>Sensing kit without housing EAPS-...-S-WH</b>						
	20	Kit without housing (trip cam support, 2 cams, sensor bracket)	86	558395	EAPS-R1-20-S-WH	1
	25		90	558396	EAPS-R1-25-S-WH	
	32		136	558397	EAPS-R1-32-S-WH	

<b>Cam EAPS-...-CK</b>						
	20, 25, 32	For sensing positions (2 cams included in the scope of delivery)	5 each	558398	EAPS-R1-CK	2

<b>Sensor bracket EAPS-...-SH</b>						
	20, 25	For mounting proximity switches on the rotary module	24	558399	EAPS-R1-20-SH	1
	32		30	558400	EAPS-R1-32-SH	

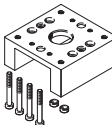
<b>Housing EAPS-...-H</b>						
	20	For protecting the sensing kit and as mounting interface for the drive	172	560673	EAPS-R1-20-H	1
	25		316	560674	EAPS-R1-25-H	
	32		424	560675	EAPS-R1-32-H	

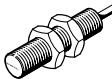
Ordering data – Proximity switches, inductive					Data sheets → Internet: sien
	Contact	Connection	Part no.	Type	
	N/O	Cable, 2.5 m	150386	SIEN-M8B-PS-K-L	
		Plug	150387	SIEN-M8B-PS-S-L	
	N/C	Cable, 2.5 m	150390	SIEN-M8B-PO-K-L	
		Plug	150391	SIEN-M8B-PO-S-L	

Ordering data – Connecting cables					Data sheets → Internet: nebu
	Electrical connection, left	Electrical connection, right	Cable length [m]	Part no.	Type
	Straight socket, M8x1, 3-pin	Cable, open end,	2.5	541333	NEBU-M8G3-K-2.5-LE3
		3-wire	5	541334	NEBU-M8G3-K-5-LE3

## Accessories

### Adapter kit HAPB

Material:  
Wrought aluminium alloy  
Free of copper and PTFE  
RoHS-compliant



#### Note

The kit includes the individual mounting interface as well as the necessary mounting material.

#### Permissible drive/drive combinations with adapter kit

Download CAD data → [www.festo.com](http://www.festo.com)

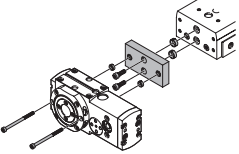
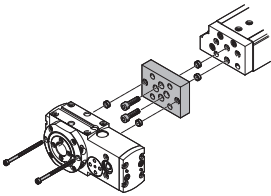
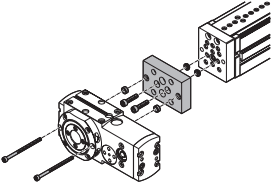
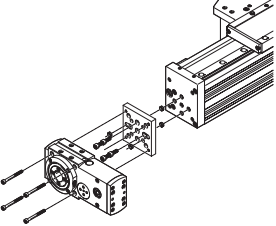
Combination	[1] Drive Size	[2] Drive Size	Adapter kit		
			CRC <sup>1)</sup>	Part no.	Type
	DGST	ERMB	DHAA		
	20	20	2	8162108	DHAA-D-G8-20-R1-20
	25	25		8162109	DHAA-D-G8-25-R1-25
	DGSL	ERMB	HAPB		
	16, 20, 25	20	2	558306	HAPB-38
	20, 25	25		558307	HAPB-39
	25	32		558308	HAPB-40
	EGSL	ERMB	HAPB		
	45, 55, 75	20	2	558306	HAPB-38
	75	25		558307	HAPB-39
	75	32		558308	HAPB-40
	ELCC	ERMB	HAPB		
	60, 70	20	2	558306	HAPB-38
	70, 90	25		558307	HAPB-39
	90, 110	32		558308	HAPB-40

1) Corrosion resistance class CRC 2 to Festo standard FN 940070

Moderate corrosion stress. Indoor applications in which condensation can occur. External visible parts with primarily decorative surface requirements which are in direct contact with a normal industrial environment.



# Festo - Your Partner in Automation



**1 Festo Inc.**  
5300 Explorer Drive  
Mississauga, ON L4W 5G4  
Canada

**Festo Customer Interaction Center**  
Tel: 1 877 463 3786  
Fax: 1 877 393 3786  
Email: [customer.service.ca@festo.com](mailto:customer.service.ca@festo.com)



**2 Festo Pneumatic**  
Av. Ceylán 3,  
Col. Tequesquináhuac  
54020 Tlalnepantla,  
Estado de México

**Multinational Contact Center**  
01 800 337 8669  
[ventas.mexico@festo.com](mailto:ventas.mexico@festo.com)



**3 Festo Corporation**  
1377 Motor Parkway  
Suite 310  
Islandia, NY 11749

**Festo Customer Interaction Center**  
1 800 993 3786  
1 800 963 3786  
[customer.service.us@festo.com](mailto:customer.service.us@festo.com)



**4 Regional Service Center**  
7777 Columbia Road  
Mason, OH 45040

Connect with us



[www.festo.com/socialmedia](http://www.festo.com/socialmedia)



[www.festo.com](http://www.festo.com)

Subject to change