

## Rotary drive units ERMS

**FESTO**



This product is also available as a modular mechanical system  
Rotary drive ERMO



## Key features

### At a glance

#### Plug and work with the Simplified Motion Series

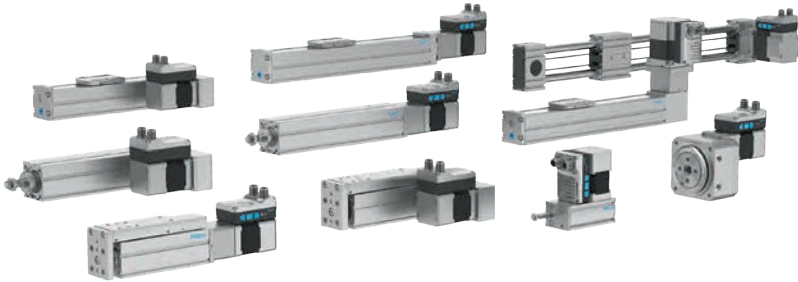

The simplicity of pneumatics is now combined for the first time with the advantages of electric automation thanks to the Simplified Motion Series. These integrated drives are the perfect solution for all users who are looking for an electric alternative for very simple movement and positioning tasks between two mechanical end positions, but don't want the commissioning process for traditional electric drive systems that can often be quite complex.



There is no need for any software since operation is simply based on the "plug and work" principle. Digital I/O (DIO) and IO-Link are always automatically included – a product with two types of control as standard.

#### Integrated

The integrated electronics in the drive are at the heart of the Simplified Motion Series.

#### Easy

For commissioning, simply set all relevant parameters directly on the drive:

- Speed and force
- Reference end position and cushioning
- Manual operation

#### Standardised

Electrical connection via M12 plug design

- Power (4-pin): power supply for the motor
- Logic (8-pin): control signal, sensor signal and power for the integrated electronics

#### Connected

Use of extended functions possible via IO-Link:

- Remote configuration of motion parameters
- Copy and backup function for transferring parameters
- Read function for extended process parameters
- Freely definable intermediate position
- Firmware update

### The functions of the Simplified Motion Series

Basic profile for movement between two end positions: with speed control

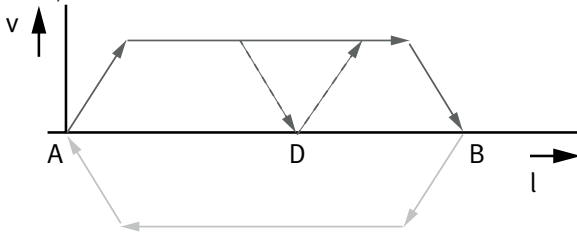

Extended motion profile for simplified press-fitting and clamping functions: with speed and force control

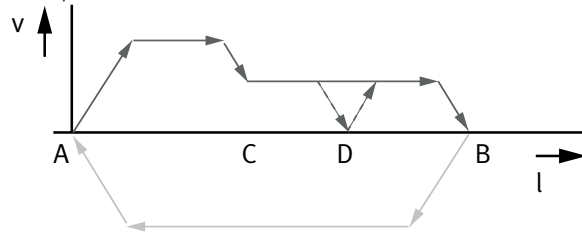

- These drives are designed for simple movements between two end positions.
- Proximity switches are required in order to implement any intermediate positions.
- With the intermediate position that can be freely configured via IO-Link, movements can be stopped at a freely defined point between the end positions, without the need for proximity switches or external stops

## Key features

## At a glance



- Without external servo drive: all the necessary electronic components are combined in the integrated drive
- Two control options integrated as standard: digital I/O and IO-Link
- Complete solution for simple movements between mechanical end positions
- Simplified commissioning: all parameters can be manually set directly on the drive
- No special expertise required for commissioning
- End-position feedback similar to that of a conventional proximity switch is integrated as standard
- Sealed hollow shaft for the integrated through-feed of cables and tubing
- Standardised mounting interface for direct connection to the electric mini slides EGSL, EGSC and EGSS

## The products in the Simplified Motion Series

Electric cylinder unit  
EPCE



Mini slide unit  
EGSS-BS-KF

Electric cylinder unit  
EPCS



Mini slide unit with parallel motor  
mounting  
EGSS-BS-KF

Electric cylinder unit with parallel  
motor mounting  
EPCS



Spindle axis unit  
ELGS-BS-KF

Spindle axis unit with parallel motor  
mounting  
ELGS-BS-KF



Toothed belt axis unit  
ELGS-TB-KF

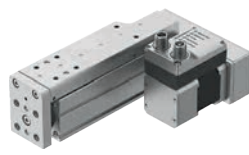

Toothed belt axis unit  
ELGE



Rotary drive unit  
ERMS

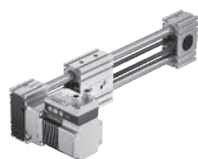
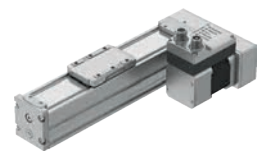

## Modular and flexible with motor, motor mounting kit and servo drive

This product is also available within the Optimised Motion Series as rotary drive ERMO:



Rotary drive and motor in one unit. Compact and powerful rotating and swivelling with no limits. Sturdy and precise thanks to backlash-free ball bearing.

- Rotary drive in 4 sizes for torque of up to 5 Nm
- Hollow shaft for energy through-feed for attachments
- Optional pneumatic or electric energy chain
- Optional proximity switch for homing or position sensing
- Holding brake optional
- Modular: individual combinations with servo drive

## Key features

### Possible combinations with Festo drives

#### Rotary drive unit ERMS on electric cylinder EPCO

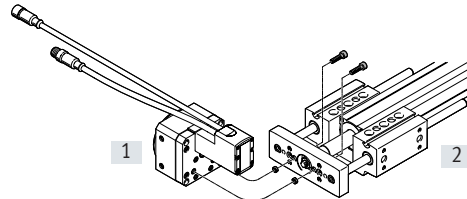
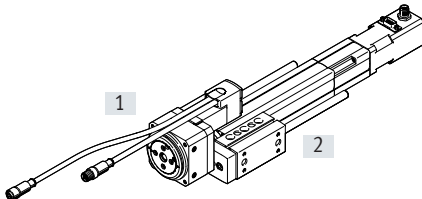

Size		Accessories	
[1] ERMS	[2] EPCO	Centring sleeve	Screw
25	40	ZBH-7 (x2)	M5x20 (x2)

#### Rotary drive unit ERMS on mini slide unit EGSS

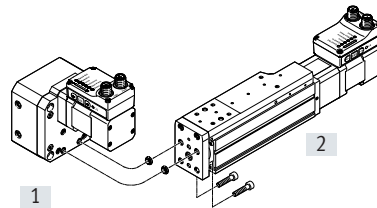
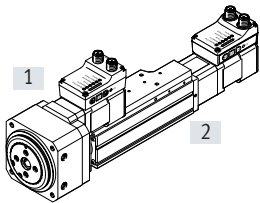

Size		Accessories	
[1] ERMS	[2] EGSS	Centring sleeve	Screw
25	45, 60	ZBH-7 (x2)	M5x12 (x2)
32	60	ZBH-7 (x2)	M5x15 (x2)

#### Rotary drive unit ERMS on mini slide EGSL

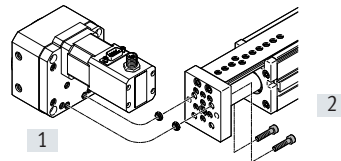
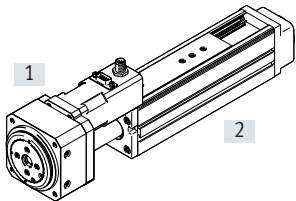

Size		Accessories	
[1] ERMS	[2] EGSL	Centring sleeve	Screw
25	55	ZBH-7 (x2)	M5x14 (x2)
32	55	ZBH-7 (x2)	M5x14 (x2)

#### Rotary drive unit ERMS on mini slide DGSL

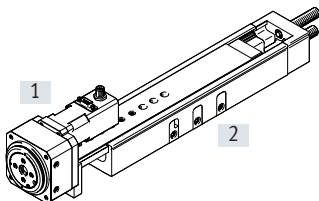

The proximity switch SIEN cannot be used as a reference sensor on the ERMO when ERMO-12 is combined with DGSL-12.

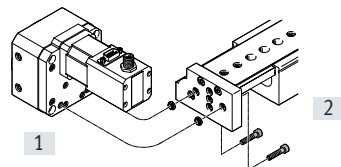

Size		Accessories	
[1] ERMS	[2] DGSL	Centring sleeve	Screw
25	20	ZBV-9-7 (x2)	M5x22 (x2)
25	25	ZBV-9-7 (x2)	M5x22 (x2)

## Type codes

001	Series		
ERMS	Rotary drive		
002	Size		
25	25		
32	32		
003	Nominal swivel angle		
90	90°		
180	180°		
004	Motor type		
ST	Stepper motor ST		
005	Controller		
M	Integrated		
006	Control panel		
H1	Integrated		
007	Bus protocol/activation		
PLK	PNP and IO-Link®		
NLK	NPN and IO-Link®		
008	End-position sensing		
AA	With integrated end-position sensing		
009	Cable outlet direction		
	Standard		
L	Left		
R	Right		
010	Electrical accessories		
	None		
L1	Adapter for operation as IO-Link® device		

Peripherals overview

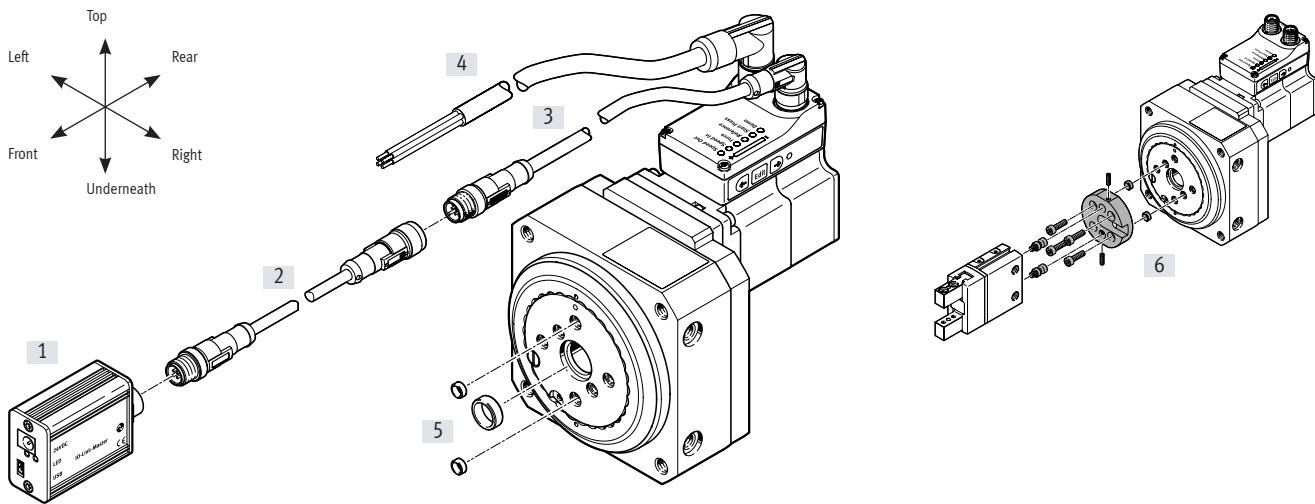

Cable outlet direction

Standard

[L] Left

[R] Right

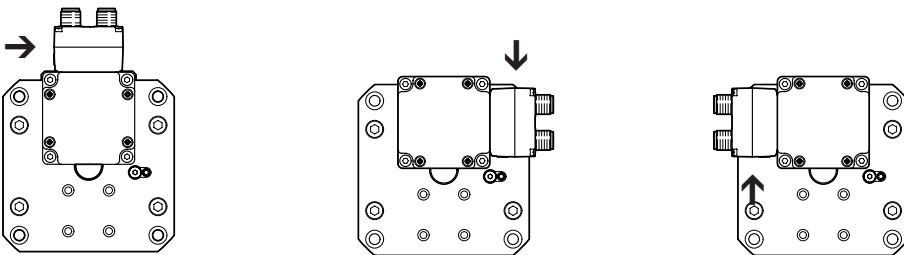

Control elements

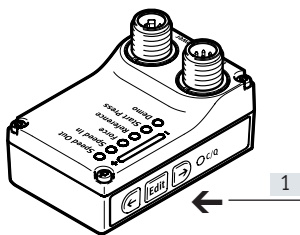



[1] Pushbutton actuators for parameterisation and control

## Peripherals overview

Accessories			
	Type/order code	Description	→ Page/Internet
[1]	IO-Link master USB CDSU-1	For straightforward use of the mini slide unit via IO-Link	21
[2]	Adapters NEFC-M12G8	Connection between the motor and the IO-Link master	21
[3]	Connecting cable NEBC-M12	For connection to a controller	20
[4]	Supply cable NEBL-T12	For connecting load and logic supply	20
[5]	Centring sleeve ZBH	<ul style="list-style-type: none"> <li>• For centring attachments</li> <li>• For centring the rotary drive</li> </ul>	20
[6]	Adapter kit DHAA	For drive/gripper connections	adapter kit

## Datasheet

-  Size  
25, 32
-  Rotation angle  
90°, 180°

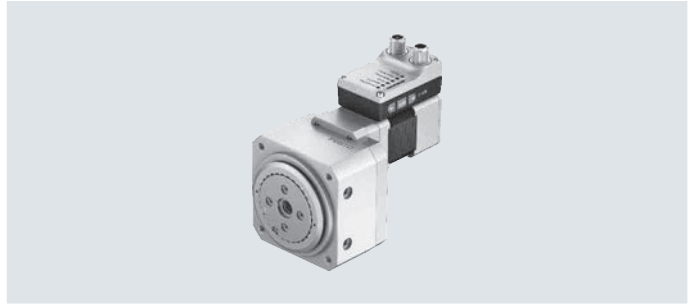

General technical data			
Size		25	32
Design		Electromechanical rotary drive with integrated drive	
Rotation angle		90, 180	
Gear ratio		9:1	7:1
Mounting position		Any	
Additional functions		Built-in end-position sensing User interface	
Display		LED	
Homing		Positive fixed stop block Negative fixed stop block	
Type of mounting		With female thread	
Max. cable length			
Inputs/outputs	[m]	15	
IO-Link operation	[m]	20	
Product weight		1472	2304

Mechanical data			
Size		25	32
Permissible mass moment of inertia	[kgcm <sup>2</sup> ]	65	164
Peak torque	[Nm]	2.7	5.6
Max. speed <sup>1)</sup>	[rpm]	150	100
Max. speed at 90°	[rpm]	105	100
Speed "Speed Press" <sup>2)</sup>	[rpm]	3	2
Angular acceleration <sup>2)</sup>	[rad/s <sup>2</sup> ]	≤140	
Repetition accuracy	[°]	±0.05	±0.1
Torsional backlash <sup>3)</sup>	[°]	0.2	0.2

1) Adjustable increments of 10%

2) Unchangeable parameter

3) Without load in new condition



## Datasheet

Electrical data			
Size		25	32
Motor			
Nominal voltage DC	[V]	24 (±15%)	
Nominal current	[A]	3	5.3
Max. current consumption (load)	[A]	3	5.3
Max. current consumption (logic)	[mA]	300	
Encoder			
Rotor position sensor		Absolute encoder, single turn	
Rotor position sensor measuring principle		Magnetic	
Rotor position encoder resolution	[bit]	16	
Interfaces			
Size		25	32
Parameterisation interface			
IO-Link		Yes	
User interface		Yes	
Digital inputs			
Number		2	
Switching logic		PNP	
		NPN	
Characteristics		Not galvanically isolated	
		Configurable	
Specification		Based on IEC 61131-2, type 1	
Operating range	[V]	24	
Digital outputs			
Number		2	
Switching logic		PNP	
		NPN	
Rotor position sensor		Absolute encoder, single turn	
Characteristics		Not galvanically isolated	
		Configurable	
Max. current	[mA]	100	

## Datasheet

Technical data – IO-Link		
Size	25	32
SIO mode support	Yes	
Communication mode	COM3 (230.4 kBd)	
Connection technology	Plug	
Port class	A	
No. of ports	1	
Process data width OUT	[byte]	2
Process data content OUT	[bit]	1 (Move in)
	[bit]	1 (Move out)
	[bit]	1 (Move Intermediate)
	[bit]	1 (Quit Error)
Process data width IN	[byte]	2
Process data content IN	[bit]	1 (State Device)
	[bit]	1 (State Move)
	[bit]	1 (State in)
	[bit]	1 (State out)
	[bit]	1 (State Intermediate)
Service data content IN	[bit]	32 (Force)
	[bit]	32 (Position)
	[bit]	32 (Speed)
Minimum cycle time	[ms]	1
Data memory required	[kilobyte]	0.5
Protocol version	Device V 1.1	

Operating and environmental conditions		
Size	25	32
Insulation class	B	
Ambient temperature	[°C]	0 ... +50
Storage temperature	[°C]	-20 ... +60
Note on ambient temperature	Above an ambient temperature of 30°C, the power must be reduced by 2% per K	
Temperature monitoring	Switch-off for excessive temperature	
	Integrated precise CMOS temperature sensor with analogue output	
Relative humidity	[%]	0 ... 85
Protection class	III	
Degree of protection	IP40	
Duty cycle	[%]	100
CE marking (see declaration of conformity)	To EU EMC Directive for EMCS-ST → festo.com/sp	
	To EU RoHS Directive	
UKCA marking (see declaration of conformity)	To UK instructions for EMC	
	To UK RoHS instructions	
KC mark	KC EMC	
Certification	RCM	
Vibration resistance	Transport application test with severity level 1 to FN 942017-4 and EN 61800-2 and EN 61800-5-1	
Shock resistance	Shock test with severity level 1 to FN 942017-5 and EN 61800-2	
Maintenance interval	Lifetime lubrication	

Datasheet

Materials

Sectional view

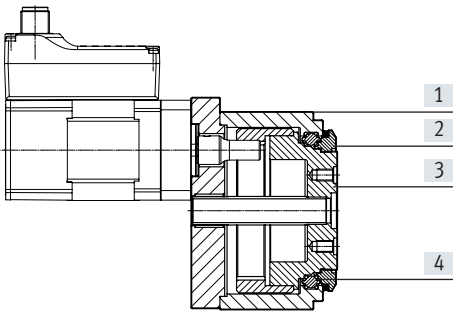

Rotary drive

[1]	Housing	Anodised wrought aluminium alloy
[2]	Clamping ring	Anodised wrought aluminium alloy
[3]	Rotating plate	Anodised wrought aluminium alloy
[4]	Ball bearings	Rolling bearing steel
	Sealing ring	NBR
	PWIS conformity	VDMA24364 zone III
	Note on materials	RoHS-compliant

Pin allocation

Power supply

Plug

M12x1, 4-pin, T-coded to EN 61076-2-111

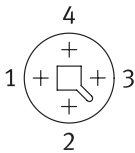

Pin	Function
1	Power voltage supply (24 V DC)
2	Reference potential, power voltage supply (GND)
3	Reserved, do not connect
4	Functional earth (FE)

Logic interface

Plug

M12x1, 8-pin, A-coded to EN 61076-2-101

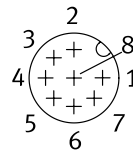

When used with digital I/O

Pin	Function
1	Logic voltage supply (24 V DC)
2	Digital output 1 (State "In")
3	Digital output 2 (State "Out")
4	Reference potential, logic voltage supply (GND)
5	Digital input 1 (Move "In")
6	Digital input 2 (Move "Out")
7	Reserved, do not connect
8	Reference potential, logic voltage supply (GND)

When used with IO-Link

Pin	Function
1	L+ IO-Link power supply (24 V DC)
2	Reserved, do not connect
3	C/Q communication with the IO-Link master
4	L – Reference potential, IO-Link power supply (0 V)
5	Reserved, do not connect
6	Reserved, do not connect
7	Reserved, do not connect
8	L – Reference potential, IO-Link power supply (0 V)

## Datasheet

## Sizing example

Application data:

- Mass moment of inertia: 100 kgcm<sup>2</sup>
- Mounting position: horizontal
- Rotation angle: 180°
- Max. permitted positioning time: 1 s (one direction)

Step 1: Selecting the possible size from the table → page 8

## Mechanical data

Size	25	32
Permissible mass moment of inertia [kgcm <sup>2</sup> ]	65	164

→ Smallest possible size: ERMS-32-180

Step 2: Selecting the max. speed level v for mass moment of inertia

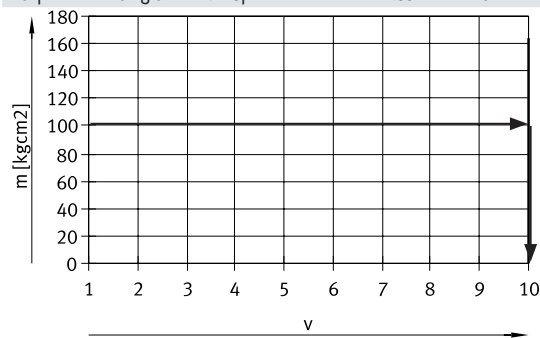

→ Max. speed level for payload: level 10

Step 3: Reading off the min. positioning time t for rotation angle

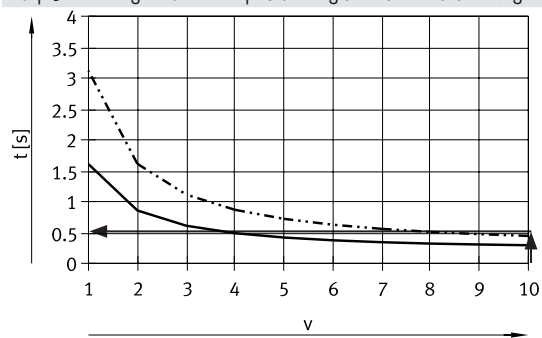

— 90°  
 - - - 180°

→ Min. positioning time for 180° at level 10: 0.5 s

## Result

The application can be implemented using ERMS-32-180. A minimum positioning time (one direction) of 0.5 s is achieved. Longer positioning times can be selected at any time using a lower speed level.

Datasheet

Mass moment of inertia  $m$  as a function of speed level  $v$

Size 25

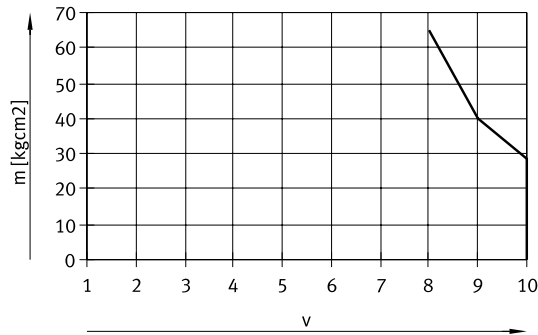

Size 32

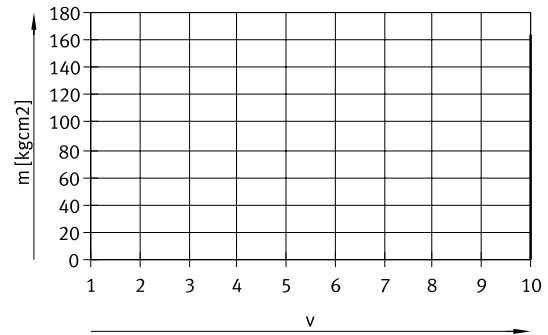

Positioning time  $t$  as a function of speed level  $v$  and rotation angle

Size 25

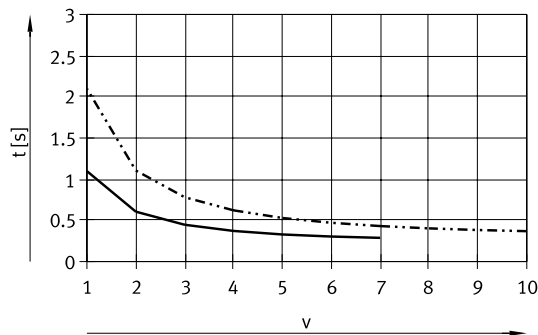

Size 32

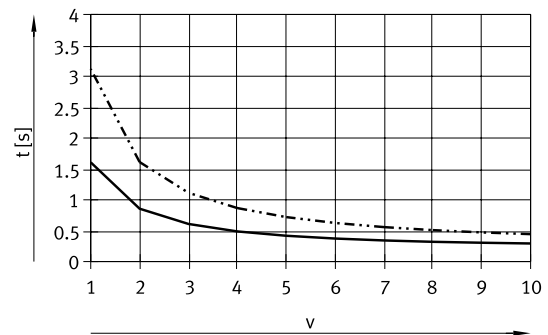

— 90°  
- - - 180°

— 90°  
- - - 180°

Torque  $M$  as a function of force level  $F1$

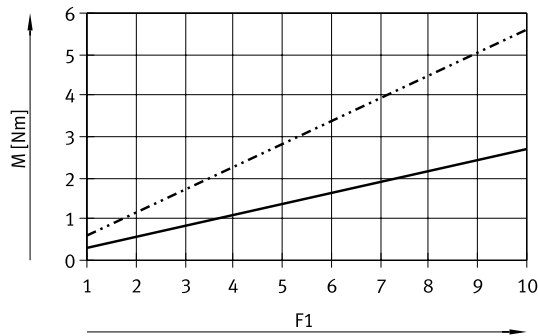

— ERMS-25  
- - - ERMS-32

Datasheet

Max. permissible axial and radial force  $F_x/F_z$

Size		25		32
<b>Static</b>				
Axial force $F_x$	[N]	700		800
Radial force $F_z$	[N]	1200		2000
<b>Dynamic</b>				
Axial force $F_x$	[N]	350		450
Radial force $F_z$	[N]	450		550

Max. dynamic axial force  $F_x$  as a function of lever arm  $l$

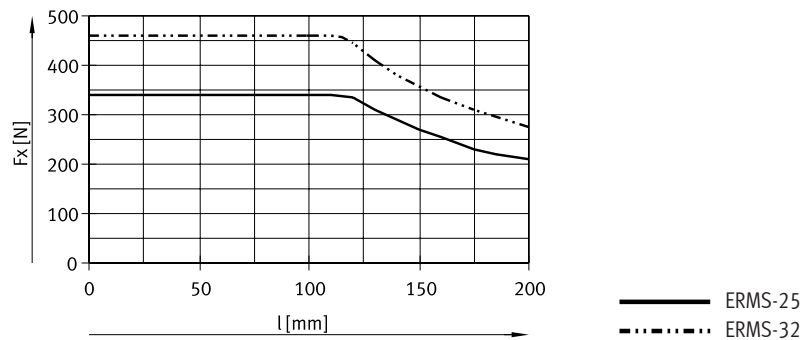
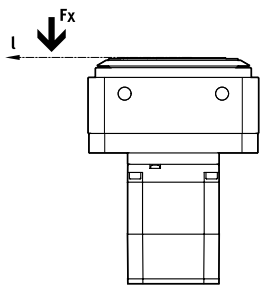

Max. dynamic radial force  $F_z$  as a function of lever arm  $l$

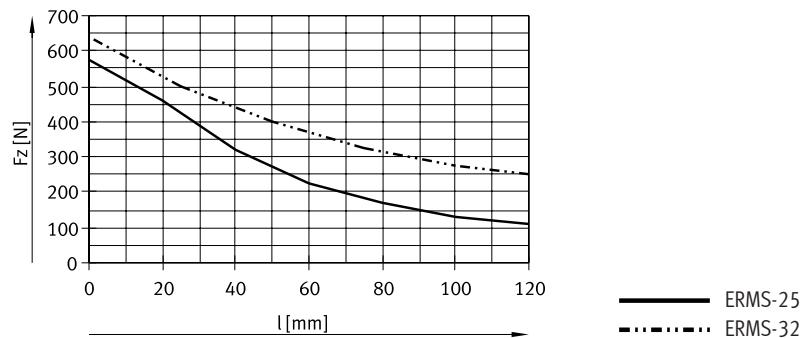
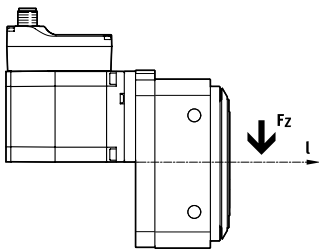

Datasheet

**Axial eccentricity and concentricity**

Axial eccentricity

Measured on the surface of the rotating plate at the plate edge, in new condition.

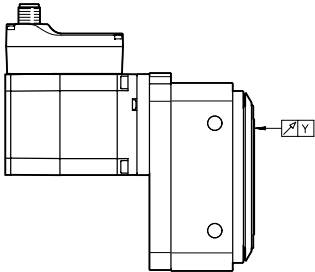

Concentricity

Measured at the centring hole of the rotating plate, when new.

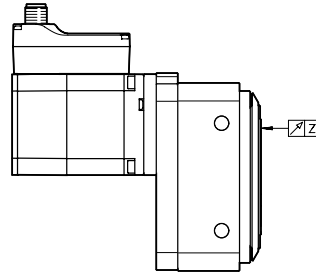

Size		25	32
Axial eccentricity Y	[mm]	<0.02	<0.04
Concentricity Z	[mm]	<0.02	<0.04

Datasheet

Dimensions

Download CAD data → [www.festo.com](http://www.festo.com)  
ERMS-32-...

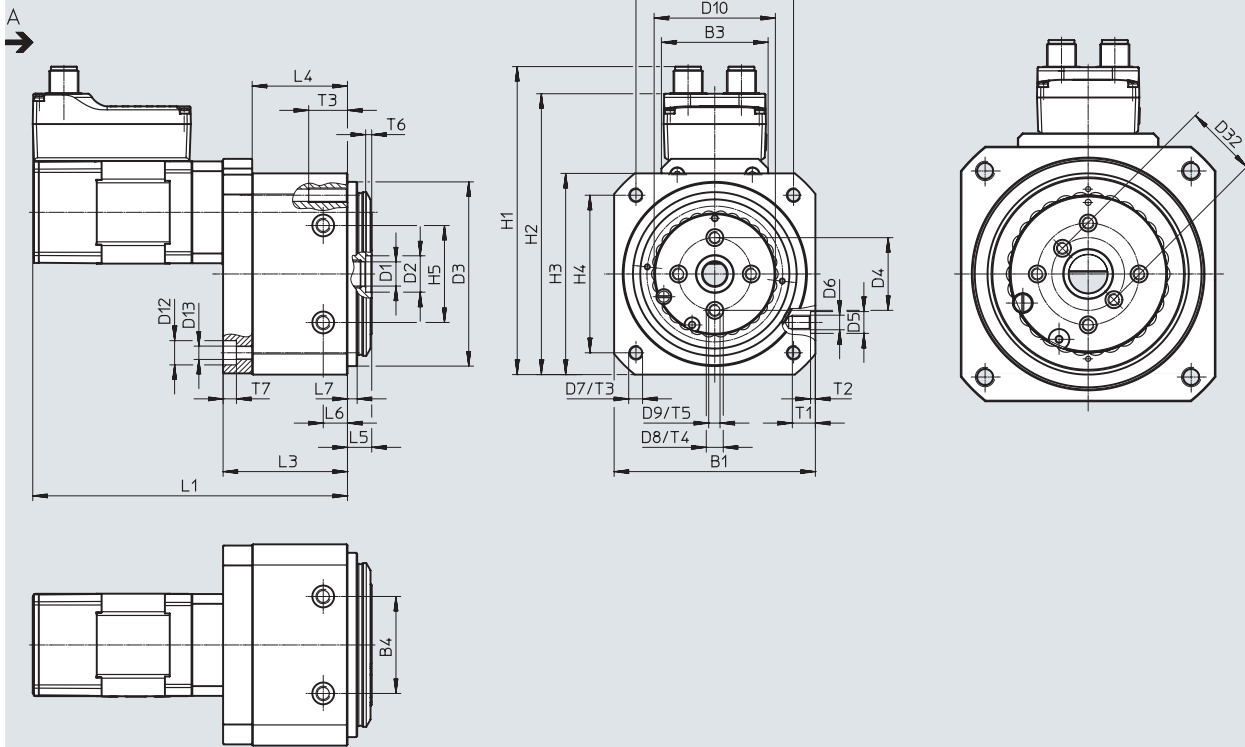

View A

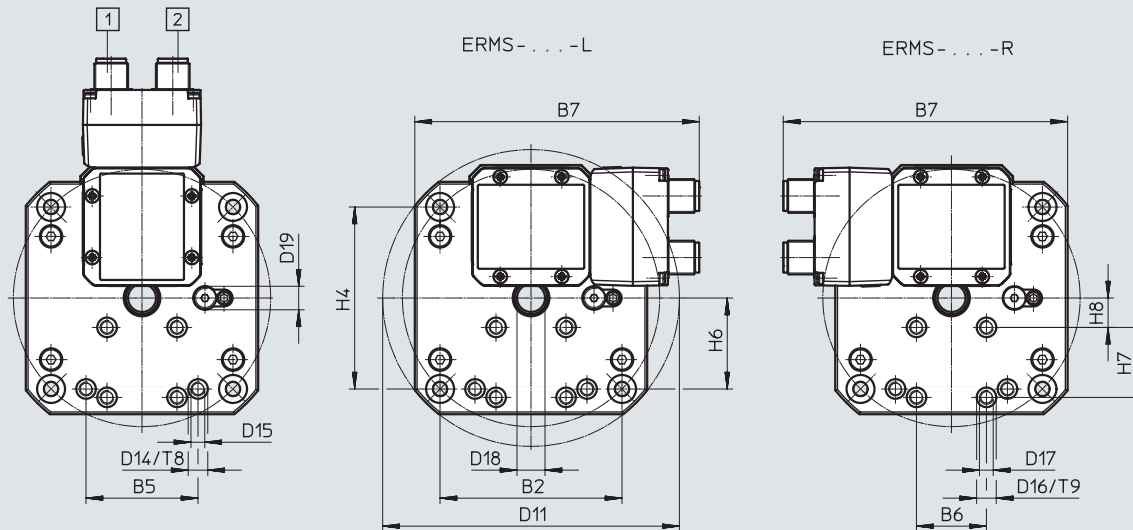

- [1] Connection to logic interface
- [2] Connection for power supply



## Datasheet

Size	B1 ±0.3	B2	B3	B4 ±0.03	B5 ±0.02	B6 ±0.02	B7	D1 ∅	D2 ∅ H8	D3 ∅ f8	D4 ∅ ±0.02
25	83	65	44	40	40	25	101.6	10	15	76	30
32	105	85	58	60	–	25	120	16	20	96	42

Size	D5 ∅ H7	D6	D7	D8 ∅ H7	D9	D10 ∅	D11 ∅ ±0.5	D12 ∅	D13 ∅	D14 ∅ H7	D15
25	9	M6	M6	7	M5	50	106	10	5.5	7	M5
32	12	M8	M8	7	M5	65	135	11	6.6	–	–

Size	D16 ∅ H7	D17	D18 max.	D19	D32 ±0.02	H1	H2	H3 ±0.3	H4	H5 ±0.03
25	7	M5	10	M8x1	–	127.1	115.9	83	65	40
32	7	M5	9	M8x1	30	149	137.8	105	85	60

Size	H6	H7 ±0.02	H8	L1 ±1.5	L3 ±0.6	L4	L5 ±0.2	L6 ±0.1	L7 ±0.1	T1
25	32.5	25	10.5	129.8	51.3	39.3	10	10	4	9.5
32	–	25	15	127	46.5	34.5	12	10	6	15

Size	T2 +0.1	T3	T4 +0.1	T5	T6 +0.1	T7	T8	T9
25	2	16	1.5	8.5	2.5	5.5	1.5	1.5
32	2.5	20	1.5	10	2.8	6.8	–	1.5

## Ordering data

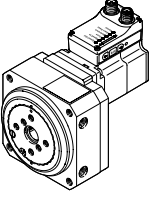
Ordering data	Size	Rotation angle	Part no.	Type
	25	90°	<b>8087819</b>	<b>ERMS-25-90-ST-M-H1-PLK-AA</b>
		180	<b>8087820</b>	<b>ERMS-25-180-ST-M-H1-PLK-AA</b>
	32	90°	<b>8087821</b>	<b>ERMS-32-90-ST-M-H1-PLK-AA</b>
		180°	<b>8087822</b>	<b>ERMS-32-180-ST-M-H1-PLK-AA</b>

## Ordering data – Modular product system



Ordering table					
Size	25	32	Conditions	Code	Enter code
Module no.	8087808	8087809			
Series	ERMS			<b>ERMS</b>	ERMS
Size	25	32		-...	
Nominal swivel angle [°]	90, 180	90, 180		-...	
Motor type	Stepper motor ST			<b>-ST</b>	-ST
Controller	Integrated			<b>-M</b>	-M
Operator panel	Integrated			<b>-H1</b>	-H1
Bus protocol/control	NPN and IO-Link			<b>-NLK</b>	
	PNP and IO-Link			<b>-PLK</b>	
End-position sensing	With integrated end-position sensing			<b>-AA</b>	-AA
Cable outlet direction	Standard				
	Left			<b>-L</b>	
	Right			<b>-R</b>	
Electrical accessories	None				
	Adapter for operation as IO device			<b>+L1</b>	

## Accessories

Ordering data – Centring sleeves					Datasheets → Internet: zbh
	For size	Description	Part no.	Type	PU <sup>1)</sup>
	25	For centring the drive for lateral mounting	<b>8137184</b>	<b>ZBH-9-B</b>	10
	32		<b>8137185</b>	<b>ZBH-12-B</b>	
	25, 32	For centring attachments on the rotating plate	<b>8146544</b>	<b>ZBH-7-B</b>	
	25	For centring attachments in the middle of the rotating plate	<b>191409</b>	<b>ZBH-15</b>	

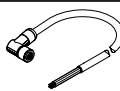
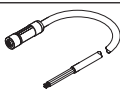
1) Packaging unit

Ordering data – Supply cables					Datasheets → Internet: nebl
	Electrical connection, left	Electrical connection, right	Cable length [m]	Part no.	Type
	Angled socket, M12x1, 4-pin	Cable, open end, 4-wire	2	<b>8080778</b>	<b>NEBL-T12W4-E-2-N-LE4</b>
			5	<b>8080779</b>	<b>NEBL-T12W4-E-5-N-LE4</b>
			10	<b>8080780</b>	<b>NEBL-T12W4-E-10-N-LE4</b>
			15	<b>8080781</b>	<b>NEBL-T12W4-E-15-N-LE4</b>
	Straight socket, M12x1, 4-pin	Cable, open end, 4-wire	2	<b>8080790</b>	<b>NEBL-T12G4-E-2-N-LE4</b>
			5	<b>8080791</b>	<b>NEBL-T12G4-E-5-N-LE4</b>
			10	<b>8080792</b>	<b>NEBL-T12G4-E-10-N-LE4</b>
			15	<b>8080793</b>	<b>NEBL-T12G4-E-15-N-LE4</b>

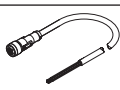
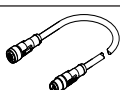
Ordering data – Connecting cables					Datasheets → Internet: nebc
	Electrical connection, left	Electrical connection, right	Cable length [m]	Part no.	Type
	Angled socket, M12x1, 8-pin	Cable, open end, 8-wire	2	<b>8094476</b>	<b>NEBC-M12W8-E-2-N-B-LE8</b>
			5	<b>8094478</b>	<b>NEBC-M12W8-E-5-N-B-LE8</b>
			10	<b>8094481</b>	<b>NEBC-M12W8-E-10-N-B-LE8</b>
			15	<b>8094479</b>	<b>NEBC-M12W8-E-15-N-B-LE8</b>
	Straight plug, M12x1, 8-pin	Cable, open end, 8-wire	2	<b>8080786</b>	<b>NEBC-M12W8-E-2-N-M12G8</b>
			5	<b>8080787</b>	<b>NEBC-M12W8-E-5-N-M12G8</b>
			10	<b>8080788</b>	<b>NEBC-M12W8-E-10-N-M12G8</b>
			15	<b>8080789</b>	<b>NEBC-M12W8-E-15-N-M12G8</b>
	Straight socket, M12x1, 8-pin	Cable, open end, 8-wire	2	<b>8094480</b>	<b>NEBC-M12G8-E-2-N-B-LE8</b>
			5	<b>8094477</b>	<b>NEBC-M12G8-E-5-N-B-LE8</b>
			10	<b>8094482</b>	<b>NEBC-M12G8-E-10-N-B-LE8</b>
			15	<b>8094475</b>	<b>NEBC-M12G8-E-15-N-B-LE8</b>
	Straight plug, M12x1, 8-pin	Cable, open end, 8-wire	2	<b>8080782</b>	<b>NEBC-M12G8-E-2-N-M12G8</b>
			5	<b>8080783</b>	<b>NEBC-M12G8-E-5-N-M12G8</b>
			10	<b>8080784</b>	<b>NEBC-M12G8-E-10-N-M12G8</b>
			15	<b>8080785</b>	<b>NEBC-M12G8-E-15-N-M12G8</b>

 **Note**  
The cables are positioned at a 45° angle to the axis.

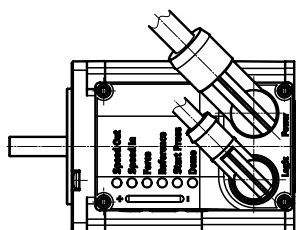

## Accessories

Ordering data – IO-Link master USB					Datasheets → Internet: cdsu
	Description	Cable length [m]	Part no.	Type	
	<ul style="list-style-type: none"> <li>For using the unit with IO-Link</li> <li>An external power supply plug is also required (not included in the scope of delivery)</li> </ul>	0.3	<b>8091509</b>	<b>CDSU-1</b>	

Ordering data – Adapter					Datasheets → Internet: nefc
	Electrical connection, left	Electrical connection, right	Cable length [m]	Part no.	Type
	Straight socket, M12x1, 8-pin	Straight plug, M12x1, 5-pin	0.3	<b>8080777</b>	<b>NEFC-M12G8-0.3-M12G5-LK</b>

# Festo - Your Partner in Automation



**1 Festo Inc.**  
5300 Explorer Drive  
Mississauga, ON L4W 5G4  
Canada

**Festo Customer Interaction Center**  
Tel: 1 877 463 3786  
Fax: 1 877 393 3786  
Email: [customer.service.ca@festo.com](mailto:customer.service.ca@festo.com)



**2 Festo Pneumatic**  
Av. Ceylán 3,  
Col. Tequesquináhuac  
54020 Tlalnepantla,  
Estado de México

**Multinational Contact Center**  
01 800 337 8669  
[ventas.mexico@festo.com](mailto:ventas.mexico@festo.com)



**3 Festo Corporation**  
1377 Motor Parkway  
Suite 310  
Islandia, NY 11749

**Festo Customer Interaction Center**  
1 800 993 3786  
1 800 963 3786  
[customer.service.us@festo.com](mailto:customer.service.us@festo.com)



**4 Regional Service Center**  
7777 Columbia Road  
Mason, OH 45040

Connect with us



[www.festo.com/socialmedia](http://www.festo.com/socialmedia)



[www.festo.com](http://www.festo.com)

Subject to change