

Exhaust air flow control valve, flow control/silencer GRU, GRE

FESTO

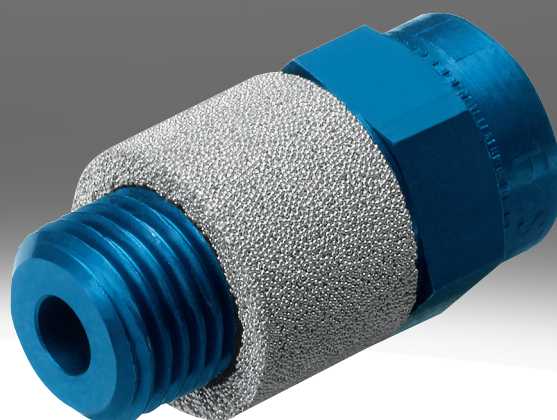

Characteristics

At a glance



Screw-in exhaust air control with silencer function.

- Exhaust air flow control valve GRE: sintered metal
- Flow control/silencer GRU: polymer

Type code

001	Series	
GRE	Exhaust air flow control valve	
GRU	Flow control/silencer	

002	Pneumatic connection	
1/8	Male thread G1/8	
1/4	Male thread G1/4	
3/8	Male thread G3/8	
1/2	Male thread G1/2	
3/4	Male thread G3/4	

003	Generation	
	None	
B	Series B	

Datasheet

Technical data – Exhaust air flow control valves GRE

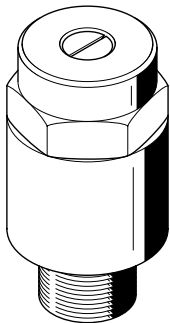

Valve function	Sound pressure control function		
Pneumatic connection, port 1	G1/8	G1/4	G3/8
Adjustment component	Slotted head screw		
Type of mounting	Screw-in		
Mounting position	optional		
Nominal torque	12 Nm	–	
Tolerance for nominal tightening torque	± 20%	–	
Max. tightening torque	–	15 Nm	–
Operating pressure	–	0 ... 10 bar	
Operating pressure complete temperature range	0 ... 10 bar	–	
Operating medium	Compressed air to ISO 8573-1:2010 [7:::]		Compressed air to ISO 8573-1:2010 [7:4:4]
Note on operating and pilot medium	Lubricated operation possible (in which case lubricated operation will always be required)		
Ambient temperature	-10 ... 70°C		
Media temperature	-10 ... 70°C		
Material adjusting screw	Brass		
Material screwed plug	Wrought aluminium alloy		
Material seals	NBR		
Note on materials	RoHS-compliant		
LABS (PWIS) conformity	VDMA24364-B1/B2-L		

Datasheet

Technical data – Flow control/silencer GRU

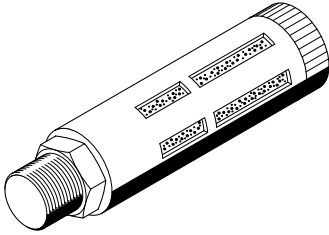

Valve function	Sound pressure control function				
Pneumatic connection, port 1	G1/8	G1/4	G3/8	G1/2	G3/4
Adjustment component	Slotted head screw				
Type of mounting	Screw-in				
Mounting position	optional				
Operating pressure complete temperature range	0 ... 10 bar				
Operating medium	Compressed air to ISO 8573-1:2010 [7:-:]				
Note on operating and pilot medium	Lubricated operation possible				
Ambient temperature	-10 ... 70°C				
Media temperature	-10 ... 70°C				
Material adjusting screw	PA				
Material screwed plug	Die-cast aluminium				
Note on materials	RoHS-compliant				
LABS (PWIS) conformity	VDMA24364-B1/B2-L				

Dimensions

Dimensions – Exhaust air flow control valves GRE

Download CAD data → www.festo.com

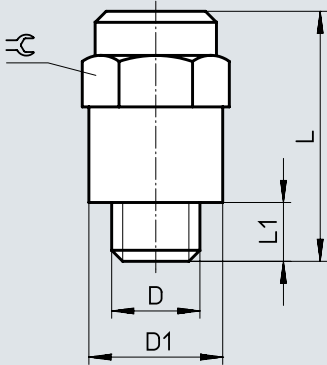

	D	D1	L	L1	☞
GRE-1/8	G1/8	15	27,1	5,1	14
GRE-1/4	G1/4	18,2	32,1	6,1	17
GRE-3/8	G3/8	25	41,1	7,1	22
GRE-1/2	G1/2	27	44,6	8,6	24

Dimensions

Dimensions – Flow control/silencer GRU

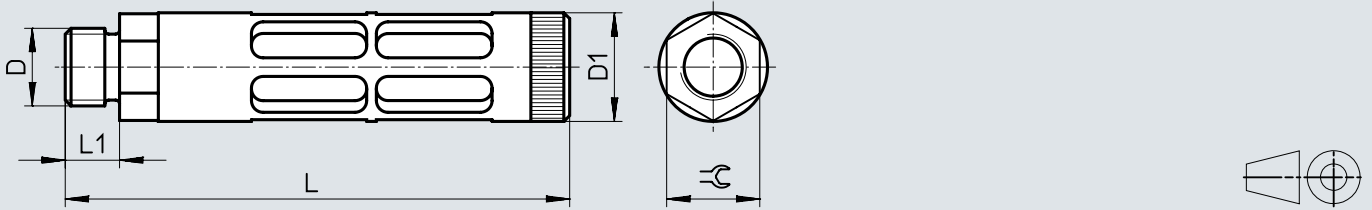
Download CAD data → www.festo.com

	D	D1	L	L1	≅
GRU-1/8-B	G1/8	16	45,9	5,4	14
GRU-1/4-B	G1/4	19,5	63,3	6,4	17
GRU-3/8-B	G3/8	25	95,3	7,5	19
GRU-1/2-B	G1/2	28	130	14	24
GRU-3/4-B	G3/4	38	157,2	16	32

Ordering data

Ordering data – Exhaust air flow control valves GRE

	Pneumatic connection, port 1	Standard flow rate 0.6- >0 MPa (6->0 bar, 87->0 psi)	Product weight	Part no.	Type
	G1/8	0 ... 520 l/min	15 g	10351	GRE-1/8
	G1/4	0 ... 996 l/min	25 g	10352	GRE-1/4
	G3/8	3 ... 2000 l/min	50 g	35310	GRE-3/8
	G1/2	0 ... 4300 l/min	75 g	10353	GRE-1/2

Ordering data – Flow control/silencer GRU

	Pneumatic connection, port 1	Standard flow rate 0.6- >0 MPa (6->0 bar, 87->0 psi)	Product weight	Part no.	Type
	G1/8	0 ... 1000 l/min	10 g	9516	GRU-1/8-B
	G1/4	0 ... 1500 l/min	25 g	9517	GRU-1/4-B
	G3/8	0 ... 1700 l/min	55 g	9518	GRU-3/8-B
	G1/2	0 ... 4000 l/min	100 g	9519	GRU-1/2-B
	G3/4	0 ... 8000 l/min	170 g	9520	GRU-3/4-B