

Membrane air dryers MS-LDM1, MS series

FESTO



Key features

Service unit components of the MS series

Solutions for every application

With its large product range, highly effective components and a wide choice of functions, the MS series from Festo offers a complete concept for compressed air preparation. It is suitable for simple standard applications as well as application-specific solutions with very high quality requirements. Available as individual components, pre-assembled combinations ex-stock,

application-specific combinations or complete turnkey solutions. The five sizes in the MS series achieve maximum flow rates with minimum space requirements.

Freely combinable function modules

Pressure regulators, on/off and soft-start valves with safety function, filters, pressure and flow sensors, dryers, sensors and lubricators can be assembled into a suitable solution for every task. The modular structure enables the components to be combined as required. The simple connection system saves time because the entire combination doesn't need to be disassembled

when replacing individual modules.

Many of the components are also UL and ATEX certified.

CAD models and configurator

Convenient tools for planning and selecting application-specific individual devices and combinations. The product configurator lets you configure customised solutions quickly and transfer the order data without any hassle.

Engineering tools

Selection tool for choosing the right combination of service unit components without oversizing, and with the right air purity class:

→ www.festo.com/engineering/service-unit

Air quality

This program supports configuring an appropriate service unit. Please insert the required air cleanliness either by your application or an ISO-code or by direct selection of air filters.

Integrated sensors

Pressure and flow sensors



- Maximum machine availability thanks to controlled processes
- Reliable air preparation and supply for systems
- Integrated or stand-alone
- Easy to connect with M8/M12 plug

Safety functions

Soft-start/quick exhaust valves

MS6-SV/MS9-SV



- Fast and reliable exhausting of systems up to Performance Level e, certified to EN ISO 13849-1
- Integrated soft-start function

Saving energy

Service unit combinations MSE6



- Fully automatic monitoring and regulation of compressed air supply
- Automatic shut-off of the compressed air in stand-by mode
- Detection and notification of leaks
- Condition monitoring of relevant process data

Intelligent mix of sizes



- Optimum flow rate with a size that is up to 18% smaller
- Excellent energy efficiency
- Cost-optimised combinations – save up to 30%!

Size differences

Size	MS2	MS4	MS6	MS9	MS12
Grid dimension [mm]	25	40	62	90	124
Connection sizes	M5, QS-6	G1/8, G1/4, G3/8	G1/4, G3/8, G1/2, G3/4	G1/2, G3/4, G1, G1 1/4, G1 1/2	G1, G1 1/4, G1 1/2, G2
Standard nominal flow rate q_{N1} [l/min]	350	1800	6500	20000	22000

1) Using pressure regulator MS-LR as an example

Key features

Note

Information

The next few pages provide a brief overview of the product range for the MS series service unit components.

You can find detailed information and all the technical data in the documentation for the relevant service unit component.





Accessories such as connecting plates or mounting brackets can be ordered either via the configurator or separately.

Design of a service unit combination







The order of the individual service unit components within a combination is relevant for safety and functionality. The service unit components cannot be combined in any order in the flow direction. They are subject to restrictions and rules.

The configurator for the service unit combination MSB is a reliable and convenient way of arranging individual service unit components and ensures compliance with the applicable rules. As a result, you get a completely assembled combination with UL or ATEX certification, if necessary. When combining a unit from individually configured and ordered service unit components, the following points must be adhered to under all circumstances.







- Regulators MS-LFR/LR/LRP/LRE are only permissible in the flow direction with the same or decreasing pressure regulation range
- Filters MS-LFR/LF/LFM/LFX are only permissible in the flow direction with an increasing grade of filtration
- Lubricators MS-LOE are not permitted in the flow direction upstream of a filter MS-LFR/LFM/LF/LFX, water separator MS-LWS or membrane air dryer MS-LDM1
- A micro filter MS-LFM must be installed in the flow direction upstream of an activated carbon filter MS-LFX or membrane air dryer MS-LDM1
- A flow sensor SFAM cannot be installed directly downstream of a regulator MS-LFR/LR; a branching module MS-FRM must be positioned between them
- A soft-start/quick exhaust valve MS-SV must be the last service unit component in the flow direction

Product range for MS series service unit components								
Type	Description	Size	Pneumatic connection					
			Push-in connector	Female thread			Connecting plate with thread	
				M	G	NPT	G	NPT
Combinations								
Service unit combinations MSB-FRC								Datasheets → Internet: msb
	Combinations of filter regulator and lubricator	4	–	–	1/8, 1/4	–	–	–
		6	–	–	1/4, 3/8, 1/2	–	–	–
Service unit combinations MSB								
Service unit combinations MSB								Datasheets → Internet: msb
	7 predefined combinations	4	–	–	1/4	–	–	–
		6	–	–	1/2	–	–	–
	Freely configurable combinations	4	–	–	1/8, 1/4	–	1/8, 1/4, 3/8	1/8, 1/4, 3/8
		6	–	–	1/4, 3/8, 1/2	–	1/4, 3/8, 1/2, 3/4	1/4, 3/8, 1/2, 3/4
		9	–	–	3/4, 1	3/4, 1	1/2, 3/4, 1, 1 1/4, 1 1/2	1/2, 3/4, 1, 1 1/4, 1 1/2
Service unit combinations MSE6								
Service unit combinations MSE6								Datasheets → Internet: mse6
	Combinations with fieldbus connection for measuring pressure, flow rate and consumption	6	–	–	–	–	1/2	–





Key features

Product range for MS series service unit components								
Type	Description	Size	Pneumatic connection				Connecting plate with thread	
			Push-in connector	Female thread			G	NPT
			M	G	NPT	G	NPT	
Individual devices								
Filter regulators MS-LFR			Datasheets → Internet: ms2-lfr; ms4-lfr; ms6-lfr; ms9-lfr; ms12-lfr					
	Filter and pressure regulator in a single device, grade of filtration 5 or 40 µm	2	QS-6	M5	–	–	–	–
		4	–	–	1/8, 1/4	–	1/8, 1/4, 3/8	1/8, 1/4, 3/8
		6	–	–	1/4, 3/8, 1/2	–	1/4, 3/8, 1/2, 3/4	1/4, 3/8, 1/2, 3/4
		9	–	–	3/4, 1	3/4, 1	1/2, 3/4, 1, 1 1/4, 1 1/2	1/2, 3/4, 1, 1 1/4, 1 1/2
		12	–	–	–	–	1, 1 1/4, 1 1/2, 2	–
Filter regulators MS-LFR-B			Datasheets → Internet: ms4-lfr-b; ms6-lfr-b					
	Filter and pressure regulator in a single device in polymer housing, grade of filtration 5 or 40 µm	4	–	–	1/4	–	–	–
		6	–	–	1/2	–	–	–
Filters MS-LF			Datasheets → Internet: ms4-lf; ms6-lf; ms9-lf; ms12-lf					
	Grade of filtration 5 or 40 µm	4	–	–	1/8, 1/4	–	1/8, 1/4, 3/8	1/8, 1/4, 3/8
		6	–	–	1/4, 3/8, 1/2	–	1/4, 3/8, 1/2, 3/4	1/4, 3/8, 1/2, 3/4
		9	–	–	3/4, 1	3/4, 1	1/2, 3/4, 1, 1 1/4, 1 1/2	1/2, 3/4, 1, 1 1/4, 1 1/2
		12	–	–	–	–	1, 1 1/4, 1 1/2, 2	–
Fine and micro filters MS-LFM			Datasheets → Internet: ms4-lfm; ms6-lfm; ms9-lfm; ms12-lfm					
	Grade of filtration 0.01 or 1 µm	4	–	–	1/8, 1/4	–	1/8, 1/4, 3/8	1/8, 1/4, 3/8
		6	–	–	1/4, 3/8, 1/2	–	1/4, 3/8, 1/2, 3/4	1/4, 3/8, 1/2, 3/4
		9	–	–	3/4, 1	3/4, 1	1/2, 3/4, 1, 1 1/4, 1 1/2	1/2, 3/4, 1, 1 1/4, 1 1/2
		12	–	–	–	–	1, 1 1/4, 1 1/2, 2	–
Activated carbon filters MS-LFX			Datasheets → Internet: ms4-lfx; ms6-lfx; ms9-lfx; ms12-lfx					
	For removing liquid and gaseous oil particles	4	–	–	1/8, 1/4	–	1/8, 1/4, 3/8	1/8, 1/4, 3/8
		6	–	–	1/4, 3/8, 1/2	–	1/4, 3/8, 1/2, 3/4	1/4, 3/8, 1/2, 3/4
		9	–	–	3/4, 1	3/4, 1	1/2, 3/4, 1, 1 1/4, 1 1/2	1/2, 3/4, 1, 1 1/4, 1 1/2
		12	–	–	–	–	1, 1 1/4, 1 1/2, 2	–
Water separators MS-LWS			Datasheets → Internet: ms6-lws; ms9-lws; ms12-lws					
	Remove condensate from compressed air, maintenance-free	6	–	–	1/4, 3/8, 1/2	–	1/4, 3/8, 1/2, 3/4	1/4, 3/8, 1/2, 3/4
		9	–	–	3/4, 1	3/4, 1	1/2, 3/4, 1, 1 1/4, 1 1/2	1/2, 3/4, 1, 1 1/4, 1 1/2
		12	–	–	–	–	1, 1 1/4, 1 1/2, 2	–





Key features

Product range for MS series service unit components								
Type	Description	Size	Pneumatic connection					
			Push-in connector	Female thread			Connecting plate with thread	
				M	G	NPT	G	NPT
Individual devices								
Pressure regulators MS-LR Datasheets → Internet: ms2-lr; ms4-lr; ms6-lr; ms9-lr; ms12-lr								
	For setting the required operating pressure, 4 pressure regulation ranges	2	QS-6	M5	–	–	–	–
		4	–	–	1/8, 1/4	–	1/8, 1/4, 3/8	1/8, 1/4, 3/8
		6	–	–	1/4, 3/8, 1/2	–	1/4, 3/8, 1/2, 3/4	1/4, 3/8, 1/2, 3/4
		9	–	–	3/4, 1	3/4, 1	1/2, 3/4, 1, 1 1/4, 1 1/2	1/2, 3/4, 1, 1 1/4, 1 1/2
		12	–	–	–	–	1, 1 1/4, 1 1/2, 2	–
Pressure regulators MS-LR-B Datasheets → Internet: ms4-lr-b; ms6-lr-b								
	For setting the required operating pressure, in polymer housing	4	–	–	1/4	–	–	–
		6	–	–	1/2	–	–	–
Pressure regulators MS-LRB Datasheets → Internet: ms4-lrb; ms6-lrb								
	For configuring a regulator manifold with independent pressure regulation ranges. Pressure output is to the front or rear.	4	–	–	1/4	–	1/8, 1/4, 3/8	–
		6	–	–	1/2	–	1/4, 3/8, 1/2, 3/4	–
Precision pressure regulators MS-LRP Datasheets → Internet: ms6-lrp								
	For precisely setting the required operating pressure, 4 pressure regulation ranges, pressure hysteresis 0.02 bar	6	–	–	1/4, 3/8, 1/2	–	1/4, 3/8, 1/2, 3/4	1/4, 3/8, 1/2, 3/4
Precision pressure regulators MS-LRPB Datasheets → Internet: ms6-lrpb								
	For configuring a regulator manifold with independent pressure regulation ranges. Pressure output is to the front or rear.	6	–	–	1/2	–	1/4, 3/8, 1/2, 3/4	–
Lubricators MS-LOE Datasheets → Internet: ms4-loe; ms6-loe; ms9-loe; ms12-loe								
	Add a precisely adjustable amount of oil to the compressed air. The amount of oil mist is proportional to the compressed air flow rate.	4	–	–	1/8, 1/4	–	1/8, 1/4, 3/8	1/8, 1/4, 3/8
		6	–	–	1/4, 3/8, 1/2	–	1/4, 3/8, 1/2, 3/4	1/4, 3/8, 1/2, 3/4
		9	–	–	3/4, 1	3/4, 1	1/2, 3/4, 1, 1 1/4, 1 1/2	1/2, 3/4, 1, 1 1/4, 1 1/2
		12	–	–	–	–	1, 1 1/4, 1 1/2, 2	–

Key features

Product range for MS series service unit components								
Type	Description	Size	Pneumatic connection			Connecting plate with thread		
			Push-in connector	Female thread		G		NPT
			M	G	NPT	G	NPT	
Individual devices								
On/off valves MS-EM						Datasheets → Internet: ms4-em; ms6-em; ms9-em; ms12-em		
	Manually actuated on/off valve for pressurising and exhausting pneumatic systems.	4	–	–	1/8, 1/4	–	1/8, 1/4, 3/8	1/8, 1/4, 3/8
		6	–	–	1/4, 3/8, 1/2	–	1/4, 3/8, 1/2, 3/4	1/4, 3/8, 1/2, 3/4
		9	–	–	3/4, 1	3/4, 1	1/2, 3/4, 1, 1 1/4, 1 1/2	1/2, 3/4, 1, 1 1/4, 1 1/2
		12	–	–	–	–	1, 1 1/4, 1 1/2, 2	–
On/off valves MS-EE								
On/off valves MS-EE						Datasheets → Internet: ms4-ee; ms6-ee; ms9-ee; ms12-ee		
	Electrically actuated on/off valve for pressurising and exhausting pneumatic systems.	4	–	–	1/8, 1/4	–	1/8, 1/4, 3/8	1/8, 1/4, 3/8
		6	–	–	1/4, 3/8, 1/2	–	1/4, 3/8, 1/2, 3/4	1/4, 3/8, 1/2, 3/4
		9	–	–	3/4, 1	3/4, 1	1/2, 3/4, 1, 1 1/4, 1 1/2	1/2, 3/4, 1, 1 1/4, 1 1/2
		12	–	–	–	–	1, 1 1/4, 1 1/2, 2	–
On/off valves MS-EE-B								
On/off valves MS-EE-B						Datasheets → Internet: ms4-ee-b; ms6-ee-b		
	Electrically actuated on/off valve in polymer housing for pressurising and exhausting pneumatic systems.	4	–	–	1/4	–	–	–
		6	–	–	1/2	–	–	–
Soft-start valves MS-DL								
Soft-start valves MS-DL						Datasheets → Internet: ms4-dl; ms6-dl; ms12-dl		
	Pneumatically actuated soft-start valve for slowly pressurising and exhausting pneumatic systems.	4	–	–	1/8, 1/4	–	1/8, 1/4, 3/8	1/8, 1/4, 3/8
		6	–	–	1/4, 3/8, 1/2	–	1/4, 3/8, 1/2, 3/4	1/4, 3/8, 1/2, 3/4
		12	–	–	–	–	1, 1 1/4, 1 1/2, 2	–
Soft-start valves MS-DE								
Soft-start valves MS-DE						Datasheets → Internet: ms4-de; ms6-de; ms12-de		
	Electrically actuated soft-start valve for slowly pressurising and exhausting pneumatic systems.	4	–	–	1/8, 1/4	–	1/8, 1/4, 3/8	1/8, 1/4, 3/8
		6	–	–	1/4, 3/8, 1/2	–	1/4, 3/8, 1/2, 3/4	1/4, 3/8, 1/2, 3/4
		12	–	–	–	–	1, 1 1/4, 1 1/2, 2	–
On/off valves MS-EDE-B								
On/off valves MS-EDE-B						Datasheets → Internet: ms4-edeb; ms6-edeb		
	Electrically actuated soft-start valve in polymer housing for slowly pressurising and exhausting pneumatic systems.	4	–	–	1/4	–	–	–
		6	–	–	1/2	–	–	–
Soft-start/quick exhaust valves MS-SV								
Soft-start/quick exhaust valves MS-SV						Datasheets → Internet: ms6-sv; ms9-sv		
	For building up pressure gradually and reducing pressure quickly and safely in pneumatic piping systems. Up to category 1, PL c.	6	–	–	1/2	–	1/4, 3/8, 1/2, 3/4	1/4, 3/8, 1/2, 3/4
		9	–	–	3/4, 1	3/4, 1	1/2, 3/4, 1, 1 1/4, 1 1/2	1/2, 3/4, 1, 1 1/4, 1 1/2
	Up to category 3, PL d. Up to category 4, PL e in the case of optional extension.	6	–	–	1/2	–	1/4, 3/8, 1/2, 3/4	1/4, 3/8, 1/2, 3/4
	Up to category 4, PL e.	6	–	–	1/2	–	1/4, 3/8, 1/2, 3/4	–

Key features

Product range for MS series service unit components								
Type	Description	Size	Pneumatic connection					
			Push-in connector	Female thread			Connecting plate with thread	
				M	G	NPT	G	NPT
Individual devices								
Membrane air dryers MS-LDM1 Datasheets → Internet: ms4-ldm; ms6-ldm								
	Wear-free membrane dryer with internal air consumption	4	–	–	1/8, 1/4	–	1/8, 1/4, 3/8	1/8, 1/4, 3/8
		6	–	–	1/4, 3/8, 1/2	–	1/4, 3/8, 1/2, 3/4	1/4, 3/8, 1/2, 3/4
Branching modules MS-FRM Datasheets → Internet: ms4-frm; ms6-frm; ms9-frm; ms12-frm								
	Compressed air distributors with 4 connections	4	–	–	1/8, 1/4	–	1/8, 1/4, 3/8	–
		6	–	–	1/4, 3/8, 1/2	–	1/4, 3/8, 1/2, 3/4	–
		9	–	–	3/4, 1	3/4, 1	1/2, 3/4, 1, 1 1/4, 1 1/2	1/2, 3/4, 1, 1 1/4, 1 1/2
		12	–	–	–	–	1, 1 1/4, 1 1/2, 2	–
Distributor blocks MS-FRM-FRZ Datasheets → Internet: ms4-frm-frz; ms6-frm-frz								
	Compressed air distributors with 4 connections and half the grid width	4	–	–	–	–	–	–
		6	–	–	–	–	–	–
Flow sensors SFAM Datasheets → Internet: sfam								
	For absolute flow rate information and cumulative air consumption measurement	6	–	–	–	–	1/2	1/2
		9	–	–	–	–	1, 1 1/2	1, 1 1/2

Peripherals overview

Membrane air dryer MS4/MS6-LDM1

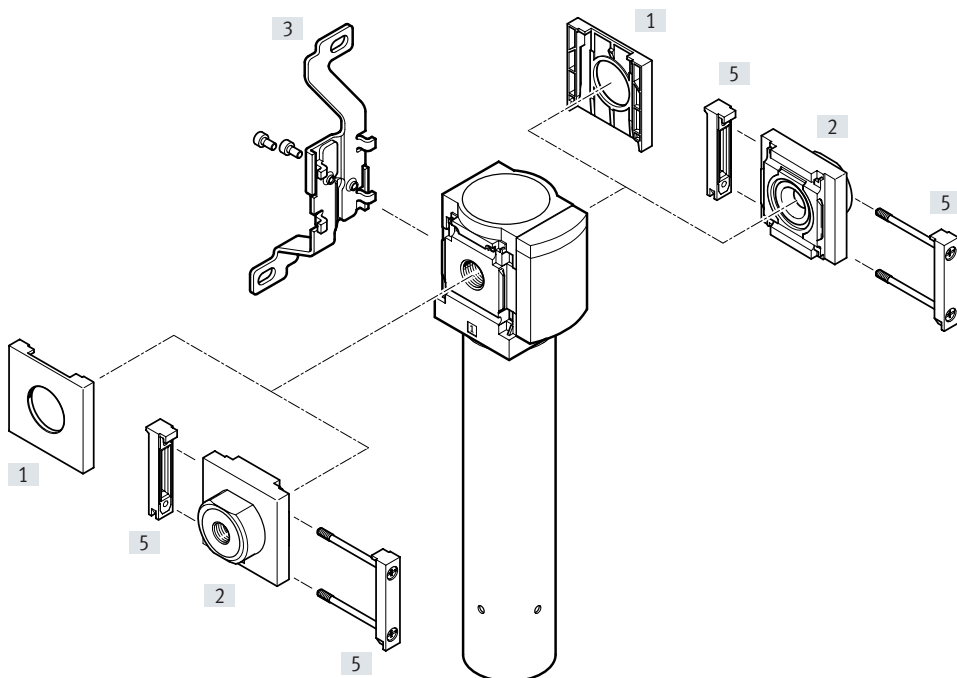

Note

Additional accessories:

- Module connector for combination with size MS4/MS6 or size MS9
→ Internet: amv, rmv, armv
- Adapter for mounting on profiles
→ Internet: ipm-80, ipm-40-80, ipm-80-80

Mounting attachments and accessories

	Individual device		Combination		→ Page/ Internet
	Without connecting plate	With connecting plate	Without connecting plate	With connecting plate	
[1] Cover cap MS4/6-END	■	–	■	–	ms4-end, ms6-end
[2] Connecting plate SET MS4/6-AG...	–	■	–	■	ms4-ag, ms6-ag
Connecting plate SET MS4/6-AQ...	–	■	–	■	ms4-aq, ms6-aq
[3] Mounting bracket MS4/6-WB	■	■	–	–	ms4-wb, ms6-wb
[5] Module connector MS4/6-MV	–	■	■	■	ms4-mv, ms6-mv
– Mounting bracket MS4-WBM	■	■	–	–	ms4-wbm
– Mounting bracket MS4/6-WP/WPB/WPE/WPM	–	■	■	■	ms4-wp, ms6-wp

Type codes

MS4-LDM1

001	Series
MS4	MS series, size 4
002	Function
LDM1	Membrane air dryer
003	Pneumatic connection
1/8	Female thread G1/8
1/4	Female thread G1/4
AGA	Sub-base G1/8
AGB	Sub-base G1/4
AGC	Sub-base G3/8
AQK	Sub-base 1/8 NPT
AQN	Sub-base 1/4 NPT
AQP	Sub-base 3/8 NPT
004	Flow cartridge
P05	50 l/min
P10	100 l/min
005	Purge air
	Unducted
PAC	Ducted

006	Type of mounting
	Without mounting bracket
WP	Mounting bracket basic design
WPM	Mounting bracket for hooking in service unit components
WB	Mounting centrally at rear (wall mounting top and bottom), connecting plates not required
WBM	Mounting centrally at rear (wall mounting top), connecting plates not required
007	EU certification
	None
EX4	II 2GD
008	UL certification
	None
UL1	cULus ordinary location for Canada and USA
009	Flow direction
	Flow direction from left to right
Z	Flow direction from right to left

MS6-LDM1



001	Series
MS6	MS-series, size 6
002	Function
LDM1	Membrane air dryer
003	Pneumatic connection
1/4	Female thread G1/4
3/8	Female thread G3/8
1/2	Female thread G1/2
AGB	Sub-base G1/4
AGC	Sub-base G3/8
AGD	Sub-base G1/2
AGE	Sub-base G3/4
AQN	Sub-base 1/4 NPT
AQP	Sub-base 3/8 NPT
AQR	Sub-base 1/2 NPT
AQS	Sub-base 3/4 NPT
004	Flow cartridge
P20	200 l/min
P30	300 l/min
P40	400 l/min

005	Purge air
	Unducted
PAC	Ducted
006	Type of mounting
	Without mounting bracket
WP	Mounting bracket basic design
WPM	Mounting bracket for hooking in service unit components
WB	Mounting centrally at rear (wall mounting top and bottom), connecting plates not required
007	EU certification
	None
EX4	II 2GD
008	UL certification
	None
UL1	cULus ordinary location for Canada and USA
009	Flow direction
	Flow direction from left to right
Z	Flow direction from right to left

Datasheet

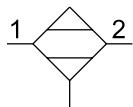
Function



-  - Flow rate
50 ... 400 l/min
-  - Temperature range
+2 ... +50°C
-  - Operating pressure
3 ... 12.5 bar

Pressure dew point reduction:
20 K



- Optimum final dryer with excellent operational reliability
- Suitable for use as an individual device or for integration into existing service unit combinations
- Flow rate-dependent dew point reduction
- Wear-free function requiring no external energy

- The composition of the compressed air remains almost unchanged due to the drying process
- 15% purge air flow rate
- Optional purge ring for ducting the purge air
- Optional device variant EX4 for use in potentially explosive areas in zones 1, 2, 21 and 22

Typical areas of application:

- Drying, cleaning of precision parts
- Measurement technology
- Rinsing of precision glass scales
- Painting systems
- Paper and packaging machines



Note

Prefiltration of the compressed air using a micro filter MS-LFM-A, grade of filtration 0.01 µm (residual particles < 0.1 µm, residual oil content < 0.1 mg/m³) is vital for correct functioning of the component.

General technical data

Size	MS4	MS6
Pneumatic connection 1, 2		
Female thread	G1/8 or G1/4	G1/4, G3/8 or G1/2
Connecting plate	[AG...] [AQ...]	G1/8, G1/4 or G3/8 1/8 NPT, 1/4 NPT or 3/8 NPT
Connecting plate		G1/4, G3/8, G1/2 or G3/4 1/4 NPT, 3/8 NPT, 1/2 NPT or 3/4 NPT
Design	Membrane dryer with internal air consumption	
Type of mounting	Via accessories In-line installation	
Mounting position	Vertical ±5°	
Air purity class at the output	Compressed air to ISO 8573-1:2010 [1:3:2]	

† Note: This product conforms to ISO 1179-1 and ISO 228-1.

Standard flow rate q_{n1} [l/min]

Size	MS4			MS6		
	P05	P10	P20	P30	P40	
Input $q_{n\ in}$	59	118	235	353	471	
Output $q_{n\ out}$	50	100	200	300	400	
Purge air $q_{n\ purge}$	8.8	17.6	35.3	52.9	70.6	

1) Measured at $p_1 = 6.9\ \text{bar}$, $\theta_{pd\ in} = 25^\circ\text{C}$, $\theta_{pd\ out} = 5^\circ\text{C} \pm 1.5^\circ\text{C}$ ($\theta_{pa\ out} = -21.5^\circ\text{C} \pm 1.2^\circ\text{C}$), $\theta_{amb} = 25^\circ\text{C}$

Datasheet

Operating and environmental conditions		
Operating pressure [bar]		3 ... 12.5 (3 ... 10) ¹⁾
Operating medium		Compressed air to ISO 8573-1:2010 [1:4:2]
Note on the operating/ pilot medium		Lubricated operation not possible
Pressure dew point reduction [K]		20
Ambient temperature [°C]		+2 ... +50
Temperature of medium [°C]		+2 ... +50
Storage temperature [°C]		-20 ... +60
Corrosion resistance class CRC ²⁾		2
Food-safe ³⁾		See supplementary material information
UL certification ³⁾		c UL us - Recognized (OL)

1) Value in brackets applies to MS4/MS6-LDM1 with UL certification.

 2) More information www.festo.com/x/topic/crc

 3) More information: www.festo.com/catalogue/ms-ldm → Support/Downloads.

ATEX	
EU certification	EX4
ATEX category for gas	II 2G
Type of (ignition) protection for gas	Ex h IIC T6 Gb X
ATEX category for dust	II 2D
Type of (ignition) protection for dust	Ex h IIIC T60°C Db X
Explosion ambient temperature	+2°C ≤ Ta ≤ +50°C
Explosion protection certification outside the EU	EPL Db (GB) EPL Gb (GB)
CE marking (see declaration of conformity) ¹⁾²⁾	To EU Explosion Protection Directive (ATEX)
UKCA marking (see declaration of conformity) ¹⁾²⁾	To UK regulations for explosions

1) Note operating range of proximity switches.

 2) More information: www.festo.com/catalogue/ms-ldm → Support/Downloads.

Weight [g]					
Size	MS4		MS6		
Flow cartridge	P05	P10	P20	P30	P40
Membrane air dryer	420	530	1050	1200	1300

Materials

Sectional view

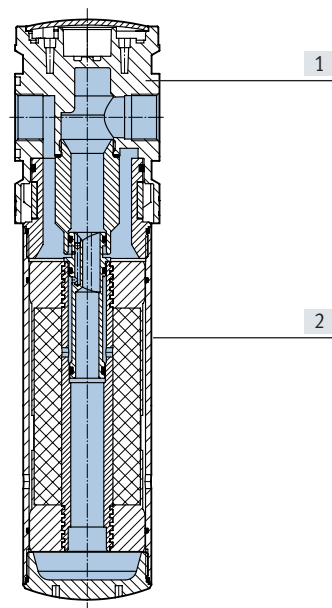

Membrane air dryer		
[1]	Housing	Die-cast aluminium
[2]	Bowl	Wrought aluminium alloy
-	Seals	NBR
Note on materials		RoHS-compliant
LABS (PWIS) conformity		VDMA24364-B1/B2-L

Datasheet

Pressure dew point t_{pd} (output) as a function of standard flow rate at output q_n ¹⁾

MS4-LDM1-...-P05

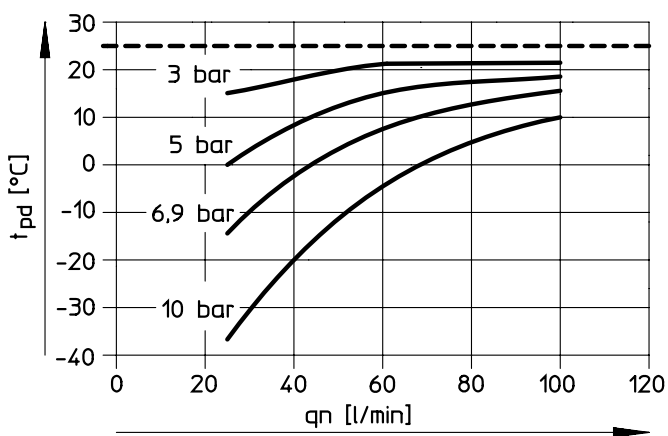

MS4-LDM1-...-P10

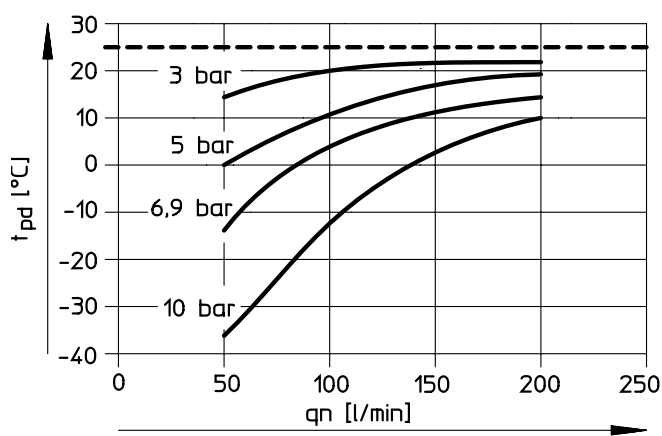

MS6-LDM1-...-P20

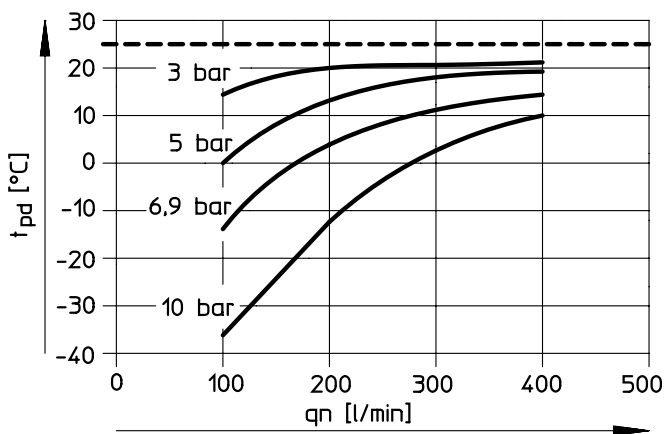

MS6-LDM1-...-P30

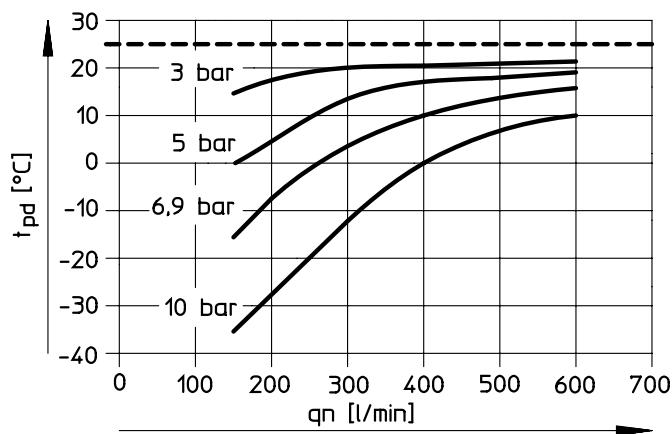

MS6-LDM1-...-P40

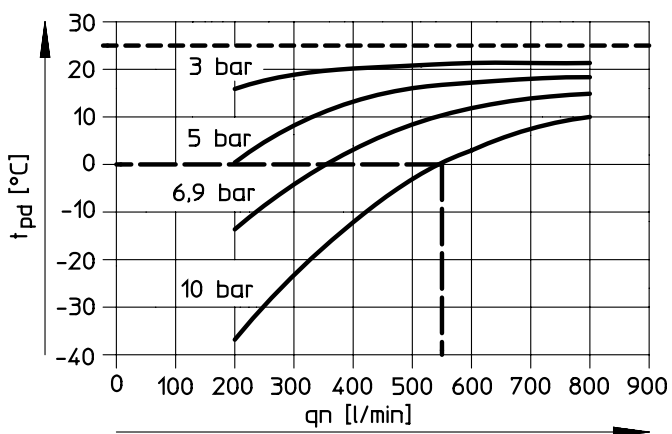

- 1) Measured at pressure dew point t_{pd} (input) = 25°C.
- Example using MS6-LDM1-...-P40 at 10 bar operating pressure: at a standard flow rate of $q_n = 550$ l/min the pressure dew point reduction is 25 K.

Datasheet

Differential pressure Δp as a function of the standard flow rate at output q_n

MS4-LDM1-...-P05

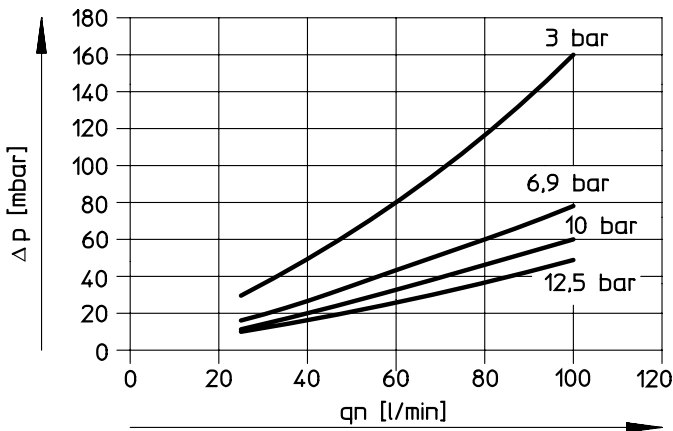

MS4-LDM1-...-P10

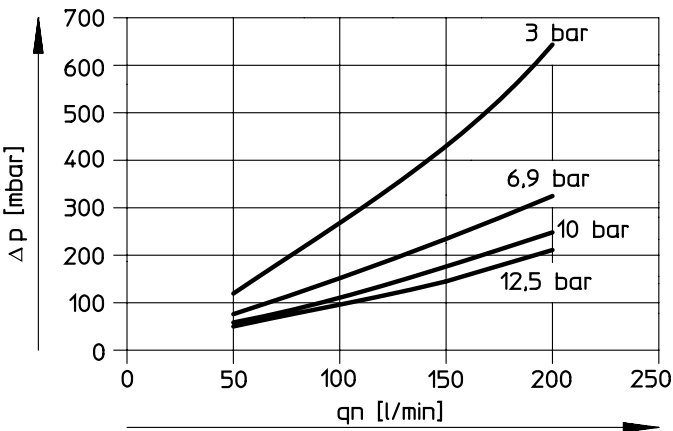

MS6-LDM1-...-P20

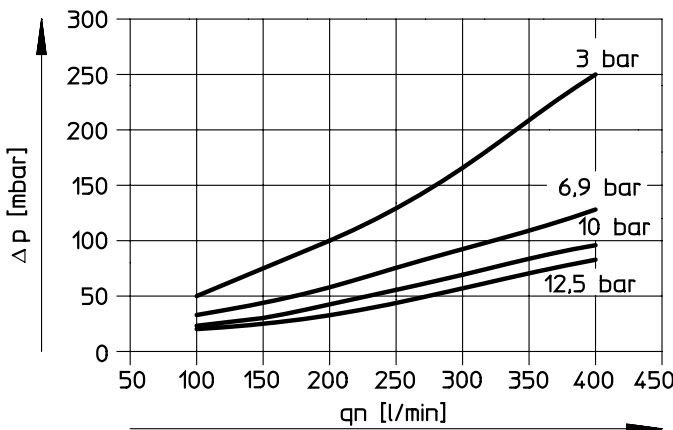

MS6-LDM1-...-P30

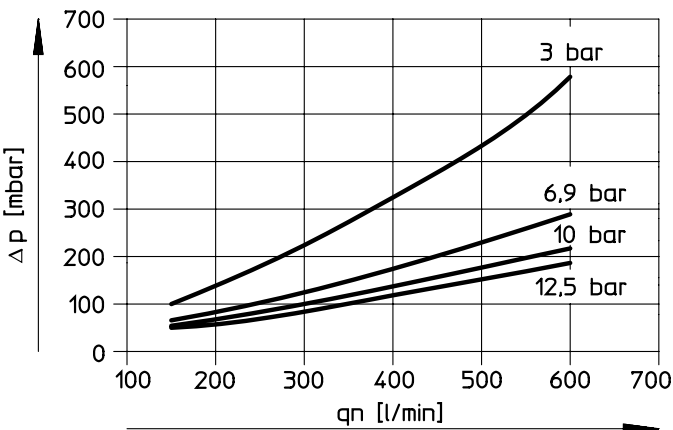

MS6-LDM1-...-P40

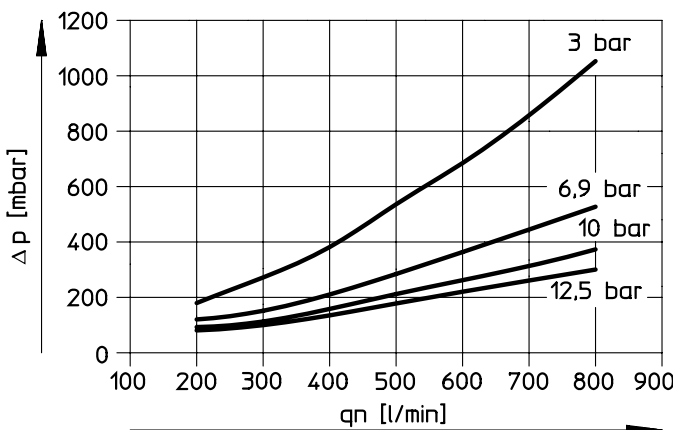

Datasheet

Dimensions

Download CAD data → www.festo.com

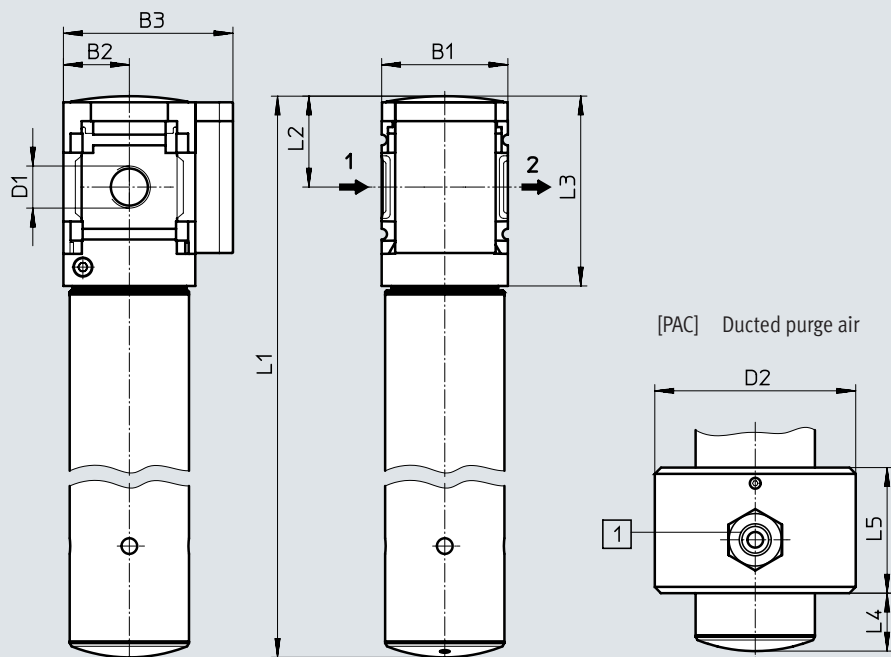

Type	B1	B2	B3	D1	D2	L1	L2	L3	L4	L5
MS4-LDM1-1/8-P05	40	21	54	G1/8	64	245	29	60	18	40
MS4-LDM1-1/8-P10						345				
MS4-LDM1-1/4-P05	40	21	54	G1/4	64	245	29	60	18	40
MS4-LDM1-1/4-P10						345				
MS6-LDM1-1/4-P20	62	31	76	G1/4	80	345	42	87	34	40
MS6-LDM1-1/4-P30						415				
MS6-LDM1-1/4-P40						475				
MS6-LDM1-3/8-P20	62	31	76	G3/8	80	345	42	87	34	40
MS6-LDM1-3/8-P30						415				
MS6-LDM1-3/8-P40						475				
MS6-LDM1-1/2-P20	62	31	76	G1/2	80	345	42	87	34	40
MS6-LDM1-1/2-P30						415				
MS6-LDM1-1/2-P40						475				

† Note: This product conforms to ISO 1179-1 and ISO 228-1.

Ordering data

Size	Flow cartridge	Connection	Part no.	Type
Flow direction from left to right				
MS4	P10	G1/4	543632	MS4-LDM1-1/4-P10
MS6	P20	G1/4	543640	MS6-LDM1-1/4-P20
		G1/2	543644	MS6-LDM1-1/2-P20
	P40	G1/2	543650	MS6-LDM1-1/2-P40
Flow direction from right to left				
MS4	P10	G1/4	543633	MS4-LDM1-1/4-P10-Z

Ordering data – Modular product system

Ordering table		Grid dimension	[mm]	40	62	Conditions	Code	Enter code
Module no.		543628			543638			
Series	Standard						MS	MS
Size	4			6			...	
Function	Membrane air dryer						-LDM1	-LDM1
Pneumatic connection	Female thread G1/8	–				[1]	-1/8	
	Female thread G1/4	Female thread G1/4				[1]	-1/4	
	–	Female thread G3/8				[1]	-3/8	
	–	Female thread G1/2				[1]	-1/2	
	Connecting plate G1/8	–					-AGA	
	Connecting plate G1/4	Connecting plate G1/4					-AGB	
	Connecting plate G3/8	Connecting plate G3/8					-AGC	
	–	Connecting plate G1/2					-AGD	
	–	Connecting plate G3/4					-AGE	
	Connecting plate 1/8 NPT	–				[1]	-AQK	
	Connecting plate 1/4 NPT	Connecting plate 1/4 NPT				[1]	-AQN	
	Connecting plate 3/8 NPT	Connecting plate 3/8 NPT				[1]	-AQP	
	–	Connecting plate 1/2 NPT				[1]	-AQR	
	–	Connecting plate 3/4 NPT				[1]	-AQS	
Flow cartridge	50 l/min	–					-P05	
	100 l/min	–					-P10	
	–	200 l/min					-P20	
	–	300 l/min					-P30	
	–	400 l/min					-P40	
Purge air	Unducted							
	Ducted purge air					[1]	-PAC	
Type of mounting	Without mounting bracket							
	Mounting bracket standard design					[2]	-WP	
	Mounting bracket for hooking in service unit components					[1] [2]	-WPM	
	Mounting bracket centrally at rear (wall mounting top and bottom), connecting plates not required						-WB	
	Mounting bracket centrally at rear (wall mounting top), connecting plates not required	–					-WBM	
EU certification	None							
	II 2GD to EU Explosion Protection Directive (ATEX)						-EX4	
UL certification	None							
	cULus, ordinary location for Canada and USA						-UL1	
Flow direction	Flow direction from left to right							
	Flow direction from right to left						-Z	

[1] 1/8, 1/4, 3/8, 1/2, AQK, AQN, AQP, AQR, AQS, PAC, WPM

[2] WP, WPM Only with connecting plate AGA, AGB, AGC, AGD, AGE, AQK, AQN, AQP, AQR or AQS.

Festo - Your Partner in Automation



1 Festo Inc.
5300 Explorer Drive
Mississauga, ON L4W 5G4
Canada

Festo Customer Interaction Center
Tel: 1 877 463 3786
Fax: 1 877 393 3786
Email: customer.service.ca@festo.com



2 Festo Pneumatic
Av. Ceylán 3,
Col. Tequesquináhuac
54020 Tlalnepantla,
Estado de México

Multinational Contact Center
01 800 337 8669
ventas.mexico@festo.com



3 Festo Corporation
1377 Motor Parkway
Suite 310
Islandia, NY 11749

Festo Customer Interaction Center
1 800 993 3786
1 800 963 3786
customer.service.us@festo.com



4 Regional Service Center
7777 Columbia Road
Mason, OH 45040

Connect with us



www.festo.com/socialmedia



www.festo.com

Subject to change